

MEGApix® 1080p 2.1MP Indoor/ Outdoor Bullet Camera

DWC-MB721M4TIR

DWC-MB721M8TIR



User's Manual Ver. 08/16

Before installing and using the camera, please read this manual carefully.
Be sure to keep it handy for future reference.

Safety Information



CAUTION

RISK OF ELECTRIC SHOCK.
DO NOT OPEN.



CAUTION:

TO REDUCE THE RISK OF ELECTRIC SHOCK, DO NOT REMOVE COVER (OR BACK) NO USER SERVICEABLE PARTS INSIDE. REFER SERVICING TO QUALIFIED SERVICE PERSONNEL.



Warning

This symbol indicates that dangerous voltage consisting a risk of electric shock is present within this unit.



Precaution

This exclamation point symbol is intended to alert the user to the presence of important operating and maintenance (servicing) instructions in the literature accompanying the appliance.

WARNING

To prevent damage which may result in fire or electric shock hazard, do not expose this appliance to rain or moisture.

WARNING

1. Be sure to use only the standard adapter that is specified in the specification sheet. Using any other adapter could cause fire, electrical shock, or damage to the product
2. Incorrectly connecting the power supply or replacing battery may cause explosion, fire, electric shock, or damage to the product.
3. Do not connect multiple cameras to a single adapter. Exceeding the capacity may cause excessive heat generation or fire
4. Securely plug the power cord into the power receptacle. Insecure connection may cause fire
5. When installing the camera, fasten it securely and firmly. A falling camera may cause personal injury.
6. Do not place conductive objects (e.g. screw drivers, coins, metal items, etc.) or containers filled with water on top of the camera. Doing so may cause personal injury due to fire electric shock, or falling objects.
7. Do not install the unit in humid, dusty, or sooty locations. Doing so may cause fire or electric shock
8. If any unusual smells or smoke come from the unit, stop using the product. Immediately disconnect the power source and contact the service center. Continued use in such a condition may cause fire or electric shock
9. If this product fails to operate normally, contact the nearest service center. Never disassemble or modify this product in any way.
10. When cleaning, do not spray water directly onto parts of the product. Doing so may cause fire or electric shock

Precaution

Operating

- Before using, make sure power supply and all other parts are properly connected.
- While operating, if any abnormal condition or malfunction is observed, stop using the camera immediately and contact your dealer.

Handling

- Do not disassemble or tamper with parts inside the camera.
- Do not drop the camera or subject it to shock or vibration as this can damage the camera.
- Clean the clear dome cover with extra care. Scratches and dust can ruin the quality of the camera image.

Installation and Storage

- Do not install the camera in areas of extreme temperature, exceeding the allowed range.
- Avoid installing in humid or dusty environments.
- Avoid installing in places where radiation is present.
- Avoid installing in places where there are strong magnetic fields and electric signals.
- Avoid installing in places where the camera would be subject to strong vibrations.
- Never expose the camera to rain or water.

Important Safety Instructions

1. **Read these instructions.** - All safety and operating instructions should be read before installation or operation.
2. **Keep these instructions.** - The safety, operating and use instructions should be retained for future reference.
3. **Heed all warnings.** - All warnings on the product and in the operating instructions should be adhered to.
4. **Follow all instructions.** - All operating and use instructions should be followed.
5. **Do not use this device near water.** - For example: near a bath tub, wash bowl, kitchen sink, laundry tub, in a wet basement; near a swimming pool; etc.
6. **Clean only with dry cloth.** - Unplug this product from the wall outlet before cleaning. Do not use liquid cleaners.
7. **Do not block any ventilation openings. Install in accordance with the manufacturer's instructions.** - Slots and openings in the cabinet are provided for ventilation, to ensure reliable operation of the product, and to protect it from over-heating. The openings should never be blocked by placing the product on bed, sofa, rug or other similar surfaces. This product should not be placed in a built-in installation such as a bookcase or rack unless proper ventilation is provided and the manufacturer's instructions have been adhere to.
8. **Do not install near any heat sources such as radiators, heat registers, or other apparatus (including amplifiers) that produce heat.**
9. **Do not defeat the safety purpose of the polarized or grounding-type plug.** A polarized plug has two blades with one wider than the other. A grounding type plug has two blades and a third grounding prong. The wide blade or the third prong are provided for your safety. If the provided plug does not fit into your outlet, consult an electrician for replacement.
10. **Protect the power cord from being walked on or pinched particularly at plugs, convenience receptacles, and the point where they exit from the apparatus.**
11. **Only use attachments/accessories specified by the manufacturer.**
12. **Use only with cart, stand, tripod, bracket, or table specified by the manufacturer, or sold with the apparatus. When a cart is used, use caution when moving the cart/apparatus combination to avoid injury from tip-over.**
13. **Unplug the apparatus during lightning storms or when unused for long periods of time.**
14. **Refer all servicing to qualified service personnel. Servicing is required when the apparatus has been damaged in any way, such as power supply cord or plug is damaged, liquid has been spilled or objects have fallen into the apparatus, the apparatus has been exposed to rain or moisture, does not operate normally, or has been dropped.**



Disposal of Old Appliances



1. When this crossed-out wheel bin symbol is attached to a product it means the product is covered by the European Directive 2002/96/EC.
2. All electrical and electronic products should be disposed of separately from the municipal waste stream in accordance to laws designated by the government or the local authorities.
3. The correct disposal of your old appliance will help prevent potential negative consequences for the environment and human health.
4. For more detailed information about disposal of your old appliance, please contact your city office, waste disposal service or the shop where you purchased the product.



This equipment has been tested and found to comply with the limits for a Class A digital device, pursuant to part 15 of the FCC Rules.

These limits are designed to provide reasonable protection against harmful interference when the equipment is operated in a commercial environment.

This equipment generates, uses, and can radiate radio frequency energy and, if not installed and used in accordance with the instruction manual, may cause harmful interference to radio communications. Operation of this equipment in a residential area is likely to cause harmful interference in which case the user will be required to correct the interference at his own expense.

Table of Contents

Introduction

Product & Accessories.....	5
Parts Name.....	6

Installation

Installation.....	7
Factory Reset.....	7
Cabling.....	8
Memory SD Card.....	9

Network Setup

DW IP Finder.....	10
Network Connection Options.....	11-12
DDNS Registration.....	13
Network Environments.....	14-16
Starting the IP Camera.....	17

Web Viewer

GUI Overview.....	18
-------------------	----

Camera Settings

Setup > Video & Audio > Video.....	19-22
Setup > Video & Audio > OSD.....	23
Setup > Video & Audio > ROI.....	24
Setup > Video & Audio > Privacy Mask.....	25
Setup > Camera > Image adjustment and Enhancement.....	26-32
Setup > Network Settings.....	33-40
Setup > Trigger Action.....	41-43
Setup > Events.....	44-46
Setup > Record > Record Configuration.....	47-48
Setup > Record > Recording List.....	49
Setup > Record > Recording Video.....	50
Setup > Record > Storage Configuration.....	51-52
Setup > Security.....	53
Setup > System > System Information.....	54
Setup > System > Firmware Update.....	55-56
Setup > System > Date & Time.....	57
Setup > System > DST Settings.....	58
Setup > System > User Management.....	59
Setup > System > System Log.....	60
Setup > System > Factory Reset.....	61
Setup > System > Restart.....	62

Appendix.....	63-64
----------------------	--------------

FAQs.....	65
------------------	-----------

Dimensions.....	66
------------------------	-----------

Warranty.....	67
----------------------	-----------

Limits & Exclusions.....	68
-------------------------------------	-----------

Introduction - Product & Accessories

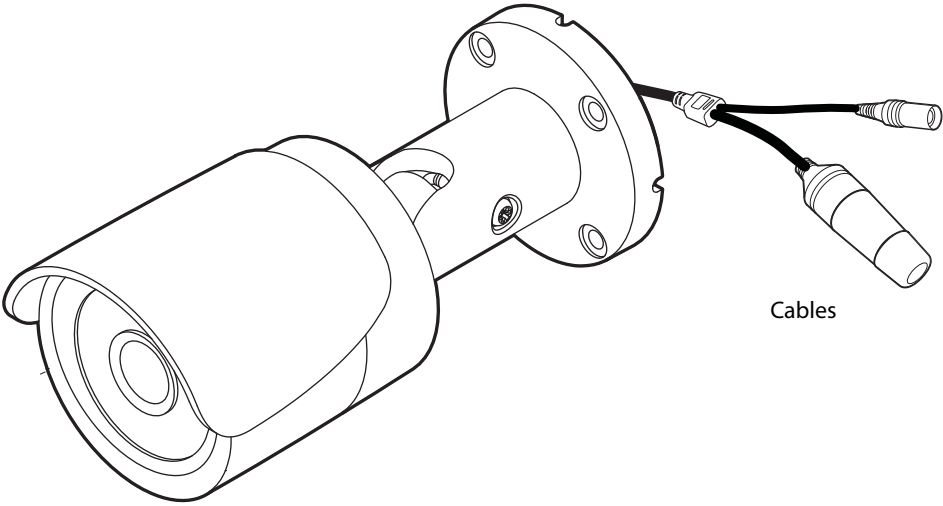

Camera

Cables



Torx Wrench

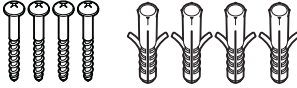

Screw & Plastic Anchor-4pcs



Quick Manual

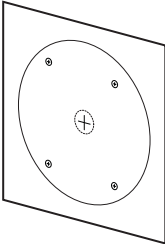

Template Sheet

Introduction - Part Name

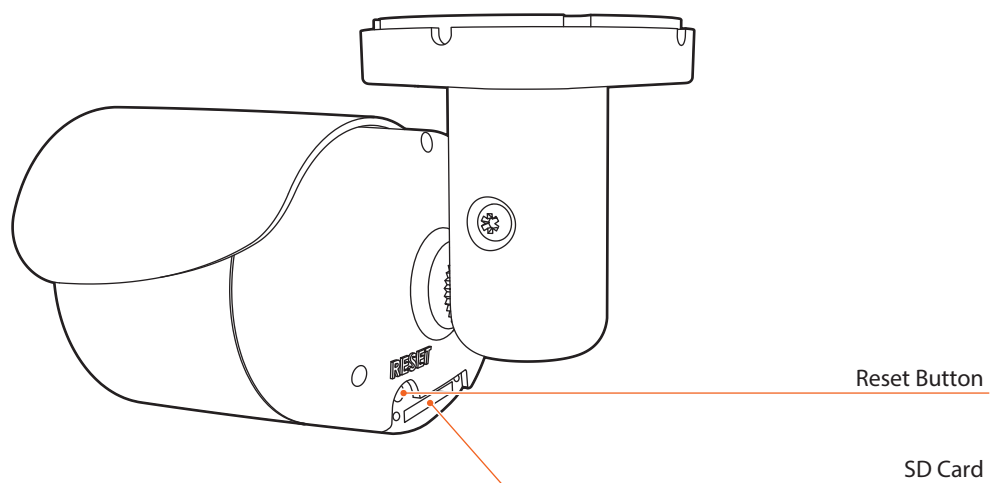
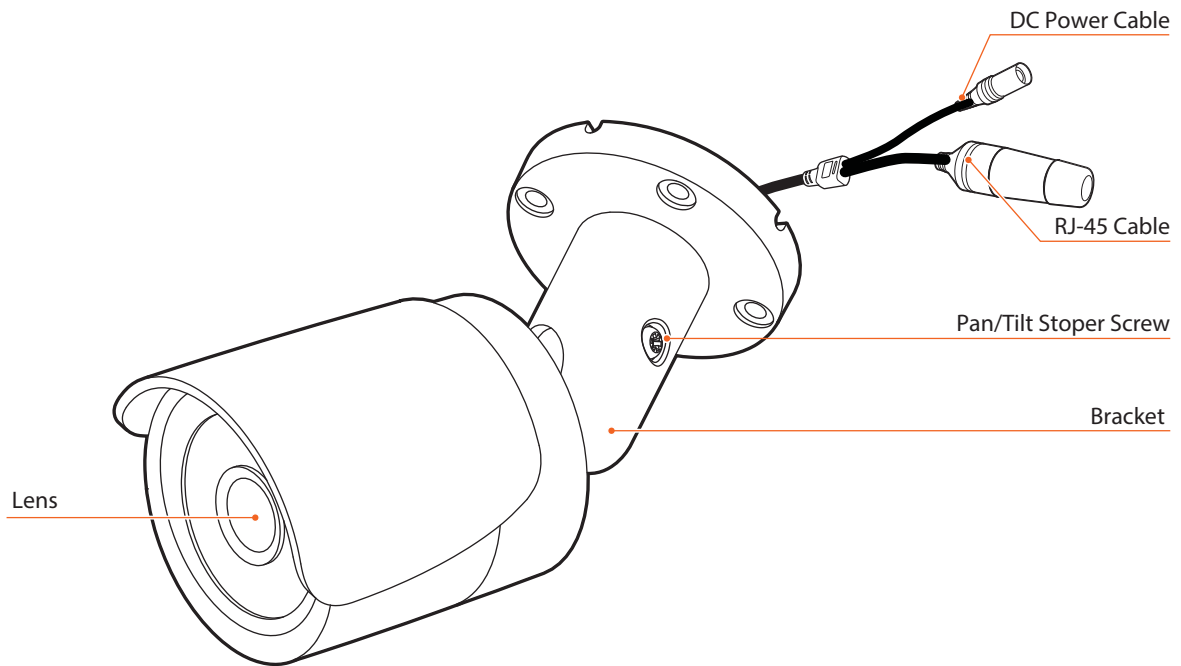

Installation - Installation

Before installing your camera, you have to read the following cautions.

1. You have to check whether the location can bear five times of the weight of your camera.
2. Don't let the cable to be caught in improper place or the electric line cover to be damaged. Otherwise it may cause a breakdown or fire.
3. When installing your camera, don't allow any person to approach the installation site. If you have any valuable things under the place, move them away.

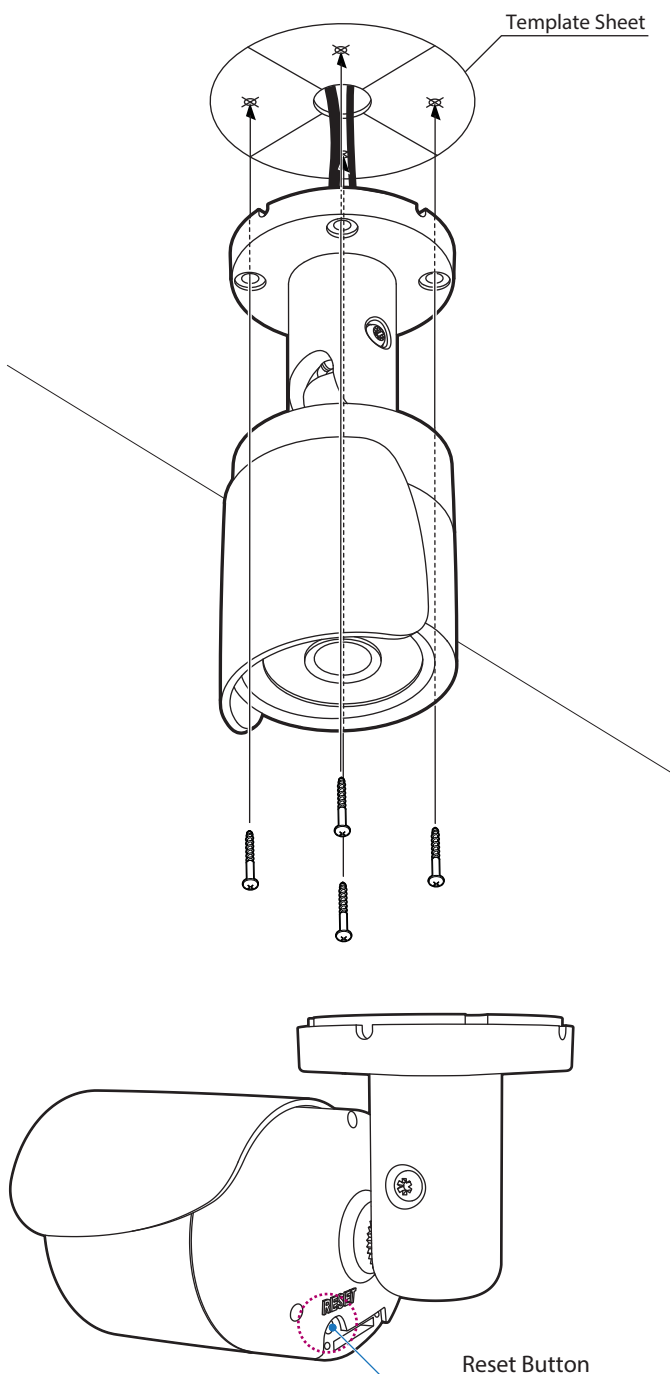

- 1 To pass cables through the wall/ceiling, drill holes on the wall/ceiling.
- 2 Connect the network cable, power cable respectively. See the section 'Installation - Cabling' for details.
 - ⊠ Put the Lan cable into (a), then (b) will be assembled to (a) tightly. As a final step, (c) need to be assembled to (b) without making any space.

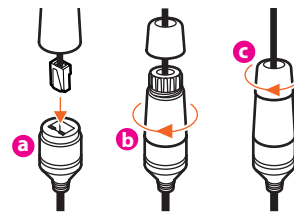

- 3 Fix the camera on the wall/ceiling by screw provided.
 - ⊠ Loosen the Pan/Tilt stopper screw a little before fixing the camera.
- 4 After adjusting the view angle, tighten the Pan/Tilt stopper screw.

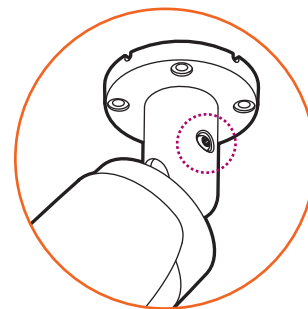

- ⊠ **Reset to the Factory Defaults**
Press the reset button for 5 seconds to return the setup to the Factory Default.
- ⊠ **Warning:**
If you press the 'Reset' button, you will lose all setting data. If needed, please, make a note for further installation.

Installation - Cabling

Two Options

Use a PoE-enabled switch to connect data and power through a single cable and begin viewing and recording images instantly. A non-PoE switch will require an adaptor for power transmission.

1. Using a PoE-Enabled Switch

The Camera is PoE-compliant, allowing transmission of power and data via a single Ethernet cable. PoE eliminates the need for the different cables used to power, record, or control the camera. Follow the illustration below to connect the camera to a PoE-enabled switch using an Ethernet cable.

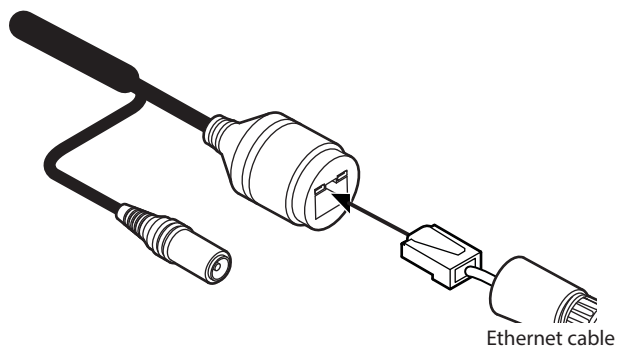

2. Using a Non-PoE Switch

If a PoE-enabled switch is not used, use a power adaptor for power transmission and non-PoE switch for data transmission. Follow the illustrations below to connect the camera without a PoE-enabled Switch.

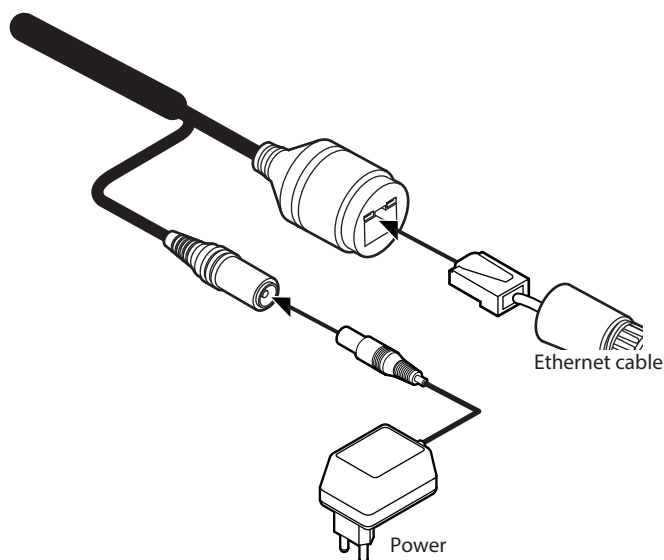

Installation - Inserting/Removing an SD Memory Card

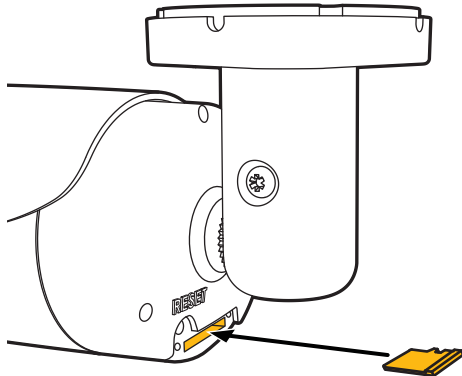

The memory card is an external data storage device that has been developed to offer an entirely new way to record and share video, audio, and text data using digital devices.



⚠ **Recommended SD Card Specification (Not Included)**

- Type: Micro SD (SD/SDHC/SDXC/MMC)
- Manufacturer: Transcend, Kingston, Toshiba, SanDisk
- Capacity: 32G(SDHC), 2T(SDXC)
- Class: over UHS-II U3 Class 10

1 The SD Card slot is located at the back of the camera

2 **Inserting an SD Memory Card**

Insert the SD card in the arrow direction.

- ⚠ Do not insert the SD memory card upside down by force. It may damage the SD memory card.

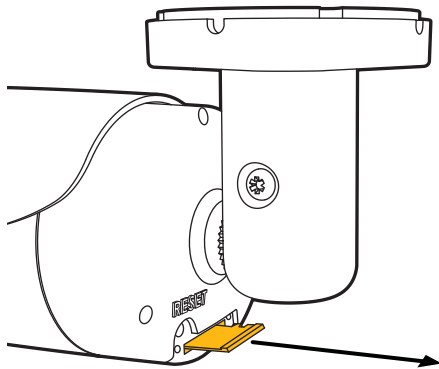

3 **Removing an SD Memory Card**

To remove the card, gently press down on the exposed end of the memory card as shown in the diagram to eject the memory card from the slot.

- ⚠ Pressing too hard on the SD memory card can cause the card to shoot out from the slot when released.
- ⚠ If you have saved data in the SD memory card, removing the SD memory card prior to setting record to OFF will cause damage to the data stored in the card.
- ⚠ See page 58 for additional storage configuration.

Network Setup - DW IP Finder™

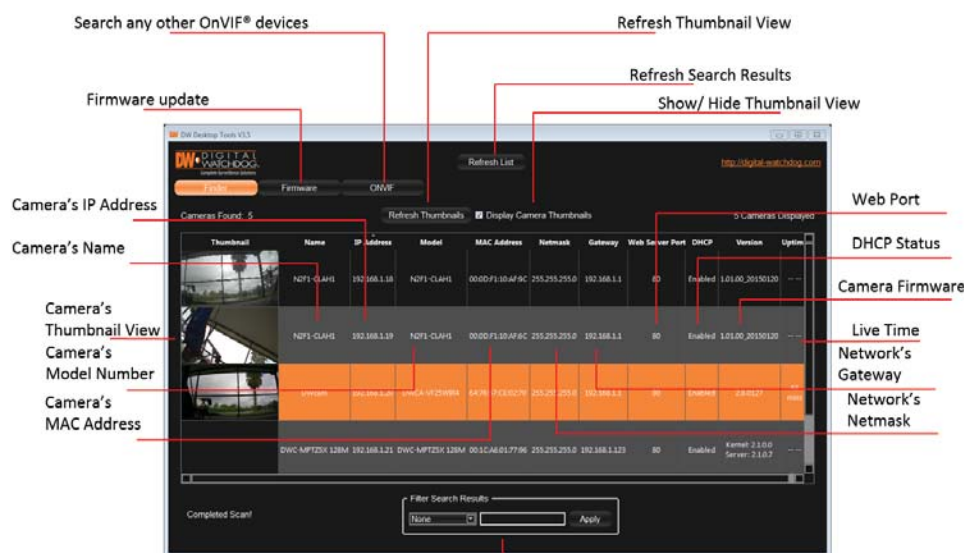

1 Go to: <http://www.digital-watchdog.com> and search for 'IP Finder' on the quick search bar at the top of the page.

2 The latest IP Finder software will appear in the search results. Click on the link to download the file to your computer.

3 The software will scan your network for all supported cameras and display the results in the table. Allow up to 5 seconds for the IP Installer to find the camera on the network.

4 you can press the 'Refresh List' to search the network again, or filter the search results by entering a value in the filter box at the bottom of the page.

5 Check the box next to 'Display Camera Thumbnail' to view a JPEG image of the camera's view next to the camera name on supported models.

1 Select DHCP if the Internet service is dynamic IP. This will allow the camera to receive its IP address from the DHCP server. Select a camera from the list by double-clicking on it. The camera's network information will appear. If necessary, you can adjust the camera's network type. Select STATIC to manually enter the camera's IP address, subnet mask, Gateway and DNS information.

2 Contact your network administrator for more information.

6 The camera's default network information is:

1 Default TCP/IP information
 - IP: 192.168.1.80
 - Subnet Mask: 255.255.255.0
 - Gateway: 192.168.1.1
 - DNS : 168.126.63.1

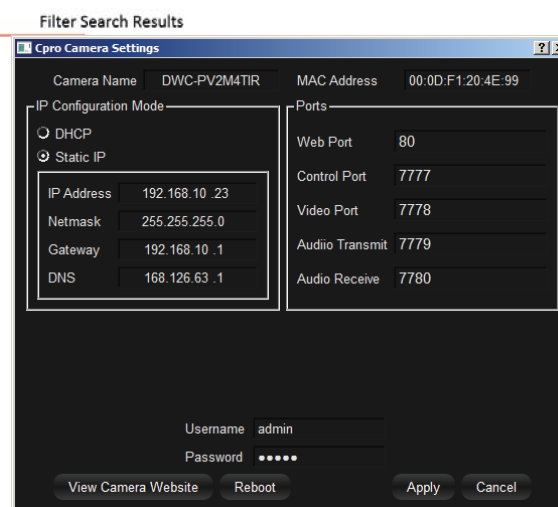

7 To view the camera's web client, click on 'View Camera Website'.

1 A 'Port Forwarding' has to be set in your network's router for external access to the camera.

8 To save the changes made to the camera's settings, input ID and PW of the camera for authentication.

9 If the camera needs to be rebooted after the settings were changed, press the 'Reboot' button. The camera will power cycle and will appear back in the search results once the reboot is complete.

1 Default ID / PW : admin / admin

10 Click 'Save' to save changed values.

11 To update the camera's firmware from the DW IP Finder™, click on the firmware tab, upload the firmware file and select the cameras to update. You can update multiple cameras at the same time.

Network Setup - Quick Start of Network Connection

Please follow the steps below to complete the initial setup of the network function.

- i** Do not power on the IP camera until instructed.
- i** Temporarily disable any proxy servers configured in Internet Explorer.
- i** If the IP camera is connected directly to a modem, power down and reset the modem. Leave the modem powered down until configurations are finalized with the IP camera and the IP camera has been correctly connected to the modem.

1. In order to communicate with the IP camera, access your PC/laptop for configuration. Keep a record of your PC's TCP/IP properties (IP address, subnet mask, gateway, DNS, etc.)

Current TCP/IP Settings	
IP Address	
Subnet Mask	
Default Gateway	
Primary DNS Server	
Secondary DNS Server (Optional)	

- i** If your PC obtains its IP address automatically, there is no need to record any information.

2. Change the IP address of the host PC to 192.168.1.11 and subnet mask to 255.255.255.0 (leave all other entries blank).
3. Connect the IP camera directly to your PC's Ethernet port via a crossover cable. (It does not matter what end is used for the PC).
4. Power on the IP camera using a power adapter.
5. After 1 minute, verify a flashing ACTIVE indicator and a flashing or solid LINK indicator. After the corresponding indicator lights are properly displayed, open Internet Explorer.
6. Type - <http://192.168.1.80> (the default IP of the IP camera) into your address bar.
7. Default ID/Password to access IP Camera are both the word: **admin**.
8. Locate the TCP/IP configuration under Setup> Network> TCP/IP.
9. Select STATIC under 'Network Type'. Select Dynamic only if you are connecting the IP camera directly to your cable/DSL/Broadband modem and your Internet Service Provider is supplying a dynamic address.

- i** If you have a network with other devices (such as PC/laptop, etc.) or a router, NEVER select Dynamic.

10. Configure the IP camera's TCP/IP settings as you normally do any other PCs on your network by providing a proper IP address, subnet mask, default gateway, and DNS server.

- i** If this is a stand-alone unit with a direct connection to cable/DSL/Broadband modem, input the addresses from your ISP. If you have received no IP address from your ISP, select Dynamic and choose the proper settings.

11. The IP Camera utilizes five TCP ports - Web Port, Video Port, Control Server Port, and Audio ports. A Web Port utilizes Internet Explorer, a Video Server port supports the streaming video, a Control Server Port transmits control commands to the camera and Audio Ports transmit and receive Audio data. If the IP camera is directly attached to a cable/DSL/Broadband modem or it has been assigned a static IP from your ISP, do not change the default port settings. If you are installing the IP camera on a network, you must define a Web Port other than 80 as some ISP block port 80. The other ports can remain unchanged.

12. If the IP camera is connected to a network utilizing a router, you must have Port Forwarding configured on your personal router to forward all ports to the IP address you have assigned the IP Camera. (See your Network Administrator for more information).

13. After configuring Port Forwarding on your router (if necessary), you may access your IP camera on your local network by opening Internet Explorer and typing the camera's IP address and Web Port.

- i** Example: <http://192.168.0.200:8888>

- i** If you leave your Web Port set to 80, you do not need to specify the port in the Address Bar to access to your IP Camera.

14. Access your IP Camera via the Internet :

If you use a static IP address assigned by your ISP

- 1) Open Internet Explorer.
- 2) Type the IP of the IP camera.
- 3) If you use a router, type the routers' static IP and the web port number of the IP Camera.

If you have a dynamic address provided by your ISP

- 1) Open Internet Explorer and visit the DDNS website.
- 2) Register the IP camera.
- 3) Reboot the IP camera.
- 4) Give the DDNS server up to 10 minutes to locate your IP camera's IP information.
- 5) Click the refresh button in Internet Explore.

Network Setup - Direct Connection to PC for Initial Setup

This section provides a guide on how to connect the IP camera to your PC/Laptop for initial setup.

Please follow the instructions in the order below. Do not supply power to the IP camera until instructed.

In order to access the IP camera's firmware you will need to connect the Video Server to a PC or Laptop directly via a network cable.

1. Before you begin, you must determine the current network/Internet (TCP/IP) settings on the PC or laptop. Write down your entries below for quick reference.

Current TCP/IP Settings	
IP Address	
Subnet Mask	
Default Gateway	
Primary DNS Server	
Secondary DNS Server (Option)	

- ❗ For information on how to determine your current settings, see Appendix A.
- ❗ If you are obtaining an IP Address automatically using DHCP Settings, there is no need to write down the information.

2. To make the IP camera communicate with your PC, change your PC's IP address and subnet mask.

- ❗ Change your PC's IP address to 192.168.1.11 and the subnet mask to 255.255.255.0
Leave all other entries (Default Gateway, DNS Servers, etc.) blank.
- ❗ For information on how to change your IP address and subnet mask, see Appendix B.

3. Attach the IP camera to your PC via a network cable. Plug-in either end of the network cable into the PC's network slot and the other end into your IP camera.
4. Power on the IP camera by plugging in a power supply.
5. Wait up to 1 minute after powering on the IP camera and verify that the ACTIVE indicator light is flashing, and the LINK indicator light is flickering or solid. If they are not, see FAQ.

6. You can now access the camera's viewer using Internet Explorer.

- ❗ Open Internet Explorer and type the IP address 192.168.1.80 (default IP of the IP camera) into the Address Bar of the web browser (as seen below). Press Enter.



- ❗ If a message box as below appears, choose 'Try Again'. The message will vary depending on the operating system.

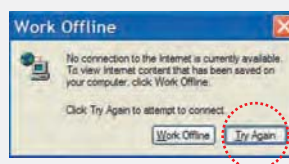

7. Once you connect to the camera successfully, the camera's login screen will appear.

- ❗ The 3 authorities are available : Administrator, Operator and Viewer. The authority setup is available in the camera's Setup menu.
 - Viewer : Only monitoring is allowed.
 - Operator : Most of the functions are allowed except 'Setup'.
 - Administrator : All functions are allowed.

8. The default ID and Password for the camera are both 'admin'
9. At any time if you are prompted to download ActiveX controls, Click 'Yes' as all contents are safe.

- ❗ You will have to click 'Yes' twice to two individual prompts. This allows your video to be displayed in Internet Explorer.

Network Setup - DDNS Registration

If you have DYNAMIC IP service from your Internet Service Provider (ISP), you will not be able to tell the current IP address of the IP camera. To solve this problem, you may register to our DDNS service.

Check if you are using dynamic addressing for the camera. If so, register your IP Video Server on our DDNS website before you configure, setup, or install the IP Camera.

Even though your IP is not dynamic, you can register your camera to the DDNS server. This allows you to remember a simple URL address instead of complicated series of numbers like <http://201.23.4.76:8078>.

For more details, contact our Support Center.

⊗ To use a public DDNS such as 'dyndns' or 'no-ip', refer to the detail information on how to use the service.
(Visit the web site : <http://www.dyndns.com> or <http://www.no-ip.com> for more information).

Network Setup - Guide to Network Environment

Please configure the IP camera at the installation site. Determine your network scenario in order to configure the IP camera with the proper TCP/IP settings. This tutorial will guide you through the process. Before configuring the IP camera, determine what settings need to be applied. Record those settings to be used to configure your IP camera for reference.

When configuring your IP camera, treat the IP camera as any other PC on your network. You will assign it several addresses and other TCP/IP properties to match your current network.

This step-by-step tutorial will teach what IP addresses and network configurations should be assigned based on the network scenario.

1. Before you begin, locate any information and settings received from your Internet Service Provider (ISP). You may need to refer to these IP addresses at a later time during the configuration.

Current TCP/IP Settings	
IP Address	
Subnet Mask	
Default Gateway	
Primary DNS Server	
Secondary DNS Server (Option)	

Static Dynamic

- i** If you were not given any IP addresses or the ISP was responsible for the setup and installation of your Internet connection, go to step 2.
- i** If you are not using a router on your network, your 'Current TCP/IP Settings' from the previous section and 'Assigned IP Addresses from My ISP' will be exactly the same.

2. You must determine whether the IP address is STATIC or DYNAMIC. At this moment, you are only concerned via the ISP. Did they provide you with a STATIC or DYNAMIC address? If you are unsure, contact your ISP.
3. Configure your IP camera's TCP/IP settings for network connectivity by selecting Setup from the camera's web viewer and selecting TCP/IP under the network settings.
4. If prompted for ID and Password, use 'admin' for both entries.
The default web port is 80. If port 80 is blocked by the ISP, a value between 1025 ~ 60000 should be used. If TCP port 80 is blocked, consult the ISP.
5. The following descriptions are several basic network scenarios. Determine which scenario describes your network. If your network does not match one of the scenarios below and you are unsure how to setup your IP camera, contact your network administrator and then call our Support Center.

Network Setup - Setup Case A, B

Case A: Dynamic IP + Personal Router [Most SOHO]

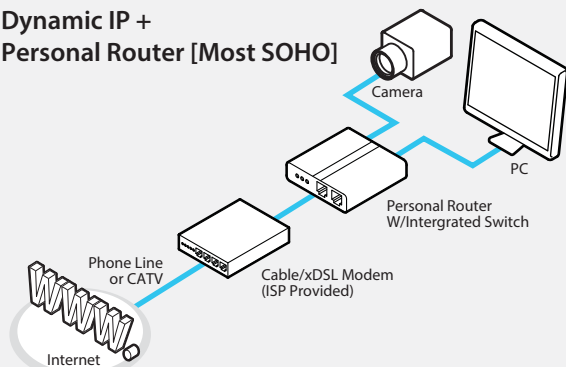

Case B: Static(Fixed) IP + Personal Router [Efficient]

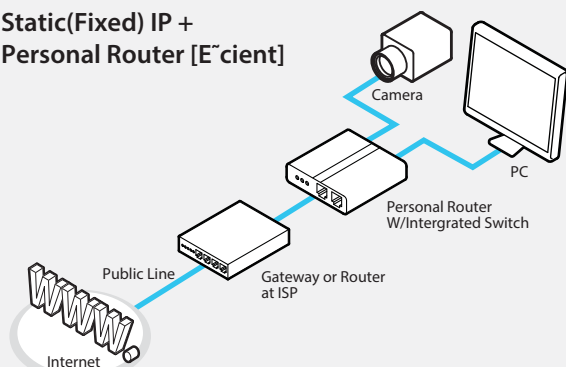

Configure your IP Camera's TCP/IP properties as follows :

1. **Network Type** : STATIC (even though you have Dynamic IP from your ISP, use STATIC on the IP Camera)
2. **Internet Address** : A private IP address such as 192.168.0.200 (Example)

- ❗ Assign an IP address to the IP Camera just as you do with PC.
- ❗ The IP address you assign must be unique to your network and match your network as well. For information on how to choose a unique IP and match your network, read the FAQ.
- ❗ The IP address you assign must be a private IP. For information on how to choose a private IP please, read the FAQ.

3. **Subnet Mask** : 255.255.255.0 (Example)

- ❗ Use the same subnet mask as the one you noted under 'Current TCP/IP Settings'.

4. **Default Gateway** : 192.168.0.1 (Example)

- ❗ This is the IP address of your router. (private or LAN side)
- ❗ Use the same Default Gateway you noted under 'Current TCP/IP Settings'.

5. **Preferred DNS Server** : Use the 1st DNS Server from 'Assigned IP Address from My ISP'.

- ❗ If you did not receive any IP addresses from your ISP, contact the ISP and acquire the IP address of their DNS server.

6. **DDNS Server** : Use the DDNS server.

- ❗ This is the same site you will register later to accommodate dynamic IP from your ISP.

7. **Web Port** : 8888

- ❗ Do not use the default port 80 as this number may be blocked by your ISP.
- ❗ You may select any number between 1025 ~ 60000.

Network Setup - Setup Case C, D

Case C: Static(Fixed) IP [Dedicated line directly to the IP Camera]

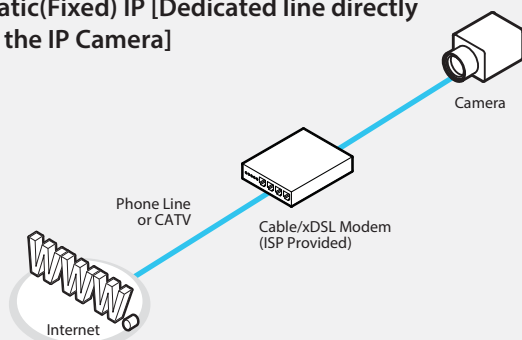

Configure your IP camera's TCP/IP properties:

1. **Network Type** : STATIC
2. **Internet Address** : A static IP address received from your ISP such as 24.107.88.125 (Example)

i Assign an IP address to the IP camera just as you do with PC.

3. **Subnet Mask** : Subnet mask assigned from your ISP such as 255.255.255.240 (Example)

4. **Default Gateway** : 24.107.88.113 (Example)

i Use the assigned default gateway from your ISP

5. **Preferred DNS Server** : Use the 1st DNS Server from 'Assigned IP Address from My ISP'

i Contact you ISP to acquire the IP address of their DNS server.

6. **DDNS Server** : Use the DDNS server

i The same site you will register later to utilize a DDNS service.

7. **Web Port** : 80

i You may select any number between 1025 ~ 60000.

Case D: Dynamic IP + DSL/Cable Modem [Connected directly to the IP Camera]

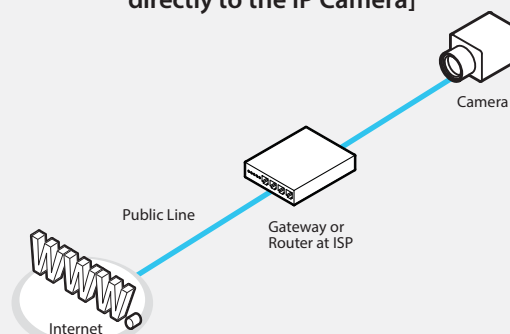

i To connect the IP camera directly to a modem, power down and reset the modem. Leave the modem powered down until configurations are finalized with the IP camera and the IP camera has been connected correctly to the modem. Then power on the modem, followed by the IP camera.

Configure your IP Camera's TCP/IP properties as follows :

1. **Network Type** : DYNAMIC
2. **DDNS Server** : Use the DDNS server

i The same site you will register later to accommodate dynamic IP from your ISP.

3. **Web Port** : 80

i You may select any number between 1025 ~ 60000.

Network Setup - Starting IP Camera

After forwarding correctly the Web Port, Video Port, Control Port and two Audio Ports through your router (if applicable), install the IP camera in a proper location.

1. Locate the serial number located on the label attached to the bottom of the IP camera, you will need this for DDNS registration.
2. Connect the IP camera to your router or cable/DSL modem (per your network scenario) via a Cat5/5e UTP Ethernet network cable.
3. Supply power to the IP camera (if not using a PoE switch)
4. After 1 minute, verify the IP camera indicators:
 - ACTIVE : Flashing
 - LINK : Flickering/Solid
5. After configuring Port Forwarding on your router (if necessary), access your IP camera on your local network by opening Internet Explorer and entering the IP address and Web Port assigned to the IP camera.

i Examples: <http://192.168.0.200:8888> or <http://24.106.88.123>

i If you left your Web Port set to 80, do not specify the port in the Address Bar to access the IP Camera.

6. Access your IP camera via the Internet :

If you use Case B, C

- 1) Open Internet Explorer.
- 2) Type the IP of the IP camera.

If you use Case A, D

- 1) Open Internet Explorer.
- 2) Visit the DDNS website.
- 3) Register the IP camera.
- 4) Give the DDNS server 10 minutes (MAX) to locate your IP Camera's IP information. You may reboot the server to send an immediate request to our DDNS server.
- 5) After your camera is connected, select your camera.

i The difference between B and C is that B needs to set the port forwarding.

i Since the type of DDNS differs from the service type, refer to the related service site.

Web Viewer Screen - Basic Screen

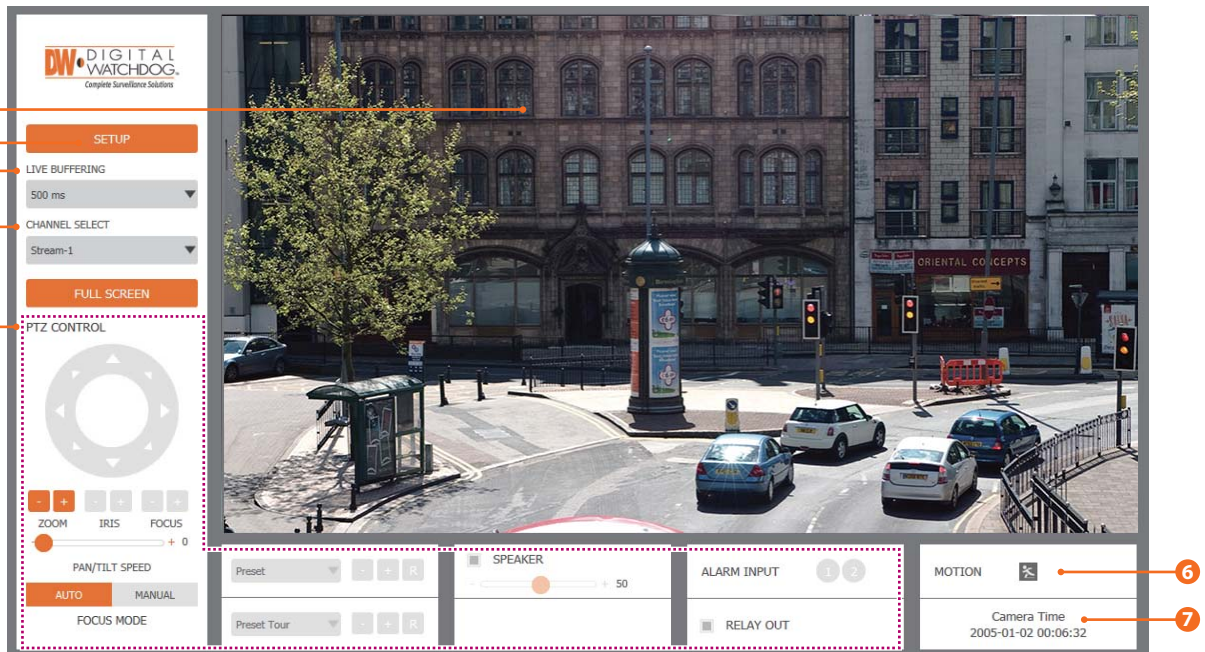

⊠ Web viewer is optimized with Internet Explorer10 or above version and Mozilla Firefox.

⊠ If VLC is not installed or VLC plug-in is not supported (such as in Chrome), Live buffering and Channel select menu will be changed to Live Viewer menu. In order to view video without the VLC plug-in, select HTML5(MJPEG) in the Live Viewer menu.

- 1 Live video display. This region displays live video stream from the camera.
- 2 Setup button. Click to open the Setup page to setup details such as Video, Network, Events, System and etc.
- 3 Live Buffering Setup. When there are network bandwidth limitations, and the image streaming is not optimal, the camera will store images during setup time and shot them on the live view screen. You can select the delay time from the available options in the drop-down menu.
- 4 Channel Select button. Select a stream to view from the camera. The camera supports three different streams.
 - ⊠ Refer the 'Setup > Basic > Video' to setup the Video Stream.

5 The following Menu options may not be available on all models.

PTZ Control

Does not support.

Preset

Does not support.

Speaker Control

Does not support.

Alarm Input

Does not support.

Relay Out

Does not support.

6 Motion

When motion detection is set on the camera, and motion occurs, the motion detection icon will light up.

7 Camera Time

Display current date and time as set in the camera's setup menu.

Setup - Setup Options Overview

The screenshot shows the 'VIDEO CONFIGURATION' page in the Digital Watchdog web interface. On the left is a navigation menu with the following items: VIDEO & AUDIO (expanded), VIDEO, OSD, ROI, PRIVACY MASK, > CAMERA, > NETWORK, > TRIGGER ACTION, > EVENTS, > RECORD, > SECURITY, and > SYSTEM. The main content area is titled 'VIDEO CONFIGURATION' and contains a table of streams, a 'Codec' configuration section, and an 'RTSP Session' section. The 'Streams' table has three rows: Stream 1 (H.264, channel1), Stream 2 (H.264, channel2), and Stream 3 (M-JPEG, channel3). The 'Codec' section includes dropdowns for Codec (H.264), Description (channel1), Resolution (1920x1080), Frame Rate (FPS) (30), Profile (High), Smart Bitrate Control (Off), Bitrate Mode (CBR), Target Bitrate (5120), Extension Option (Off), and Quality (5). The 'RTSP Session' section has a 'Time Out' field set to 0 and a checkbox for 'Default: Off, 30~120'. An 'APPLY' button is at the bottom right. The footer of the page reads '© Digital Watchdog. All Rights Reserved.'

Stream	Codec	Description
1	H.264	channel1
2	H.264	channel2
3	M-JPEG	channel3

Codec

Codec: H.264
Description: channel1
Resolution: 1920x1080
Frame Rate(FPS): 30
GOP: 30 [1 ~ 120]
Profile: High
Smart Bitrate Control: Off
Bitrate Mode: CBR
Target Bitrate: 5120 [100Kbps ~ 10Mbps]
Extension Option: Off
Quality: 5 [1 ~ 10]

RTSP Session

Time Out: 0 [Default: Off, 30~120]

APPLY

© Digital Watchdog. All Rights Reserved.

Refer to the breakdown below of all the setup options and menus. Click on any of the sub-menu options to jump to that section.

Video&Audio

[VIDEO, OSD, ROI, PRIVACY MASK]

Camera

[IMAGE ADJUSTMENT, EXPOSURE, DAY&NIGHT, BACKLIGHT, WHITE BALANCE, IMAGE, VIDEO]

Network

[STATUS, NETWORK SETTING, AUTO IP, ONVIF, UPNP, DDNS, FTP, SMTP]

Trigger Action

[ACTION RULES, IMAGE TRANSFER]

Events

[EVENT RULES, MOTION]

Record

[MANAGEMENT, RECORD LIST, STORAGE]

Security

[IP ADDRESS FILTER]

System

[INFORMATION, FIRMWARE UPDATE, DATE&TIME, DST , USER MANAGEMENT, LOG, FACTORY RESET, RESTART]

Setup - Video Configuration

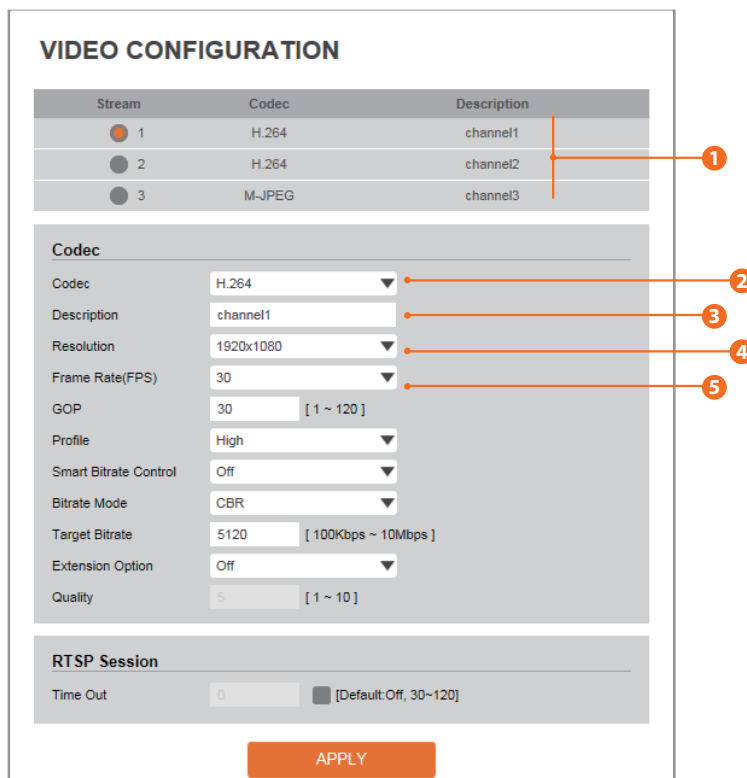

VIDEO CONFIGURATION

Stream	Codec	Description
1	H.264	channel1
2	H.264	channel2
3	M-JPEG	channel3

Codec

Codec: H.264
 Description: channel1
 Resolution: 1920x1080
 Frame Rate(FPS): 30
 GOP: 30 [1 ~ 120]
 Profile: High
 Smart Bitrate Control: Off
 Bitrate Mode: CBR
 Target Bitrate: 5120 [100Kbps ~ 10Mbps]
 Extension Option: Off
 Quality: 5 [1 ~ 10]

RTSP Session

Time Out: 0 [Default: Off, 30~120]

APPLY

1 Live Video Channel Setup

The camera supports three different streams/ channels. Each channel can be configured to variety settings with a combination of codecs and resolution. The camera performance has to be considered when setting multiple channels.

2 Codec

Choose the video codec. The subcategories will change automatically according to the selected codec. When MJPEG is selected, image transfer settings will become available for that channel/ stream.

3 Description

Enter a name or description for the selected channel. The maximum limit is 32 alphabet characters, including space. For the description, English Alphabets, numbers and special characters (- _ @ .) can be used.

4 Resolution

Select the video resolution.

⊠ Available resolution depend on the codec setup and the stream selected.

	NTSC	PAL
1080p/i	1920 x 1080	1920 x 1080
720p/i	1280 x 720	1280 x 720
SVGA	800 x 600	800 x 600
VGA	640 x 480	640 x 480
4CIF	704 x 576 704 x 480	704 x 576 704 x 480
CIF	352 x 288 352 x 240	352 x 288 352 x 240

<Resolution and Video Format>

5 Frame Rate

Select the maximum Frame Rate for each channel.

⊠ Available Frame Rate will differ according to the channel being set up.

Setup - Video Configuration

VIDEO CONFIGURATION

Stream	Codec	Description
1	H.264	channel1
2	H.264	channel2
3	M-JPEG	channel3

Codec

Codec:

Description:

Resolution:

Frame Rate(FPS):

GOP: [1 ~ 120]

Profile:

Smart Bitrate Control:

Bitrate Mode:

Target Bitrate: [100Kbps ~ 10Mbps]

Extension Option:

Quality: [1 ~ 10]

RTSP Session

Time Out: [Default: Off, 30~120]

APPLY

6 GOP(Group of Pictures) Size

Set up the number of frames (P-frame) to contain only changed information based on basic frame (I-frame). For video with lots of movement, the higher the GOP number, the video resolution will be low but 'File size' and 'Bit-rate' can be decreased.

⊠ GOP(Group of Pictures) Size is..

I-frame and P-frame can be created for MPEG4 and H.264 video compression. I-frame(=key-frame) means the whole image data for one specific frame of video. P-frame is an image which includes only the information that has changed compared to the I-frame. The GOP is made up of one I-frame and corresponding several P-frames. To improve video quality, set the number of P-frames low. To decrease image size, set the number of P-frames high.

7 Profile

The profile defines the subset of bit stream features in an H.264 stream, including color reproduction and additional video compression.

Baseline

A simple profile with a low compression ratio.
The Baseline profile supports I-frames and P-frames.

Main

An intermediate profile with a medium compression ratio.
The main profile supports I-frames, P-frames, and B-frames.

High

A complex profile with a high compression ratio.
The high profile supports I-frames, P-frames, and B-frames.

8 Smart Bitrate Control

Smart Low Bitrate (LBR) is an optimization of H.264 encoder in rate control to improve efficiency in scenes with static background. Also called Smart AVC (Advanced Video Coding), this function gives H.264 low bitrate streaming technology by significantly reducing network bandwidth requirements, lowering cloud storage costs and supporting the use of multiple cameras in a home environments.

OFF

Does not use the Smart Bitrate Control.

CVBR (Framerate priority)

This Mode is for cameras which do not want any frame drop, but still want to get lower bitrate. Performance may be limited when the Target bitrate is set to be very low, but motion area is big or the scene is very noisy.

CVBR (Quality priority)

When the Target bitrate is set to very low, and motion area is big, then LBR will try to drop frames, and make the final fps lower to save on bitrate, improving the output frames' quality.

CBR

Close to traditional security IPCAM, and it is not designed for LBR. This option is provided as an option in LBR library to help with image comparison.

Setup - Video Configuration

VIDEO CONFIGURATION

Stream	Codec	Description
<input checked="" type="radio"/> 1	H.264	channel1
<input type="radio"/> 2	H.264	channel2
<input type="radio"/> 3	M-JPEG	channel3

Codec

Codec:

Description:

Resolution:

Frame Rate(FPS):

GOP: [1 ~ 120]

Profile:

Smart Bitrate Control:

Bitrate Mode: 9

Target Bitrate: [100Kbps ~ 10Mbps] 10

Extension Option: 11

Quality: [1 ~ 10] 12

RTSP Session

Time Out: [Default: Off, 30~120] 13

14

9 Bitrate Mode

Select the bit rate control option for the video compression from CBR (Constant Bit Rate) or VBR (Variable Bit Rate).

CBR

To guarantee a constant bit rate, the quality of the video is controlled when using CBR. If CBR is selected, the video quality will change when network traffic changes.

VBR

To guarantee a constant video quality, the bit rate of the video stream is changed when using VBR. If VBR is selected, the video's frame rate will change when network traffic changes.

10 Target Bitrate

- ☒ If Bitrate Control is set to be CBR, you can set the Target Bitrate.

11 Extension Option

OFF

Extension option is disabled.

B-Frame On(BP) / B-Frame On(BBP)

Using B-Frames yields a better quality for the same data rate, or lower data rate for the same quality.

SVC-T On

Scalable video coding is a type of video encoding algorithm that can be applied to streaming to be transmitted over low bandwidth networks more effectively.

12 Quality

For VBR control mode, Target Quality of the video can be adjusted from 1 ~ 10.

13 Timeout

Set the RTSP timeout in accordance for each channel. RTSP timeout is disabled by default.

14 Click 'Apply' to save all changes.

Setup - OSD Configuration

ON SCREEN DISPLAY(OSD) CONFIGURATION

Date & Time Off On
Position X [0 ~ 100]
Position Y [0 ~ 100]

User Text Off On
Position X [0 ~ 100]
Position Y [0 ~ 100]
Text

APPLY

1 Date/Time

Display the camera's current date and time. If enabled, you can adjust the position of the date and time OSD display using an X and Y grid.

2 User Text

You can enter text to appear over the camera's video. If enabled, entered the desired text. The camera supports maximum 31 characters, including spacing. You can also adjust the position of the text using an X and Y grid.

3 Click 'Apply' to save all changes.

Setup - Region of Interest Configuration

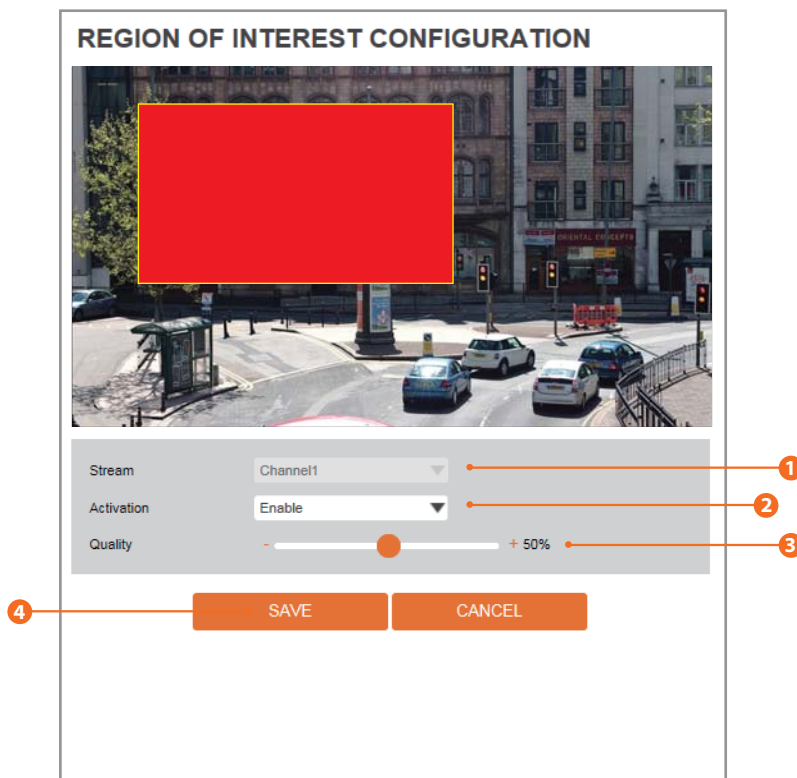

Region of interest (ROI) helps improve picture quality for a selected area. The ROI improves picture quality of when motion is detected without affecting bandwidth.

- 1 **Stream**
Select the Stream.
☒ ROI is currently supported only for Channel1.
- 2 **Activation**
Select 'Enable' from the drop-down to activate. Use the mouse to draw the region on the camera's preview screen.
- 3 **Quality**
Set the video quality of the set area. When motion is detected in the ROI, the video quality will remain according to the settings.
- 4 Click 'Apply' to save all changes.

Setup - Privacy Mask Configuration

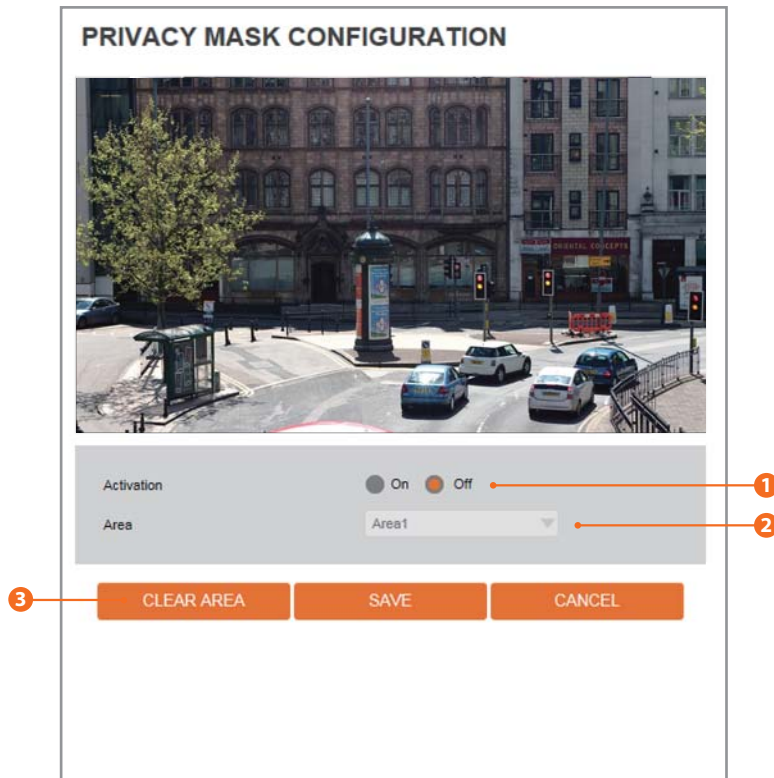

Use this function to mask areas that you want to hide on the screen and recorded video to protect privacy.

1 Activation

Select On to enable this feature.

2 Area

Select the Area1 ~ Area4 and Set the privacy area. To create a mask, click-and-drag your mouse across the camera's preview. You can adjust the mask's size by clicking on the edges of the mask. You can adjust the mask's position. by clicking on it and dragging it to the desired position.

3 Click 'Apply' to save all changes.

- ⊠ Click 'Cancel' to return to the previous setting.
- ⊠ Click 'Clear Area' to delete the selected Area1~Area4.

Setup - Camera Image Adjustment

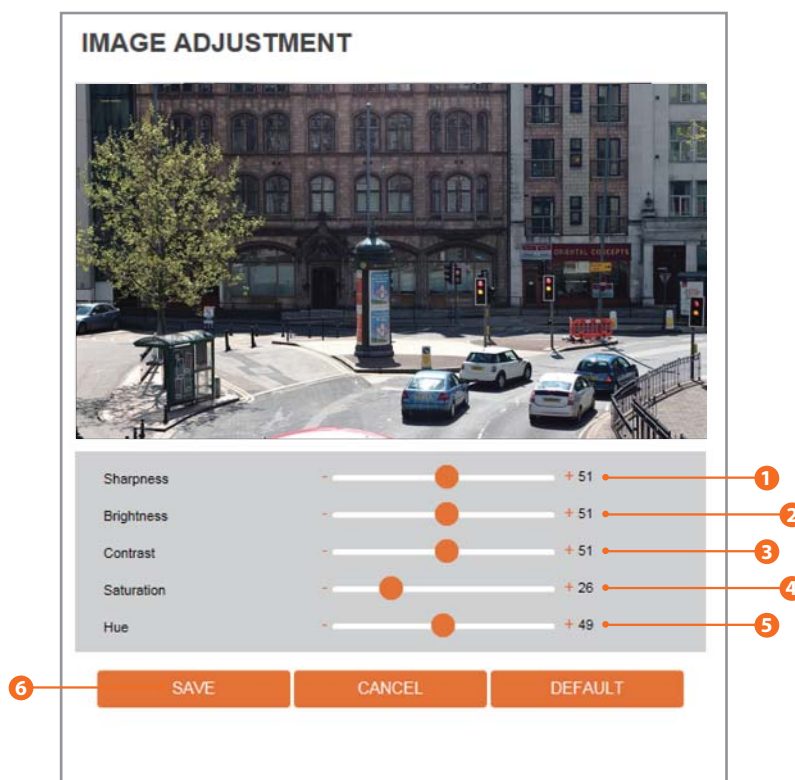

1 Sharpness

Sets the image sharpness. The higher the number, the sharper the image.

2 Brightness

Set the brightness of the camera's image. The higher the number, the brighter the camera's image will appear.

3 Contrast

Set the contrast of colors in the camera's image. The higher the number, the more contrast will appear between colors in the image.

4 Saturation

Set the saturation levels in the camera's image. The higher the number, the purer the colors in the image will appear.

5 Hue

Set the hue, or the color of the camera's image. The higher the number, the warmer the colors in the image will appear.

6 Click 'Apply' to save all changes.

- ☒ Click 'Cancel' to return to the previous setting.
- ☒ Click 'Default' to settings to the factory defaults.

Setup - Camera Exposure Settings

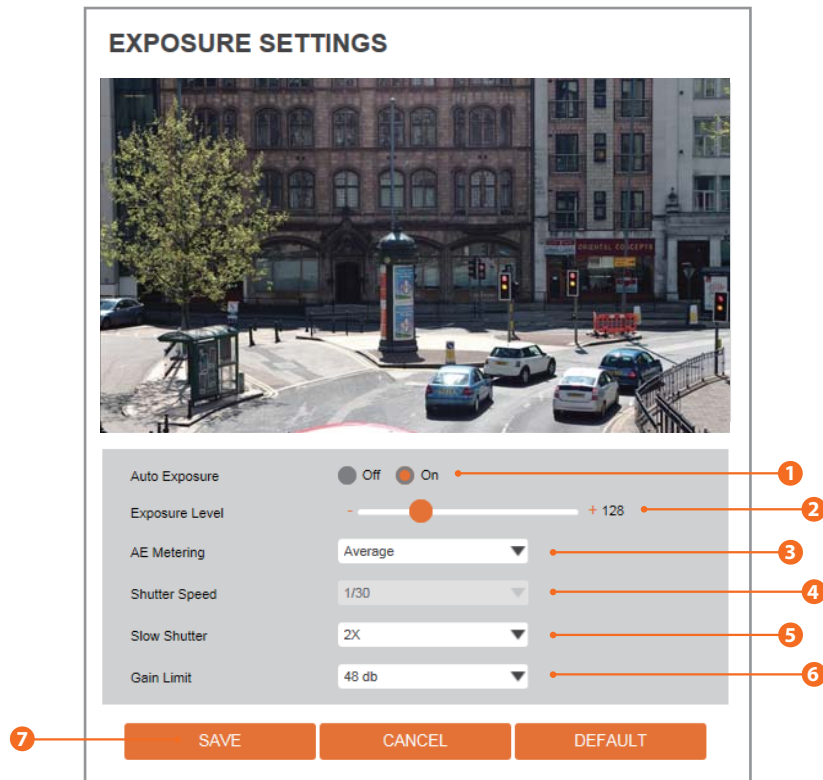

1 Auto Exposure

Automatic exposure(AE) automatically sets the aperture or shutter speed, based on the external lighting conditions for the camera.

2 Exposure Level

The higher the number, the brighter the camera's image will appear.

3 AE metering

AE metering mode refers to the way in which the camera determines the light exposure.

4 Shutter Speed

The faster the shutter speed is, moving object will be recorded without ghosting effect. However, the camera's image can appear dark if there is no sufficient lighting.

5 Slow Shutter Level

Slow shutter Level lets you adjust the amount of light striking the sensor, determining when the video sensor sends out its batch of data for processing.

6 Gain Limit

The smaller number, the darker the image will appear.

7 Click 'Apply' to save all changes.

✘ Click 'Cancel' to return to the previous setting.

✘ Click 'Default' to settings to the factory defaults.

Setup - Camera Day & Night Settings

DAY&NIGHT SETTINGS



Day & Night Auto Day Night Schedule 1

Color Level 2

B/W Level 3

Transition Time 4

Day -> Night Time : 5

Night -> Day Time :

6 SAVE
CANCEL
DEFAULT

1 Day & Night

Auto: The transition between color and B/W is set automatically depending on the lighting environment.

Day: The camera's image will remain in color by default, regardless of the lighting conditions. Sensitivity will be reduced in the dark light condition but a better color reproduction performance is obtained.

Night: The camera's image will remain in B/W by default, regardless of the lighting conditions. Sensitivity will be enhanced in the dark light condition.

2 Color Level

If Day/Night is set to AUTO, this will set the level of light at which the camera will switch from B/W to color mode. The value here should be lower than the one set for B/W Level.

3 B / W Level

If Day/Night is set to AUTO, this will set the level of light at which the camera will switch from color to B/W mode. The higher the number, the lower the light level has to be in order for the camera to switch to B/W mode.

4 Transition Time

If Day/Night is set to AUTO, adjust the rate at which the camera switches between color and B/W modes.

5 If Day/Night is set to schedule mode, Set the time of the day when the camera switches between day and night modes.

6 Click 'Apply' to save all changes.

⊠ Click 'Cancel' to return to the previous setting.

⊠ Click 'Default' to settings to the factory defaults.

Setup - Camera Backlight Settings

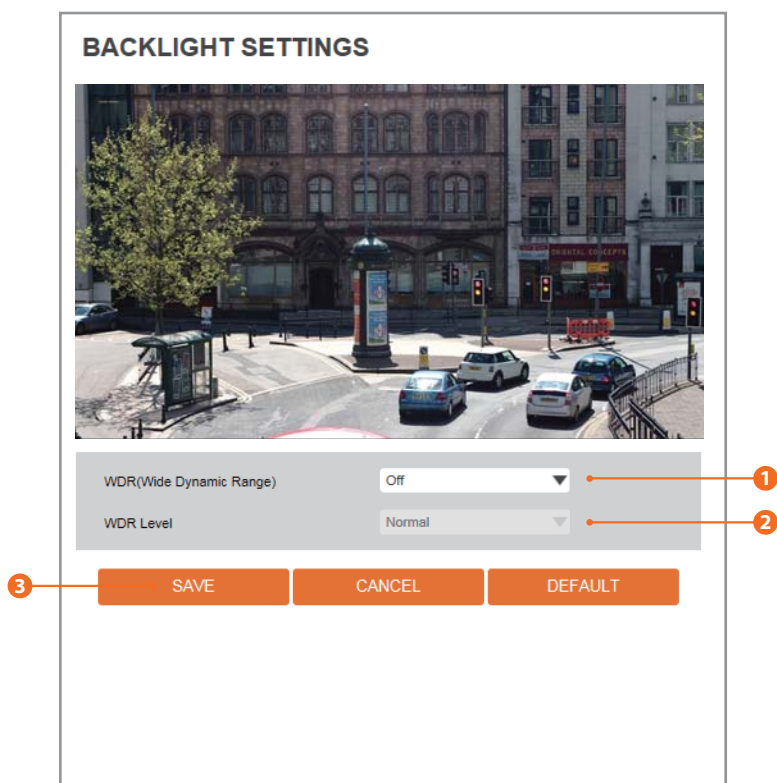

- 1 WDR (Wide Dynamic Range)**
the Wide Dynamic Range is used when there are extremely bright and extremely dark areas in the VoFof the camera.
- 2 WDR Level**
Select the WDR level depending on the difference in brightness between the darkest and lightest part of an image.
- 3** Click 'Save' to save all changes.
 - ☒ Click 'Cancel' to return to the previous setting.
 - ☒ Click 'Default' to settings to the factory defaults.

Setup - Camera White Balance

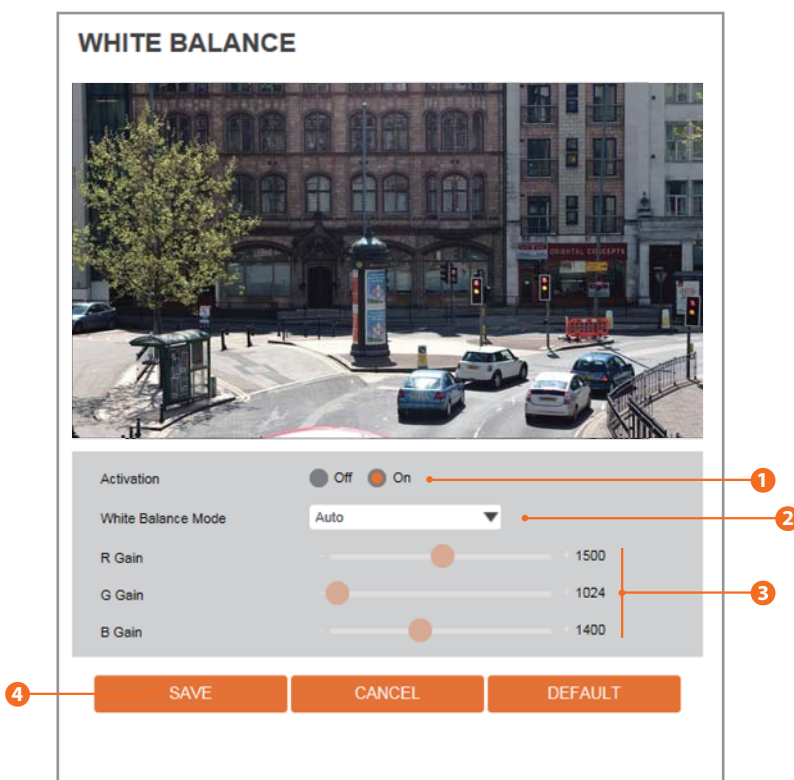

1 Activation

This gives the camera a reference to “true white.” White Balance is used to make colors appear the same in the Field of View (FoV) no matter what is the light temperature of the light source. To enable, check the ON button.

2 White Balance Mode

Select White Balance depending on the lighting conditions.

- Auto-Indoor: White balance is adjusted automatically for Indoor illumination. Adjust R-G/B-G gain.
- Auto-Outdoor: White balance is adjusted automatically for Sun light. Adjust R-G/B-G gain.
- Push: Click the ‘Push’ button continuously until screen image attain an ideal WB.
- Manual: The R/G/B gain level can be set up manually.
- Hold: Hold current status.

3 RGB Gain

The R/G/B gain can be set only when the White Balance Mode is set to Manual.

R Gain –The lower the number, the image will appear green. The higher the number, the image will appear red.

G Gain –The lower the number, the image will appear pink. The higher the number, the image will appear green.

B Gain –The lower the number, the image will appear yellow. The higher the number, the image will appear blue.

4 Click ‘Save’ to save all changes.

- ✘ Click ‘Cancel’ to return to the previous setting.
- ✘ Click ‘Default’ to settings to the factory defaults.

Setup - Camera Image Enhancement

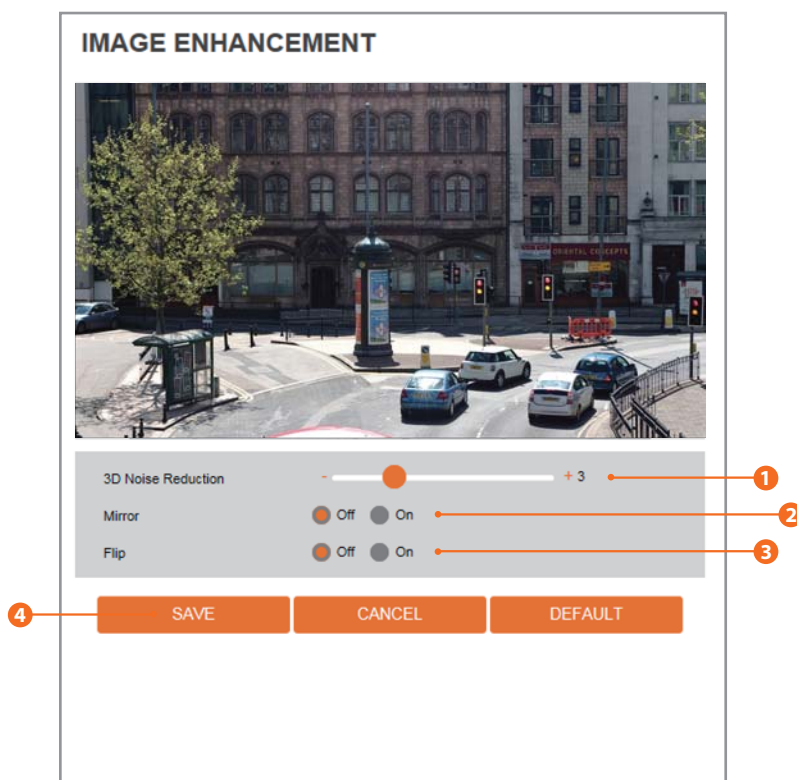

- 1 3D Noise Reduction**
3D-DNR reduces the noise on the screen in low light conditions and allows for clearer images, even at night. The higher the number, the more noise reduction will be applied to the image. However, high 3D DNR may cause a ghosting effect when motion is detected.
- 2 Mirror**
Chose to flip the camera's view horizontally.
- 3 Flip**
Choose to flip the camera's view vertically.
- 4** Click 'Save' to save all changes.
 - ⊠ Click 'Cancel' to return to the previous setting.
 - ⊠ Click 'Default' to settings to the factory defaults.

Setup - Video Enhancement

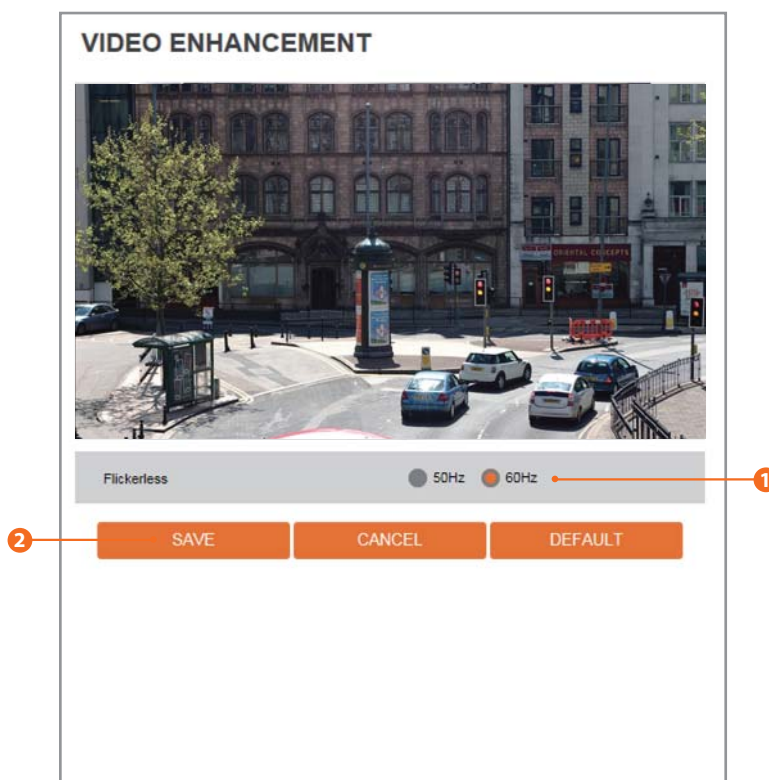

1 Flicker

When the camera's image appears to have flickering issues, change the frequency value to adjust the image.

2 Click 'Save' to save all changes.

- ✘ Click 'Cancel' to return to the previous setting.
- ✘ Click 'Default' to settings to the factory defaults.

Setup - Network Status

NETWORK STATUS	
MAC Address	64:76:57:CE:00:43
IP Address	192.168.1.33
Subnet Mask	255.255.0.0
Default Gateway	192.168.1.1
Preferred DNS Server	203.248.252.2
Alternate DNS Server	164.124.101.2
HTTP Port	80
RTSP Port	554

This menu will show you all the information of the camera's network settings. To change any of the values, use the additional setup menus under Network.

Setup - Network Settings

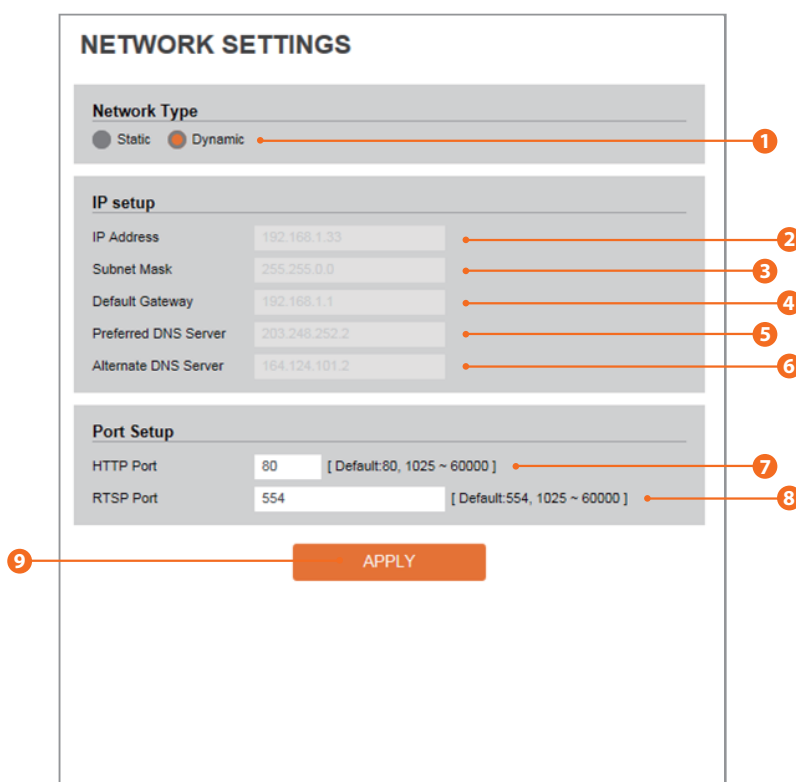

1 Network Type

Select the network type as DHCP or Static. If DHCP is selected, the camera will automatically get its network settings from the router. If static is selected, manually enter the camera's IP address, subnet mask, gateway and DNS information in the fields below:

2 IP Address

Define the IP address. The address is consisted of four numbers separated by dots and the range of each number is from 0 to 255.

3 Subnet Mask

Define the Subnet Mask. Format is same as the IP address. default is 255.255.255.0.

4 Default Gateway

Your router's external (public) IP address. It is used when accessing the camera from outside the network. The router will channel your data to the correct destination even if it is on a different subnet mask.

5 Preferred DNS Server

Enter Primary DNS and Secondary DNS. The Domain Name Server translates web addresses to IP addresses.

6 Alternate DNS Server

Define the Secondary DNS server IP address.

7 HTTP Port

The camera's default web port is 80. If needed, enter a different port number in the field between 1025 to 60000.

8 RTSP Port

The RTSP port's default value is 554. It can also be changed to any value between 1025 to 60000.

9 Click 'Apply' to save all changes.

⊗ If the network type is dynamic, the camera's IP address will change automatically in the cases below.

- When the camera power is on / off.
- After Firmware update, Default set and reboot.

In these cases, the camera will have to be rediscovered. In some cases, the camera will have to be reconnected in these cases.

Setup - Auto IP Settings

The screenshot shows the 'AUTO IP SETTINGS' interface. At the top, there is a 'General Setting' section with radio buttons for 'Off' and 'On'. Below this is a table with two rows: 'UNIQUE ID' with the value 'a832e4fb-8821-4c35-b232-66c415d674a5' and 'AUTO IP ADDRESS' with the value '169.254.189.3'. At the bottom center is an orange 'APPLY' button. Three numbered callouts are present: '1' points to the 'General Setting' section, '2' points to the table, and '3' points to the 'APPLY' button.

AUTO IP SETTINGS	
General Setting	
<input type="radio"/> Off <input checked="" type="radio"/> On	
UNIQUE ID	a832e4fb-8821-4c35-b232-66c415d674a5
AUTO IP ADDRESS	169.254.189.3
APPLY	

The Auto IP Settings menu, allows the camera to automatically obtain its IP address from the network. The network the camera is connecting to must have a DHCP server.

If a DHCP server is not available, the camera will use the IP address listed in the Auto IP Address section. All auto IP addresses follow the same pattern: 169.254.x.y. If you are using this option to assign the cameras IP addresses, make sure the network's IP settings are also set to 169.254.x.y, or the camera will not be able to communicate with the network properly.

Unlike DHCP, Auto IP does not require a router or a separate server to assign an IP address.

General Setting

- 1 You can enable or disable the camera's Auto IP Settings
- 2 **Auto IP Settings Information**
It displays the camera's unique id or Auto IP Configuration address.
- 3 Click 'Apply' to save all changes.

Setup - ONVIF Settings

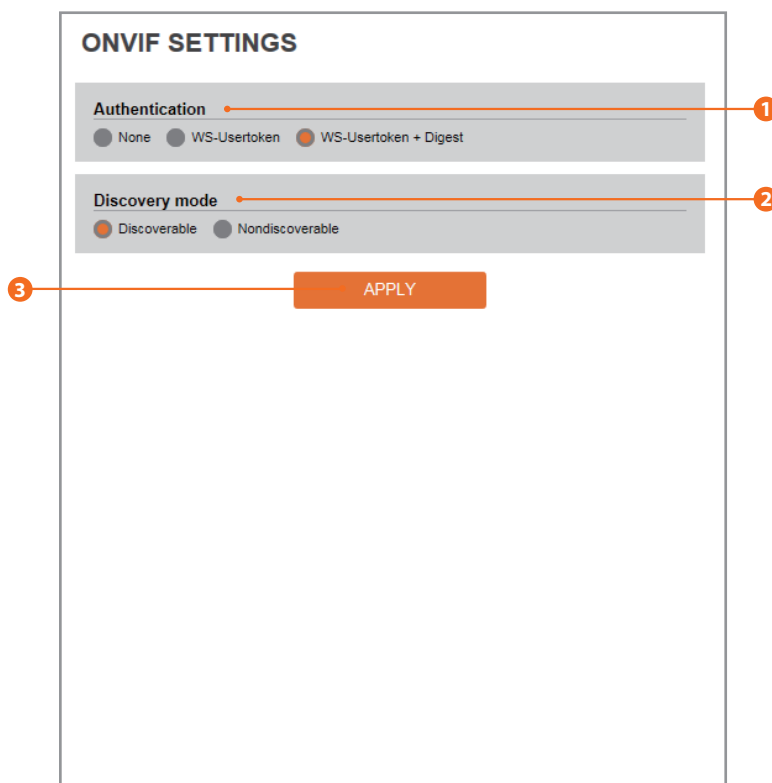

1 Authentication

None: Allows access to the camera without ONVIF authentication. **WS - Username token:** Allows access to the camera with WS-User Token of ONVIF authentication.

WS + Digest: Allows access to the camera with WS-User Token and Digest of ONVIF authentication.

2 Discovery Mode

Camera discovery via the ONVIF protocol function can be enable or disable.

3 Click 'Apply' to save all changes.

Setup - UPNP Settings

The screenshot shows the 'UPNP SETTINGS' interface. It is divided into two main sections: 'General Setting' and 'Device Information'. The 'General Setting' section has a radio button for 'Off' (selected) and 'On'. The 'Device Information' section has a text input field for 'FriendlyName' with the value 'IPV6 NSP2-ALAH2'. Below these sections is an orange 'APPLY' button. Three numbered callouts are present: '1' points to the 'General Setting' section, '2' points to the 'Device Information' section, and '3' points to the 'APPLY' button.

1 General Setting

UPNP function can be enable or disable. The UPnP function is disabled by default.

2 Friendly Name

Define the friendly name.

3 Click 'Apply' to save all changes.

Setup - DDNS Settings

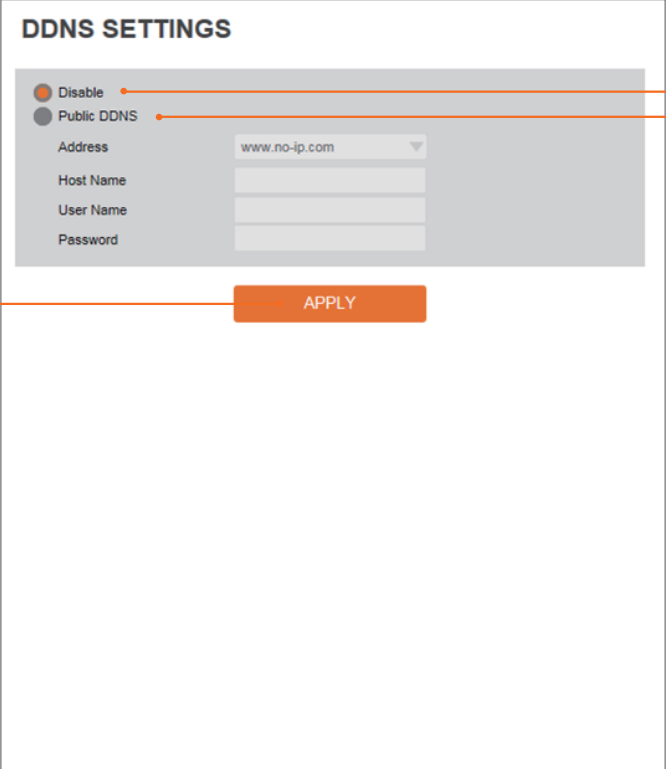

1 DDNS Disable

If you do not use a public IP address, DDNS provides you to connect on WAN. DDNS allows you to connect to the MEGApix camera with a URL address instead of an IP address. DDNS automatically redirects traffic to your IP address every time it changes. To enable, make sure "Public DDNS" is selected.

2 Public DDNS

To use public DDNS service, select a site from the available options. Enter Host Name. The Host name should be the same as the domain name. If applicable, enter a username and password for the DDNS name.

DDNS Provider	Site Address
DynDNS	www.dyndns.com
No-IP	www.no-ip.com

⚠ Some of these options may require additional registration at the DDNS website.

3 Click 'Apply' to save all changes.

Setup - FTP Settings

The screenshot shows the 'FTP SETTINGS' configuration page. It is divided into two main sections: 'General Setting' and 'Server information'. The 'General Setting' section has a radio button for 'Off' and a radio button for 'On', with a line pointing to the 'On' option labeled '1'. The 'Server information' section contains five input fields: 'FTP Server Address' (labeled '2'), 'FTP Upload Path' (containing '/', labeled '3'), 'FTP Port' (containing '21', labeled '4'), 'User ID' (labeled '5'), and 'Password' (labeled '6'). Below these fields is an orange 'APPLY' button, with a line pointing to it labeled '7'.

You can transfer or save images and videos from the camera to an FTP server for your records.

1 General Setting

To use the FTP function, make sure On is selected.°

2 FTP Server Address

Enter the FTP Server's IP Address.

3 FTP Upload Path

Define a path in the FTP server to store video from the camera. For the path name, English Alphabets, numbers and special characters (/ ~ ! @ \$ ^ () _ - { } [] ; ,) can be used.

4 FTP Port

Enter the FTP Server's Port information.

5 User ID

Enter the User ID to access the FTP Server.

6 Password

Enter the Password to access the FTP Server.

7 Click 'Apply' to save all changes.

Setup - SMTP Settings

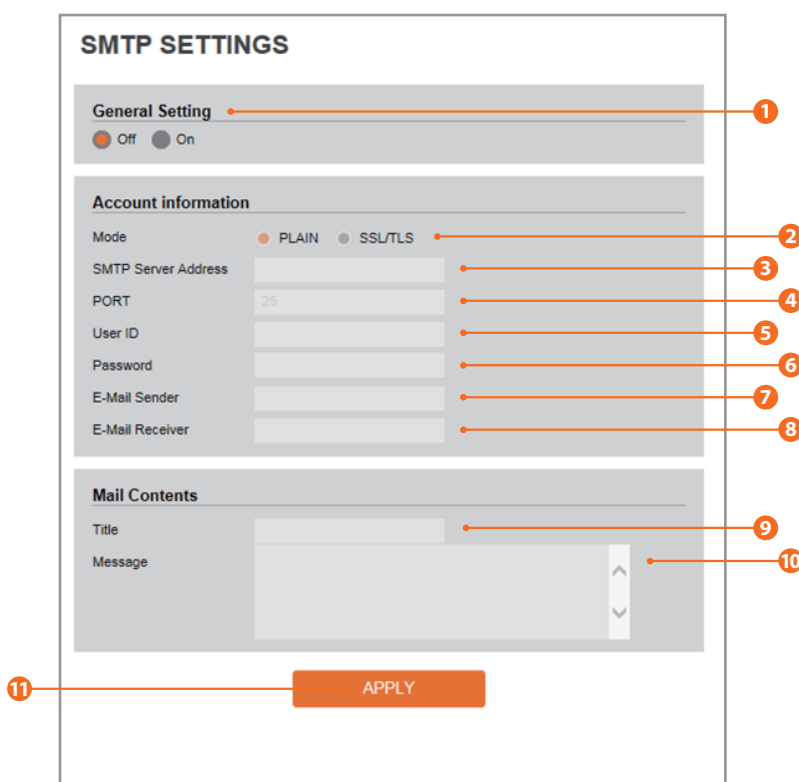

The screenshot shows the 'SMTP SETTINGS' configuration page. It is divided into three main sections: 'General Setting', 'Account information', and 'Mail Contents'. The 'General Setting' section has a radio button for 'On'. The 'Account information' section includes fields for 'Mode' (PLAIN or SSL/TLS), 'SMTP Server Address', 'PORT' (set to 25), 'User ID', 'Password', 'E-Mail Sender', and 'E-Mail Receiver'. The 'Mail Contents' section has fields for 'Title' and 'Message'. At the bottom is an 'APPLY' button. Numbered callouts (1-11) point to these specific elements.

The camera can send images to a relevant site by Email using SMTP protocol.

1 General Setting

To use the SMTP function, make sure On is selected.

2 Mode

Select the security mode from Plain or SSL / TLS.

3 SMTP Server Address

Enter the SMTP Server IP Address.

4 Port

Enter the Port used for Plain or SSL / TLS security mode.

5 User ID

Enter the User ID to access the SMTP Server.

6 Password

Enter the Password to access the SMTP Server.

E-Mail Sender

7 Enter an e-mail address representing the sender. All e-mails coming from the camera will use this address as the sending address.

8 E-Mail Receiver

Enter the e-mail address of E-Mail Receiver. This is the account that will receive the e-mails from the camera.

9 Title

Enter the title for all e-mails sent from the camera.

✘ The title of the Email is limited to 40 characters including spaces.

10 Message

Enter a default message. This message will appear in the body of the every e-mail sent from the camera. The message is limited to 40 characters including spaces.

11 Click 'Apply' to save all changes.

Setup - Action Rules Configuration

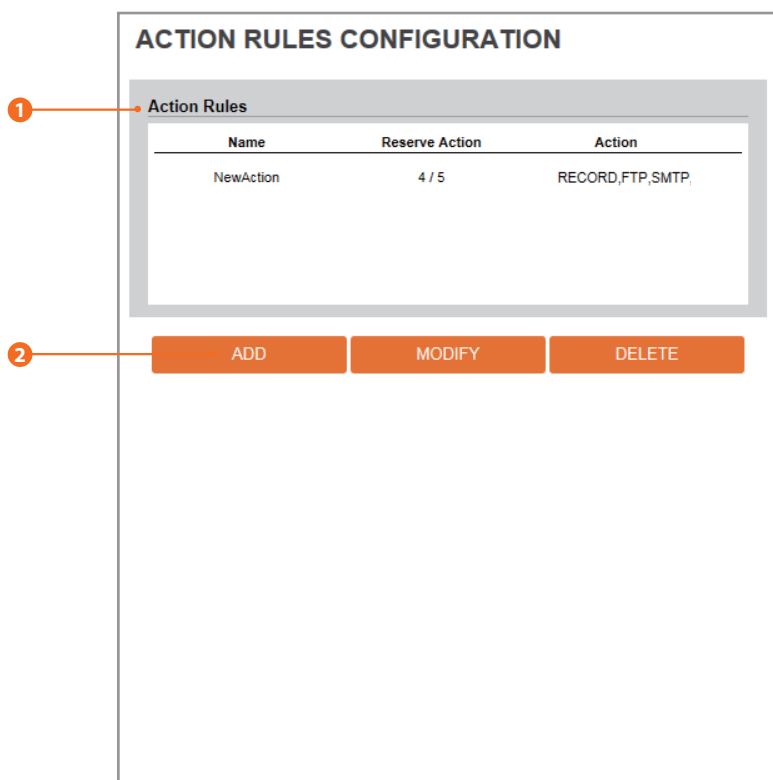

The camera supports the ability to establish action rules for different events the camera may experience. In order to use this feature:

1. You must setup different actions/ outcomes for the camera to follow. You can setup up to five (5) different actions for the camera. See the next page for more information.
2. Once you have the different actions the camera can take setup, you can select what events must occur in order for any of these actions to take place. See page 50 for more information.
3. Please note that in order to set the camera to record on motion, an action rule and event rule must be set prior to setting the recording schedule. See page 54 for more information.

1 Action rules List

The action rules list shows all currently configured actions and rules. You can modify existing action rules or create new ones.

2 Click 'Add' to add custom action rules. See next page for additional information.

- ✘ Click 'Modify' to modify a selected item from the action rules list.
- ✘ Click 'Delete' to delete a selected item from the action rules list.

Setup - Action Rules Add/Modify

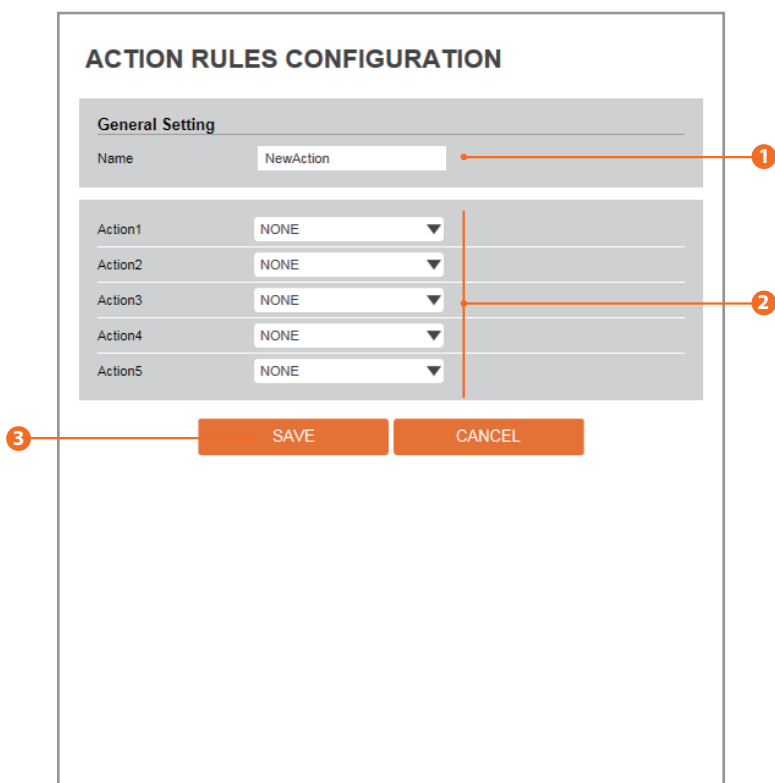

ACTION RULES CONFIGURATION

General Setting

Name

Action1

Action2

Action3

Action4

Action5

- 1 Name**
Enter the name associated with this action rule.
- 2 Action1 ~ Action5**
Select up to five different actions the camera can take once an event occurs. Select from the available drop-down options: SD Recording, FTP Image Transfer, SMTP Image Transfer, or Relay Control.
- 3** Click 'Save' to save all changes.

Setup - Image Transfer Configuration

IMAGE TRANSFER CONFIGURATION

Pre/Post Alarm Image

Number Of Image: 2 Image Per Seconds(s) [1 ~ 5]

Pre-Alarm Duration: 3 Second(s) [1 ~ 5]

Post-Alarm Duration: 3 Second(s) [1 ~ 30]

APPLY

When an event occurs (according to the Event Rules settings), the camera can send a jpeg. image to an FTP or SMTP destination.

The images are taken from the camera's 3rd stream.

To setup the image's destination, see page 50 for event rules setup.

1 Pre/Post Alarm Image

Image Transfer due to event is configured by setting Image transfer rate and Pre/Post alarm duration.

	Descriptions
Number of Image	Değne Number of image transferred per second.
Pre-alarm Duration	Define duration of image transfer before an event.
Post-alarm Duration	Define duration of image transfer after an event.

2 Click 'Apply' to save all changes.

Setup - Event Rules Configuration

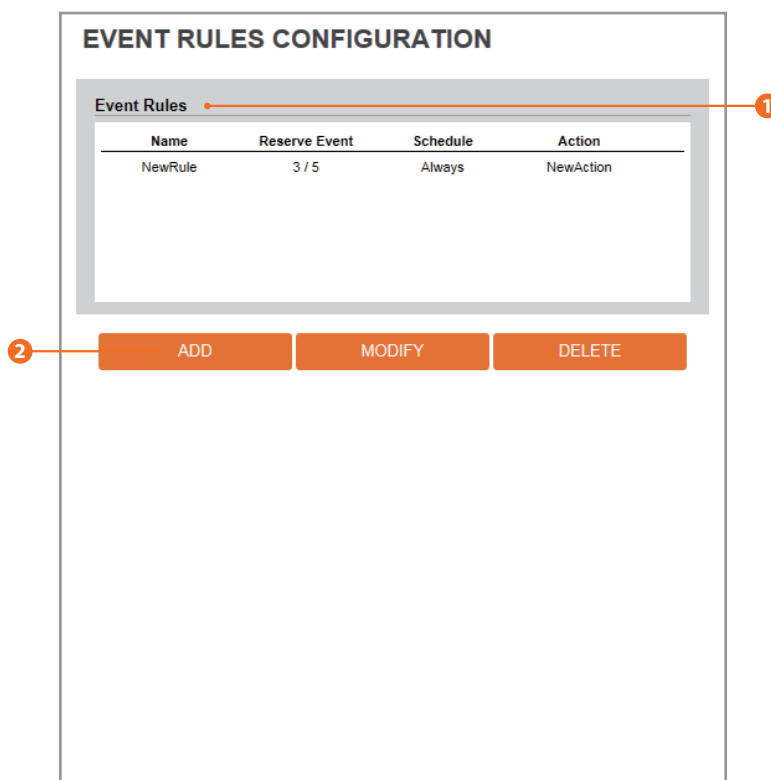

The camera supports the ability to establish event rules for different events the camera may experience. In order to use this feature:

1. You must setup different actions/ outcomes for the camera to follow. You can setup up to five (5) different actions for the camera. See page 47 for more information.
2. Once you have the different actions the camera can take setup, you can select what events must occur in order for any of these actions to take place. See the next page for more information. You can setup up to five (5) different event rules for the camera.
3. Please note that in order to set the camera to record on motion, an action rule and event rule must be set prior to setting the recording schedule. See page 54 for more information.

1 Event Rules List

Shows all custom Event Rules in the Event Rules list.

2 Click 'Add' to add custom event rules.

- ☒ Click 'Modify' to modify selected item from the event rules list.
- ☒ Click 'Delete' to delete selected item from the event rules list.

Setup - Event Rules Configuration

The screenshot shows the 'EVENT RULES CONFIGURATION' form. It is divided into three main sections: 'General', 'Event Condition', and 'Action'.
1. The 'General' section has a 'Name' field containing 'NewRule'.
2. The 'Event Condition' section has five 'Event' dropdown menus, all currently set to 'NONE'.
3. The 'Action' section has a 'Rules' dropdown menu set to 'NONE'.
4. At the bottom are two buttons: 'SAVE' and 'CANCEL'.

1 Name

Enter a name for the event rule.

2 Event Condition

Select which events to include in this rule. Select from Motion Detection, Sensor Alarm, or Schedule. If schedule is selected, the event rules will automatically activate at the set date and time. For example, you can set the rule to send an image transfer to the FTP server every hour. To enable this, make sure Schedule is set to manual.

⊗ You must select at least one event in order to activate the event rule.

3 Action

This drop-down menu will show all saved Action Rules (see page 47). You can select which of the action rules will take place once this event rule is triggered.

4 Click 'Save' to save all changes.

Setup - Motion Detection Configuration

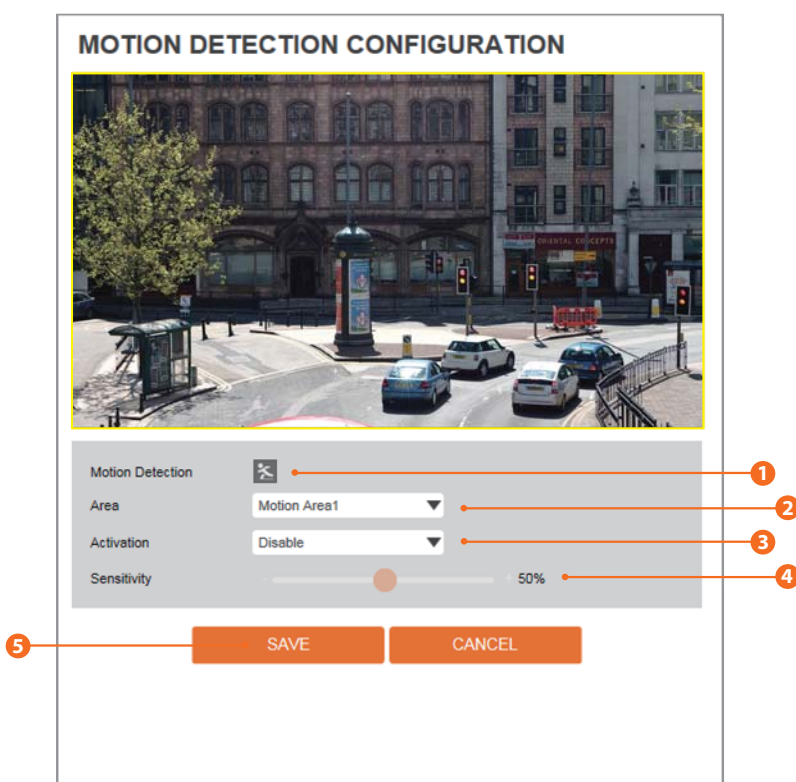

1 Motion Detection

Shows current Motion event status.

☒ Event Alert Icon (🔔) appears if 'Motion Detection' is activated.

2 Area

Set the motion detected area.

☒ You can set up to four (4) areas.

3 Activation

Enable or Disable motion detection for the area selected. If enabled, click-and-drag your mouse over the camera's preview to create the motion detection areas.

You can adjust the size of an area by moving the corners of the motion area.

You can adjust the position of the area by clicking and holding the area and moving it to the desired location.

4 Sensitivity

Adjust the sensitivity of motion detection for the selected area. If the sensitivity is set to high, it will detect very small motion in the camera's field of view. If the sensitivity is set to low, it will detect only large motion events in the camera's view.

5 Click 'Save' to save all changes.

Setup - Record Configuration

The screenshot shows a web interface titled "RECORD CONFIGURATION". It is divided into two main sections. The top section, "Record Global Setting", contains a dropdown menu for "Target Stream" currently set to "NONE". Below this is an orange "SAVE" button. The bottom section, "RECORDING LIST", contains a table with the following data:

Name	Enabled	File Type	Storage	Continuous
RECORD0	X	TS	SD Card	Off
RECORD1	X	TS	SD Card	Off

Below the table is an orange "MODIFY" button. Four numbered callouts (1-4) point to the "Target Stream" dropdown, the "SAVE" button, the "RECORDING LIST" table, and the "MODIFY" button respectively.

The camera supports up to two (2) different recording profiles. Both profiles will appear on the table, disabled by default. To set any of them up, select one, and click the 'Modify' button.

Please note that in order to set the camera to record on motion, an action rule and event rule must be set prior to setting the recording schedule. See page 47 for action rules setup and page 50 for event rule setup.

- 1 Target Stream**
Select the channel/ stream you want to record.
- 2** Click 'Save' to save all changes.
- 3 Recording List**
Displays information for the current recording settings. You can setup multiple recording settings for the camera based on difference scenarios and events.
- 4** Click 'Modify' to modify a selected item in the recording list. See the next page for additional information.

Setup - Record Configuration

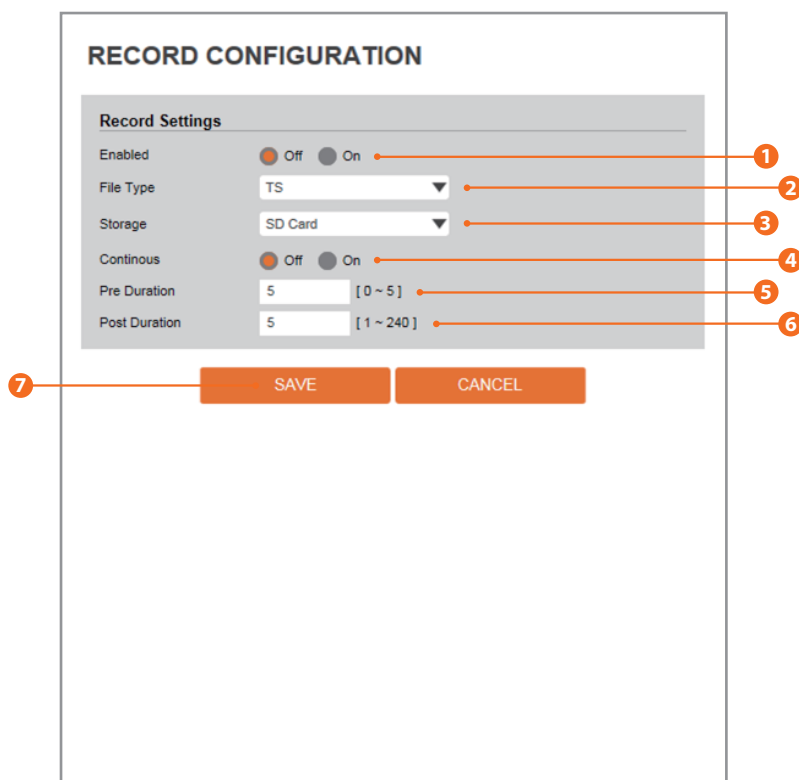

1 Enabled

Enable or disable recording for the selected setting.

2 File Type

Select the recording file type from the available options in the drop-down list. Currently, the camera supports only TS format.

3 Storage

Select the storage type. Currently, the camera supports only SD card recording.

4 Continuous

If continuous mode is enabled, the camera will start recording to the designated destination once the settings are saved. If continuous is set to OFF, the camera will record according to action rules and event rules set previously. See page 47 for action rules setup and page 50 for event rule setup.

For example: To set the camera to record on motion:

1. Go to the Action Rule and create a new Action Rule for SD recording.
2. Go to Event Rule and create a new rule.
3. Select SD recording from the Event Rules drop-down list.
4. Select Motion from the Event Condition drop-down list.
5. Under the Recording Configuration page, set continuous to OFF and adjust the pre- and post- recording durations.

Motion detection must be setup for the camera to record motion events. See page 53.

5 Pre Duration

Set the duration of recording before an event occurs.

6 Post Duration

Set the duration of recording once an event ended.

7 Click 'Save' to save all changes.

Setup - Recording List

The screenshot shows the 'RECORDING LIST' interface. At the top, there is a 'Filter' section with checkboxes for Date, Time, Event, Storage, and Sort, each followed by a dropdown menu. Below the filters are 'REFRESH' and 'FILTER' buttons. The main area contains an 'Event' table with columns for Day, Time, Duration, and Event. Below the table are 'PLAY', 'REMOVE', and 'DOWNLOAD' buttons. Numbered callouts 1-4 point to the Filter section, the REFRESH button, the Event table, and the PLAY button respectively.

Day	Time	Duration	Event
2016/05/03	15:31:17	03:01	On Continuous
2016/05/03	15:26:16	05:00	On Continuous
2016/05/03	15:21:15	05:00	On Continuous
2016/05/03	15:16:14	05:00	On Continuous
2016/05/03	15:16:14	00:03	On Continuous
2016/05/03	15:11:13	05:00	On Continuous

The recording list shows all available recorded data from the camera. You can filter the results, play specific video or download files for your record.

1 Filter

You can filter the camera's recorded files by date /time, event, sort or storage format. Even if the camera is set to continuous recording, the files appearing in the search results are limited to five (5) minutes long.

2 Click the 'Refresh' button to refresh the records list.

☒ Click 'Filter' to view the filtered recorded video.

3 Recording List

The table will display all recorded video from the camera that applies to the selected filters.

4 Click 'Play' to view the selected item in list of recorded video.

☒ Click 'Remove' to delete the selected item from the recorded video list.

☒ Click 'Download' to download the selected item.

Setup - Recording Video

RECORDING VIDEO



1

Recording Video

Token	00010043572845b5
Status	Completed
Start Time	2016/05/03 15:31:17
End Time	2016/05/03 15:34:18
Recording Time	03:01

2

REPLAY

BACK

3

Once you select a recorded video to play, the video will appear in a player as shown above.

- 1 Recording Video Viewer**
Play the recorded video.
- 2 Recording Video Information**
Displays information regarding the recorded video currently being viewed.
- 3 Click 'Replay' to view the recorded video again.**
 - ☒ Click 'Back' to return to the previous menu.

Setup - Storage Configuration

STORAGE CONFIGURATION			
Storage List			
Name	Size	Used(%)	Available
sdcard0	14.8G	28%	10.7G

The camera supports local SD card for recording and backup. See page 13 for installation and additional hardware information.

Display the SD card information mounted from device.

☒ To adjust the settings for the SD card, double-click on the card's name in the Storage List.

Setup - Storage Configuration

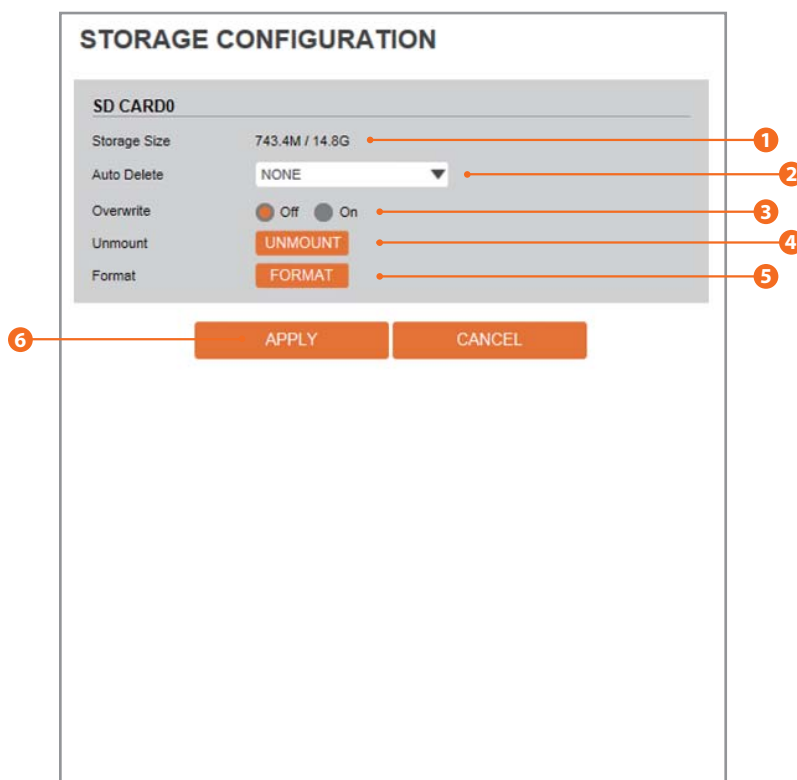

1 Storage Size

Total capacity of the SD card and available space are displayed.

2 Auto Delete

Select the period for Auto deleting data from the SD card. The image data stored before period will be deleted automatically. Once the time limit is reached, any stored images that pass the time limit will be deleted, regardless of the SD card's storage availability.

3 Overwrite

If enabled, and there is less than 8MB of free space on the SD card, new images from the camera will start to overwrite the oldest data available.

If overwrite is disabled, and there is less than 8MB of free space on the SD card, recording will stop.

4 Unmount

Remove the SD card safely from the device.

5 Format

Delete the all contents stored in SD card.

6 Click 'Apply' to save all changes.

Setup - IP Address Filter Configuration

The screenshot shows the 'IP ADDRESS FILTER CONFIGURATION' interface. It is divided into several sections:

- General:** Contains 'IP Address Filter' with radio buttons for 'Enable' and 'Disable' (1), and 'IP Filter Type' with a dropdown menu set to 'Allow' (2).
- APPLY:** An orange button (3) to save the configuration.
- Filtered IP Address:** A section header (4) above a scrollable list box for displaying filtered IP addresses.
- IP Address:** An input field (5) with a placeholder '[Invalid]' for adding new IP addresses.
- Buttons:** Three orange buttons at the bottom: 'ADD' (6), 'REMOVE', and 'REMOVE ALL'.

- 1 **IP Address Filter**
IP filter function can be enable or disable.
- 2 **IP Filter Type**
Select the recording IP filter type.
- 3 Click 'Apply' to make above setting effective.
- 4 **Filter IP Address**
Display the filtered IP address.
- 5 **IP Address**
Define the IP address you want to apply the IP filter.
- 6 Click 'Add' to add the ip address to the list.
 - ✘ Click 'Remove' to remove the ip address selected in the list.
 - ✘ Click 'Remove All' to remove all ip in the list.

Setup - System Information

SYSTEM INFORMATION

Model Name	N5F4-ALAH2
Manufacturer	IPNC
Max Resolution	1080p
Max Framerate	30 fps
Photo Resistor(CDS)	SUPPORT
Alarm In	NOT SUPPORT
Relay out	NOT SUPPORT
Audio	NOT SUPPORT
Optical Zoom	X4
Digital Zoom	NOT SUPPORT
PTZ	NOT SUPPORT

System Capability information.

Setup - Firmware Update

FIRMWARE UPDATE

Notice

1. Do not power off during update. It may cause fatal system damage.
2. If Explorer was closed abnormally or a user closed accidentally while uploading firmware file, please try again after 30 seconds.
3. Please do not select other menus while updating firmware file.

Version Information

System	2016.4.22_0.9.3
Camera	0.1

Web update

Firmware File

FTP user information

FTP Server Address	<input type="text" value="ftp.dwcc.tv"/>
FTP Port	<input type="text" value="21"/>
User ID	<input type="text" value="dwmpix"/>
Password	<input type="password" value="*****"/>
FTP Upload Path	<input type="text" value="/"/>

The screenshot shows a web interface for firmware updates. It includes a 'Notice' section with three warning points. Below that is a 'Version Information' section showing system and camera versions. The 'Web update' section has a 'Select File' button. A 'START F/W UPDATE' button is centered below. The 'FTP user information' section contains input fields for server address, port, user ID, password, and upload path. At the bottom are 'SAVE', 'CANCEL', and 'CHECK' buttons. Three numbered callouts (1, 2, 3) point to the 'Version Information' section, the 'Select File' button, and the 'START F/W UPDATE' button respectively.

1 Version Information

It shows the camera's current Firmware Version.

2 Web Update

Select the Firmware file to upload from your computer's directory by clicking [Select file] button.

3 Start F/W Update

Click to start the update. The Progress Bar will show the update process.

⊠ Warning:

1. Do not turn off the camera's power supply during the Firmware update. The system can freeze or become unstable. Once the update is complete, the system will reboot automatically.

Setup - Firmware Update

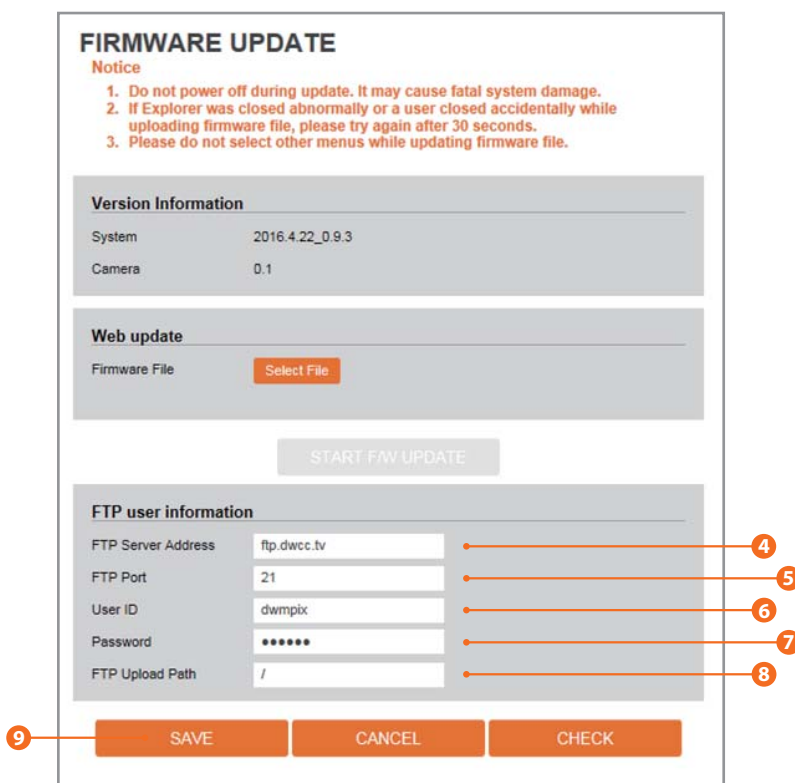

FIRMWARE UPDATE

Notice

1. Do not power off during update. It may cause fatal system damage.
2. If Explorer was closed abnormally or a user closed accidentally while uploading firmware file, please try again after 30 seconds.
3. Please do not select other menus while updating firmware file.

Version Information

System	2016.4.22_0.9.3
Camera	0.1

Web update

Firmware File

FTP user information

FTP Server Address	ftp.dwcc.tv	4
FTP Port	21	5
User ID	dwmpix	6
Password	*****	7
FTP Upload Path	/	8

9

4 FTP Server Address

You can update the camera using Digital Watchdog's FTP Server. The IP Address, username and password will be filled out automatically. Default server IP address: ftp.dwcc.tv

5 FTP Port

Shows the FTP Server's Port. This information will be available automatically. Default port is: 21

6 User ID

Shows the User ID to access to the FTP Server. This information will be available automatically. Default user ID: dwmpix.

7 Password

Shows Password to access to the FTP Server. This information will be available automatically. Default Password:

8 FTP Upload Path

Define a path in FTP server to store video. For the path name, English Alphabets, numbers and special characters (/ ~ ! @ \$ ^ () _ - { } [] ; ,) can be used.

9 Click 'Save' to save all changes.

SAVE	Save the FTP information.
CANCEL	Click 'Cancel' to return to the previous setting.
CHECK	Check for new F/W. If an update is available, an 'F/W Update' button will appear. Click on it to start the update.

Setup - Date & Time Settings

The screenshot shows the 'DATE&TIME SETTINGS' interface. It is divided into three main sections: 'TimeZone Setup', 'Current Date & Time', and 'New Camera Date & Time'.
1. 'TimeZone Setup' contains a dropdown menu for 'TimeZone' set to '(GMT 00) Greenwich Mean Time, Lisbon, London,' and an 'APPLY' button below it.
2. 'Current Date & Time' shows the current date as '2005-01-01' and time as '00:02:38'.
3. 'New Camera Date & Time' has three radio button options: 'Synchronize with my computer' (selected), 'Setup manually', and 'Synchronize with time server Time Zone'.
4. Under 'Synchronize with my computer', the date is '2016-04-22' and time is '16:26:59'.
5. Under 'Synchronize with time server Time Zone', the 'TimeZone' dropdown is set to 'time-a.nist.gov'.
6. An 'APPLY' button is located at the bottom of the 'New Camera Date & Time' section.

1 TimeZone Setup

Select the appropriate time zone for the camera and click 'Apply' before setting up the rest of the date and time settings.

⚠ Prior to setting below 'New Camera Date & Time', set the correct time zone.

2 Current Date & Time

Shows the current date and time setting in the Camera.

3 Synchronize with my computer

Set the date and time using the settings from the PC currently connected to the camera.

4

Setup manually

Set the date and time manually.

5 Synchronize with a time sever's Time Zone

Set the date and time of the camera by syncing with a time server. Select a server from the available drop-down options. Date and time will be updated automatically every hour.

6 Click 'Apply' to save all changes.

Setup - DST Settings

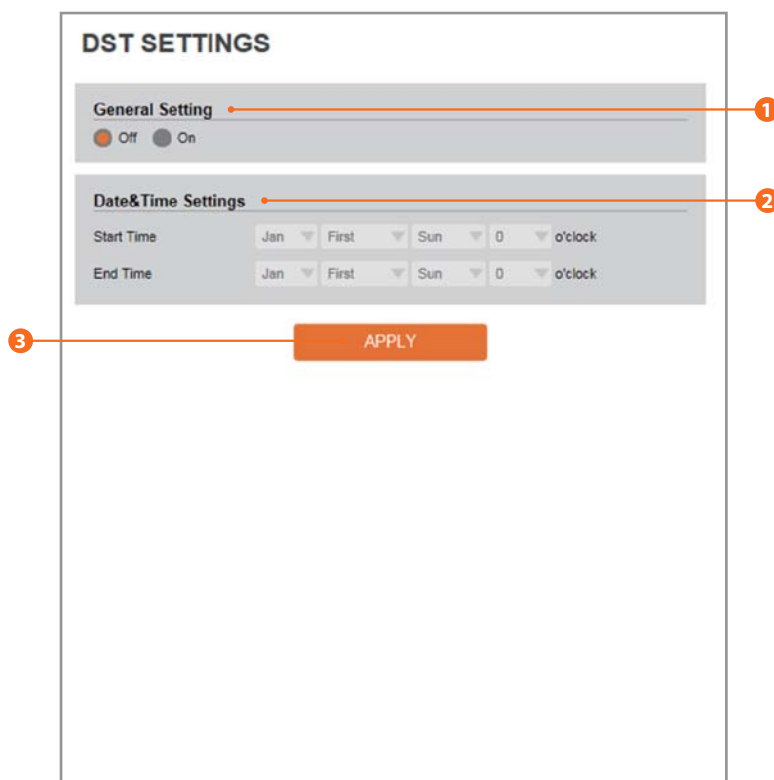

The screenshot shows the 'DST SETTINGS' interface. It is divided into two main sections: 'General Setting' and 'Date&Time Settings'. The 'General Setting' section has two radio buttons: 'Off' (selected) and 'On'. The 'Date&Time Settings' section has two rows of dropdown menus. The first row is for 'Start Time' and the second row is for 'End Time'. Both rows have dropdowns for month (Jan), day (First), day of the week (Sun), and hour (0), followed by 'o'clock'. Below these settings is an orange 'APPLY' button. Three numbered callouts are present: '1' points to the 'General Setting' section, '2' points to the 'Date&Time Settings' section, and '3' points to the 'APPLY' button.

Daylight Saving Time (DST) is the practice of setting the clocks forward one hour from standard time during the summer months, and back again in the fall.

- 1 General Setting**
Select to enable or disable DST.
- 2 Date&Time Settings**
Set the Start time and end time for the DST.
- 3** Click 'Apply' to save all changes.

Setup - User Management

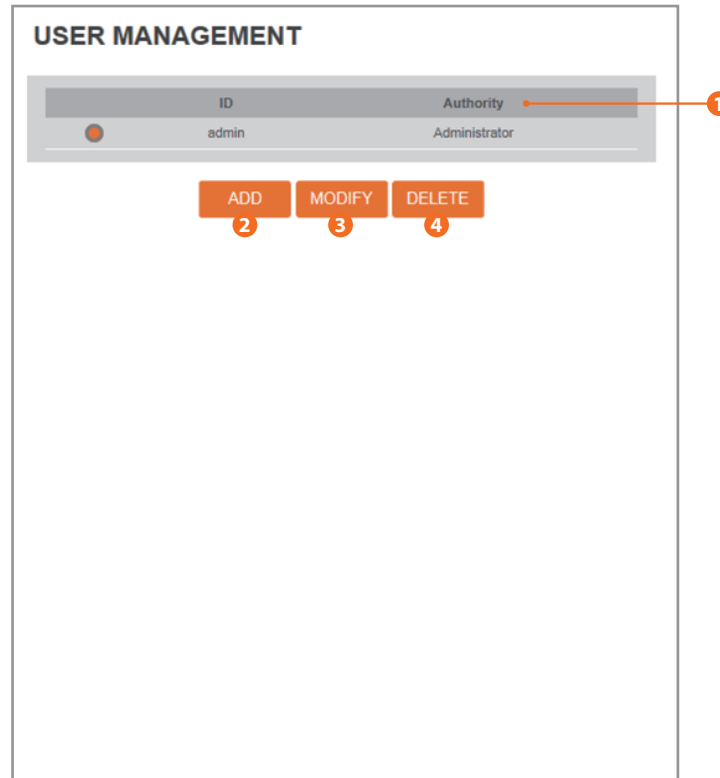

1 Users
List all current user accounts for the camera. The camera supports up to five (5) users.

2 Add
Register a new user.

ID	Enter a new user ID except Admin.
Password	Enter the user's Password.
Verify	Enter the user Password again for verification.
User Authority	Select Operator or Viewer. Viewer : Only monitoring is allowed. Operator : Most of the camera's functions are allowed except access to the 'Setup'. Administrator : All functions are allowed.

⚠ The ID and Password are limited to 10 characters.

Click 'Apply' to save all changes.

3 Modify
Modify the information of an existing user account. For the admin account, only the Password can be modified.

4 Delete
Delete a selected user account. Admin account cannot be deleted.

Setup - System Log

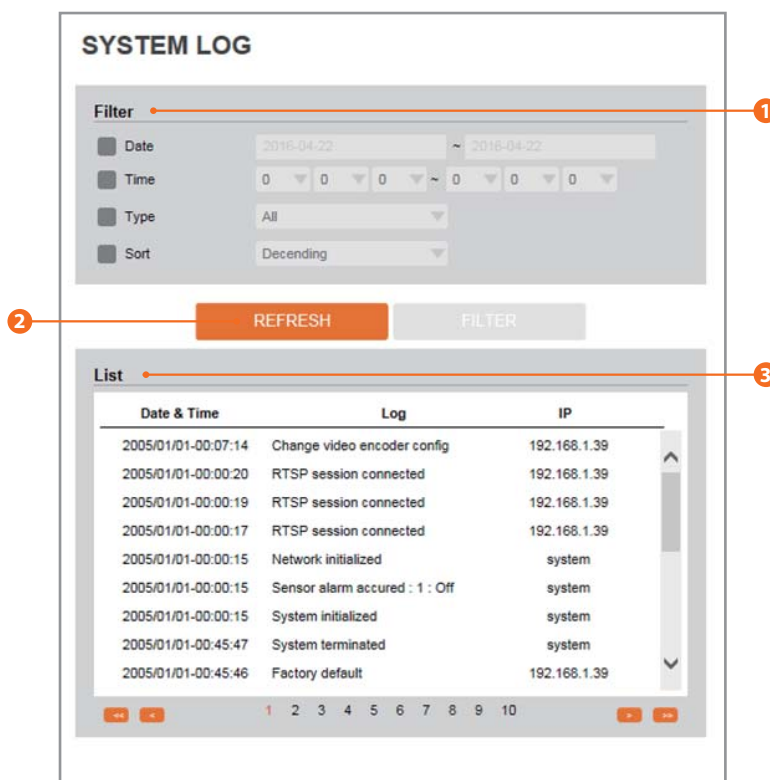

The system log shows all log activity for the camera. You can filter the results by date, time, type and sort.

- 1 **Filter**
Select a date, sort or type of log to filter the log.
- 2 Click the 'Refresh' button to apply update the log's results.
✳ Click 'Filter' to view the yltered log.
- 3 **System Log List**
All log entries that apply to the set filters will be shown.

Setup - Factory Reset



- 1 Reset to the factory default will return all setup configurations to their factory default values.

All

Reset all Settings to their factory defaults.

Except Network Settings

Reset all Settings to their factory defaults. except network related settings.

Only camera settings

Reset settings only related to the camera's image and video settings.

- 2 Click 'Apply' to save all changes.

Setup - Restart

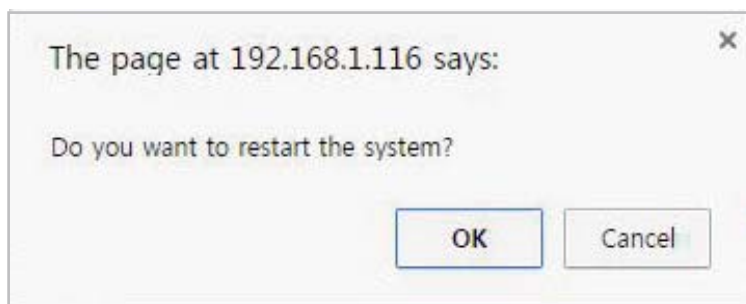

If you click the 'RESTART' menu, a message box will be shown to confirm. Click the 'OK' button to restart.

Appendix

A : Current TCP/IP Settings

i If your IP settings are obtained automatically, you could use the MS-DOS prompt (or Command Prompt) to determine your IP address. For information on how to do this, please read the FAQ.

1. Windows 98 / ME Users

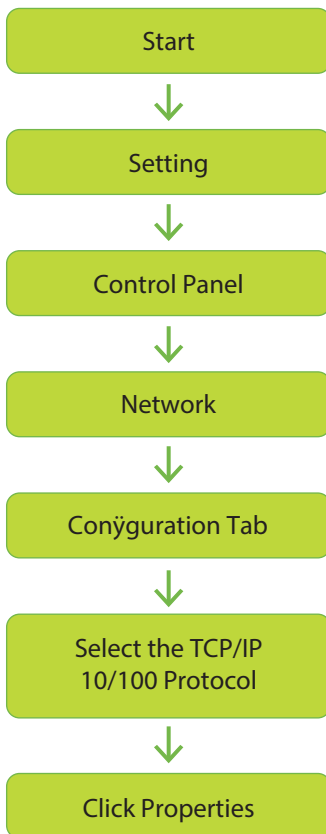

Note the settings under the IP Address, DNS Configuration, and Gateway tabs

2. Windows 2000 or XP Users

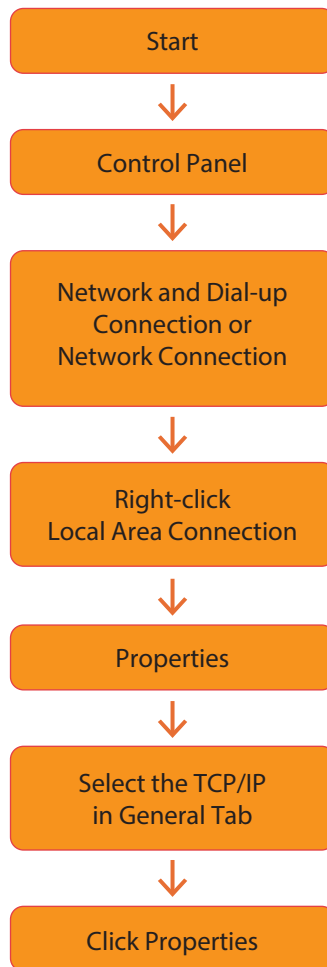

Under the 'General' tab of the TCP/IP Properties you will see your IP address information.

3. Windows Vista or 7 Users

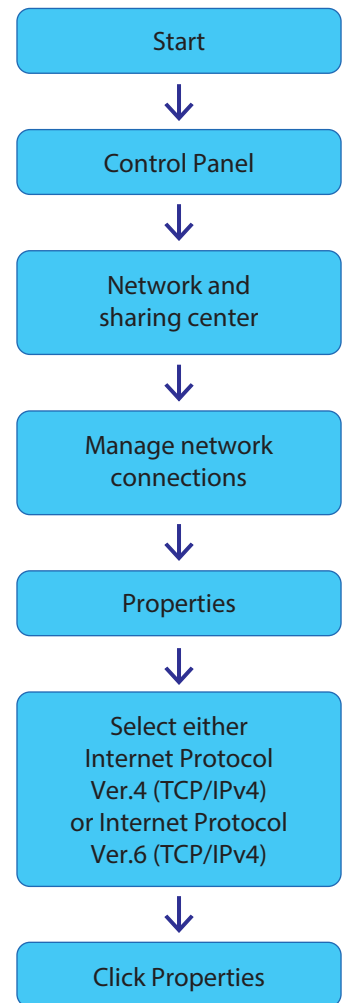

Under the 'General' tab of the TCP/IP Properties you will see your IP address information.

Appendix - B : Changing IP address and subnet mask

1. Windows 98 / ME Users

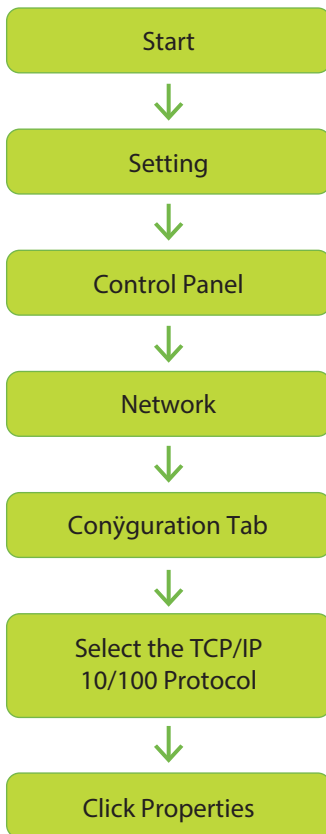

Select 'Use the following IP address' and change the IP address and Subnet Mask.

2. Windows 2000 or XP Users

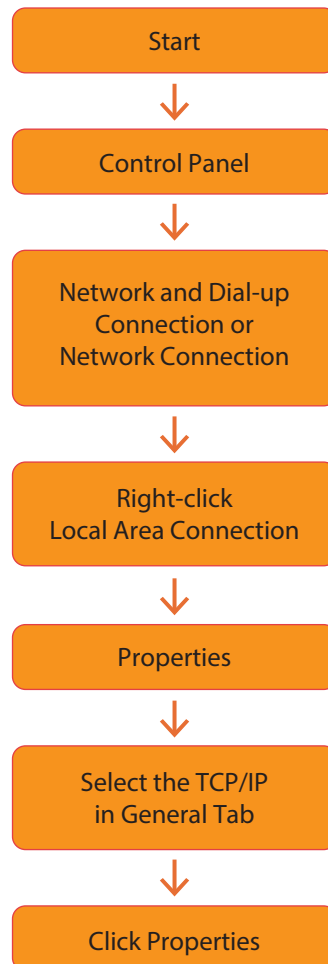

Select 'Use the following IP address'

3. Windows Vista or 7 Users

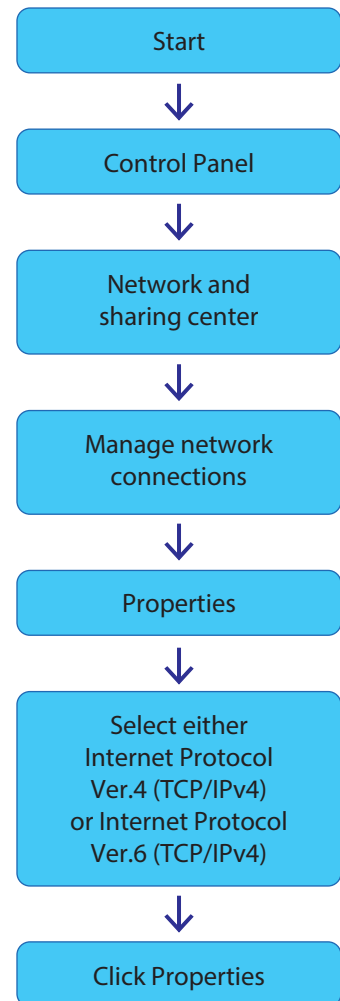

Select 'Use the following IP address'

Appendix - FAQ

1. My POWER light is not on?

Power is not being supplied to the unit. Please use the power supply shipped with the unit and verify that a power source is active from the attached power outlet used to connect the adapter. You can test this by plugging in any other electrical device and verify its operation. After using the power supply shipped with the product, checking the power source, and reinserting the power connector into the IP Camera, please call our Support Center. The power supply may be defective.

2. My ACTIVE light is not flashing?

Verify the power supply to the unit. Power off the unit and back on again, wait 1 minute, if the ACTIVE light still does not begin to flash, you will have to set the unit to its factory default (THIS WILL DELETE ANY CONFIGURATION AND SET THE UNIT TO THE FACTORY DEFAULTS). Power on the unit and insert the end of a paper clip into the small recessed opening on the back of the unit. Use the clip to press the button located within that opening.

3. My LINK light is not flashing or solid?

Verify the cable connection. 99% of the time the cable's connection to the unit is causing this problem. Try using a different network cable or crossover cable (for PC connection only). Try reinserting the cable, if this still doesn't solve the problem call our Support Center.

4. I can access the video server on my LAN, but not from the Internet.

Verify that your router (if applicable) has port forwarding properly configured. If accessing from our DDNS service, verify correct serial number. Firewall issues may prevent user access.

5. How do I open an MS-DOS or Command Prompt?

Start > (All) Programs > Accessories > Command Prompt

6. How do I find out my IP address information if my settings were automatically detected?

- 1) Open a Command Prompt
- 2) At the prompt type - "ipconfig / all" (without the quotes)
- 3) Near the end of the information supplied, should be your current IP address, subnet mask, default gateway and DNS servers

7. I can't connect!!

In the case of a connection failure.

Modem Reboot > Modem Reboot Finished > Router Reboot > Router Reboot Finished > IP Camera Reboot > IP Camera Reboot Finish > Verify DDNS and IP Camera connection, if applicable.

8. How do I "PING" an IP address?

- 1) Open an MS-DOS (or Command) prompt
- 2) At the prompt type - "ping xxx.xxx.xxx.xxx" (without the quotes and replace the "x"s with an IP address)
- 3) Press Enter

9. I'm accessing my video server remotely over the Internet and the video stream is choppy, is this normal?

Yes. The frames per second received remotely are determined by your bandwidth capabilities both at your site where the IP Camera is installed and your remote location. The lower of the two sites will determine how fast your video stream is received. It is recommended to have at least a 256Kb/sec upstream connection from the site where the IP Camera is installed. Lower speeds will operate properly, but provide poor remote performance. The Faster the Internet connection at both ends, the faster the video stream.

10. How do I enable or check VLC on my browser

Internet Explorer

Open Internet Explorer > Tools on the menu bar > Internet Options > Security Tab > Custom Level > Scroll down and verify that you are prompted or have enabled plug-ins to be downloaded and executed. > click OK > restart browser.

Chrome

Open Chrome > Chrome menu settings > Advanced settings > Individual information - content settings > Run automatically

11. How do I reset the unit to factory defaults?

On the underside of the unit you will find a recessed opening located near the top-left side of the label. Power ON the unit and use a paper clip to push the reset button within that opening. You should then see the ACTIVE light turn off and after a few seconds the ACTIVE light will begin to flash, signifying a successful reboot. If the ACTIVE light does not turn off after depressing the reset button, please try holding the button in for a few seconds and releasing. **YOU WILL LOSE ALL DATA THAT HAD BEEN ENTERED PREVIOUSLY AND THE IP CAMERA WILL BE SET TO ITS FACTORY RESETS.**

Specifications - Dimension

Unit: Inch (mm)

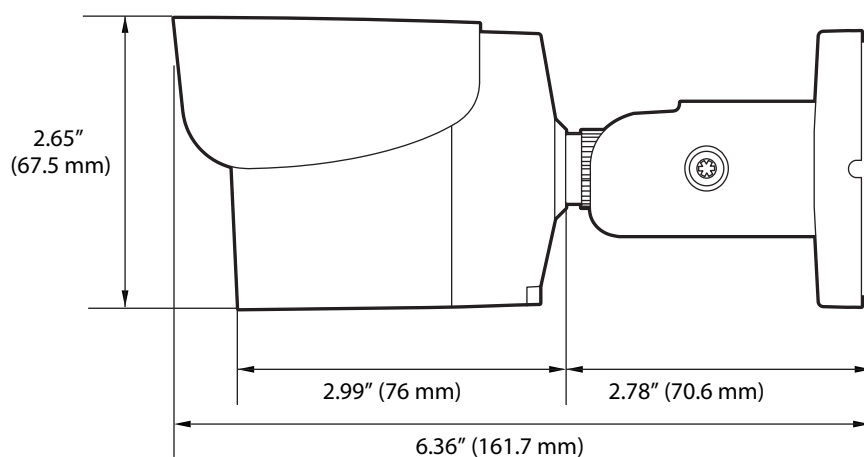
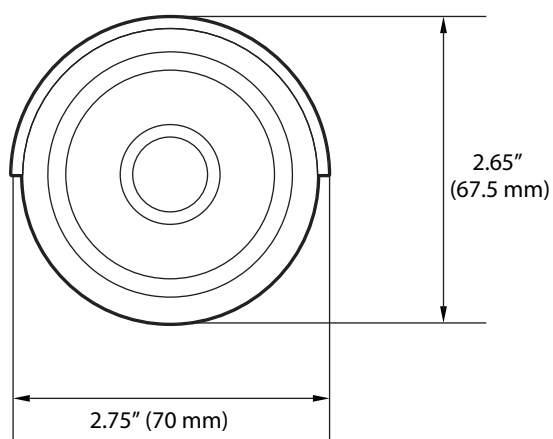

Warranty Information

Digital Watchdog (referred to as “the Warrantor”) warrants the Camera against defects in materials or workmanships as follows:

Labor: For the initial five (5) years from the date of original purchase if the camera is determined to be defective, the Warrantor will repair or replace the unit with new or refurbished product at its option, at no charge.

Parts: In addition, the Warrantor will supply replacement parts for the initial five (5) years.

To obtain warranty or out of warranty service, please contact a technical support representative at 1+ (866) 446-3595, Monday through Friday from 9:00AM to 8:00PM EST.

A purchase receipt or other proof of the date of the original purchase is required before warranty service is rendered. This warranty only covers failures due to defects in materials and workmanship which arise during normal use. This warranty does not cover damages which occurs in shipment or failures which are caused by products not supplied by the Warrantor or failures which result from accident, misuse, abuse, neglect, mishandling, misapplication, alteration, modification, faulty installation, set-up adjustments, improper antenna, inadequate signal pickup, maladjustments of consumer controls, improper operation, power line surge, improper voltage supply, lightning damage, rental use of the product or service by anyone other than an authorized repair facility or damage that is attributable to acts of God.

Limits & Exclusions

There are no express warranties except as listed above. The Warrantor will not be liable for incidental or consequential damages (including, without limitation, damage to recording media) resulting from the use of these products, or arising out of any breach of the warranty. All express and implied warranties, including the warranties of merchantability and fitness for particular purpose, are limited to the applicable warranty period set forth above.

Some states do not allow the exclusion or limitation of incidental or consequential damages or limitations on how long an implied warranty lasts, so the above exclusions or limitations may not apply to you. This warranty gives you specific legal rights, and you may also have other rights from vary from state to state.

If the problem is not handled to your satisfaction, then write to the following address:

Digital Watchdog, Inc.
ATTN: RMA Department
5436 W Crenshaw St
Tampa, FL 33634

Service calls which do not involve defective materials or workmanship as determined by the Warrantor, in its sole discretion, are not covered. Cost of such service calls are the responsibility of the purchaser.

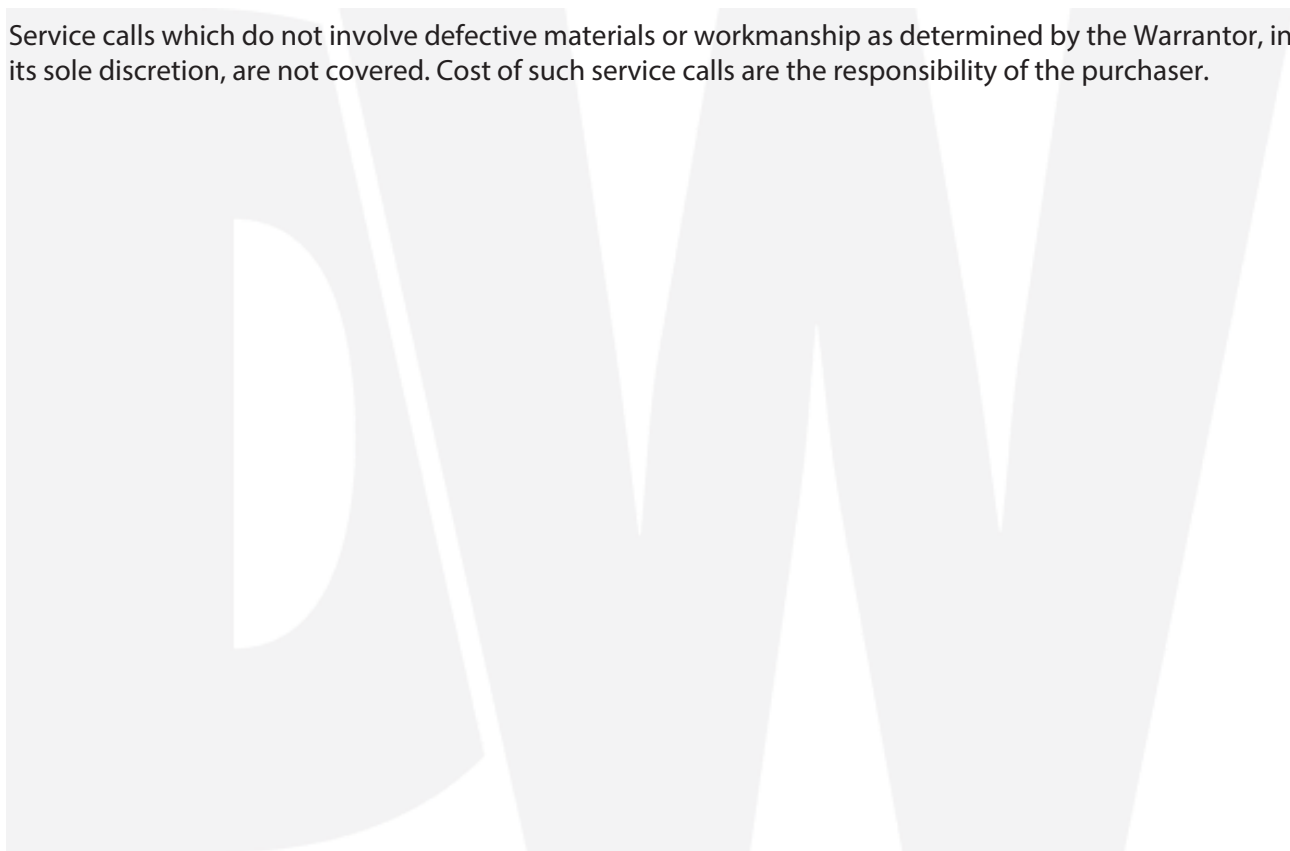



Complete Surveillance Solutions

Headquarters Office: 5436 W Crenshaw St, Tampa, FL 33634
Sales Office: 16220 Bloomfield Ave., Cerritos, California, USA 90703

PH: 866-446-3595 | FAX: 813-888-9262

www.Digital-Watchdog.com

technicalsupport@dwcc.tv

Technical Support PH:

USA & Canada 1+ (866) 446-3595

International 1+ (813) 888-9555

French Canadian 1+ (514) 360-1309

Technical Support Hours: Monday-Friday
9:00am to 8:00pm Eastern Standard Time