

# Caséta™ Wireless In-Wall Dimmer





The Caséta™ Wireless in-wall dimmer controls lighting loads automatically through wireless sensors and wireless remote controls, providing a system that delivers energy savings, convenience, and ease of installation.

The Caséta™ Wireless in-wall dimmer uses Lutron® patented Clear Connect® RF Technology, which enables wireless communication with Radio Powr Savr™ sensors and Pico® remote controls for total load control.

## Features

- The Caséta™ Wireless in-wall dimmer provides dimming of multiple load types and allows remote control and occupancy/vacancy sensing when paired with wireless transmitting devices.
- Lutron® patented Clear Connect® RF Technology works through walls and floors.
- Includes Front Accessible Service Switch (FASS™) for safe lamp replacement.
- Two-wire dimmer ideal for retrofit applications. No neutral required.
- Power failure memory: If power is interrupted, the control will return to its previously set level prior to interruption.
- Works with dimmable LEDs and CFLs as well as incandescent and halogen light bulbs.

## Load Types and Capacity\*

	<b>LED</b> up to 150 W		<b>CFL</b> up to 150 W
	<b>Halogen</b> up to 600 W		<b>Incandescent</b> up to 600 W

\* See **Ganging and Derating** section.

## Receiving Device Caséta™ Wireless In-Wall Dimmer

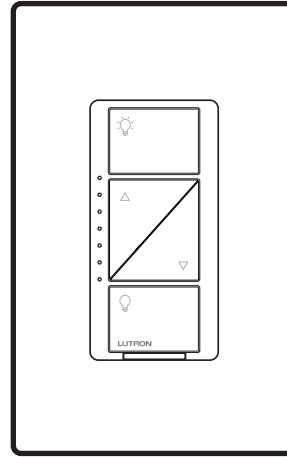

## Transmitting Devices Radio Powr Savr™ Sensors

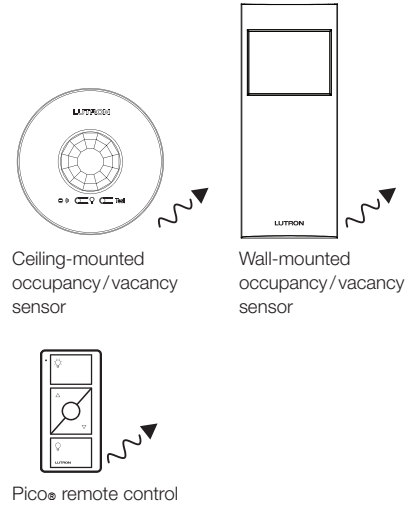

Job Name:	Model Numbers:
Job Number:	

## Specifications

### Regulatory Approvals

- cULus Listed
- NOM certified
- FCC Approved. Complies with the limits for a Class B digital device, pursuant to Part 15 of the FCC Rules
- Industry Canada certified
- COFETEL certified

### Power

Operating voltage:  
120 V~ 50/60 Hz

### Key Design Features\*

- Tested to withstand electrostatic discharge without damage or memory loss, in accordance with IEC 61000-4-2.
- Tested to withstand surge voltages without damage or loss of operation, in accordance with IEEE C62.41-1991 Recommended Practice on Surge Voltages in Low-Voltage AC Power Circuits.
- Dimmers always operate locally and do not require system control.
- Power failure memory: should power be interrupted, the control will return to its previously set level prior to the interruption when power is restored.
- Uses Lutron® Claro® wallplates or designer-style wallplates from other manufacturers. Wallplates are sold separately.
- Lutron® Claro® wallplates snap on with no visible means of attachment.
- Requires a 1-gang U.S. wallbox. 3½ in (89 mm) deep recommended, 2¼ in (57 mm) deep minimum.
- Green LEDs indicate load status.

### System Communications and Capacity

- The Caséta™ Wireless in-wall dimmer communicates with the Pico® remote controls and Radio Powr Savr™ sensors through radio frequency (RF).
- The Caséta™ Wireless in-wall dimmer must be located within 60 ft (18 m) line-of-sight or 30 ft (9 m) through walls, of Pico® remote controls and Radio Powr Savr™ sensors.
- Up to ten transmitting devices may be associated to each in-wall dimmer.

### Environment

- Ambient operating temperature: 32 °F to 104 °F (0 °C to 40 °C), 0%-90% humidity, non-condensing. Indoor use only.

\* For advanced features, tips on how to use Caséta™ Wireless dimmers with CFLs and LEDs, the complete Caséta™ Wireless product line, and more, please visit [www.casetawireless.com/features](http://www.casetawireless.com/features)

Job Name:	Model Numbers:
Job Number:	

# Operation

In-Wall Dimmer

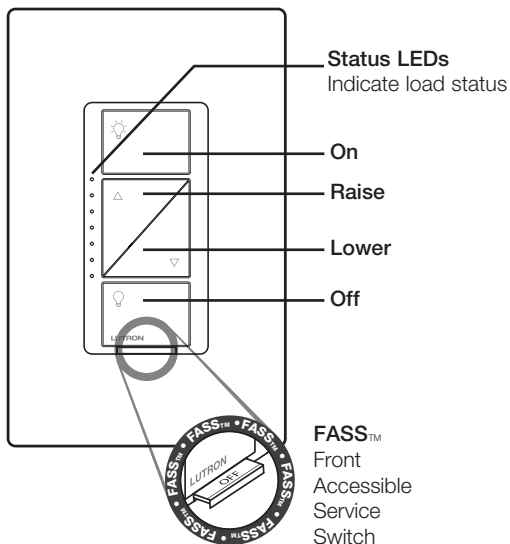

**IMPORTANT NOTICE:**  
**FASS™** - Front Accessible Service Switch - to service load, remove power by pulling the FASS™ switch out completely on Switch. After servicing load, push the FASS™ switch back in fully to restore power to the control.

# Mounting

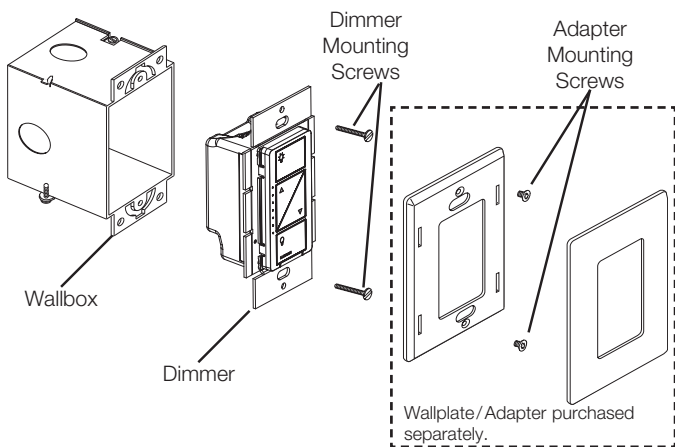

Job Name:	Model Numbers:
Job Number:	

### Dimensions

Front View

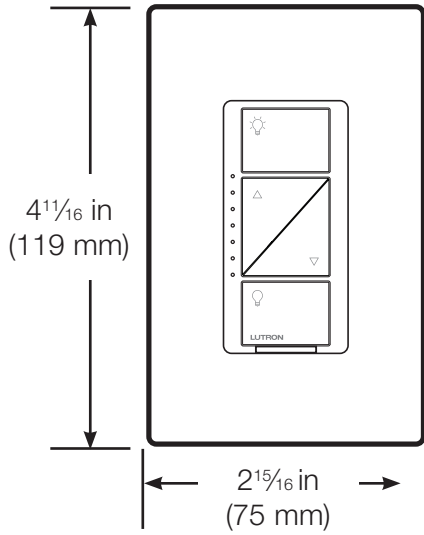

Side View

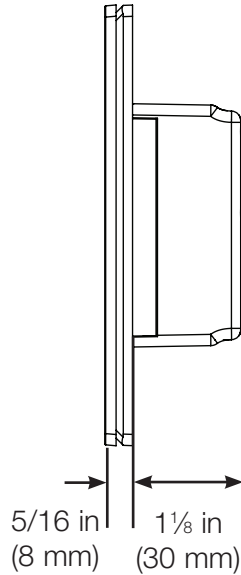

### Ganging and Derating

When ganging with other controls in the same wallbox, derating is required. See Load Type and Capacity chart.

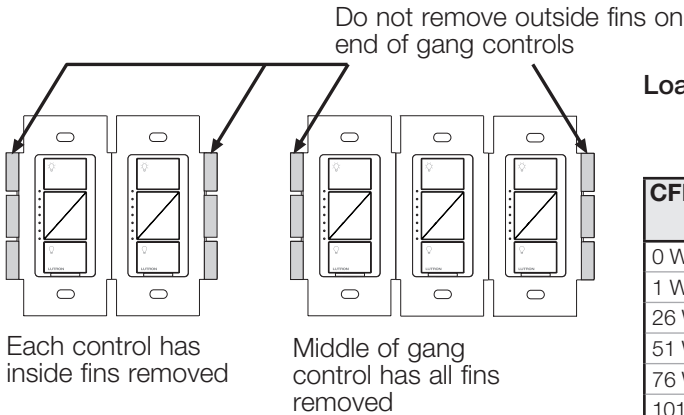

Load Type and Capacity\*

CFL/LED Total Wattage		Incandescent/Halogen Total Wattage		
		A	B	C
0 W	+	600 W	500 W	400 W
1 W – 25 W	+	500 W	400 W	300 W
26 W – 50 W	+	400 W	300 W	200 W
51 W – 75 W	+	300 W	200 W	100 W
76 W – 100 W	+	200 W	100 W	50 W
101 W – 125 W	+	100 W	50 W	0 W
126 W – 150 W	+	0 W	0 W	0 W

- Mixing bulb types (using a combination of CFL/LED and incandescent/halogen bulbs) reduces maximum wattage as shown in the chart above.
  - In-wall dimmer has a minimum load requirement of 25 W or one bulb from the compatible bulb list.
- \* See [www.casetawireless.com/bulblast](http://www.casetawireless.com/bulblast) for the latest list of compatible bulbs.

Job Name:	Model Numbers:
Job Number:	

## Wiring Diagrams

### Single Location Installation

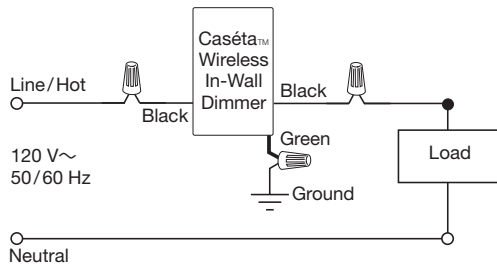

### Multi-Location Installation

With Pico® remote controls (PJ2-XX-XX) and wallbox mounting adapters (PICO-WBX-ADAPT)

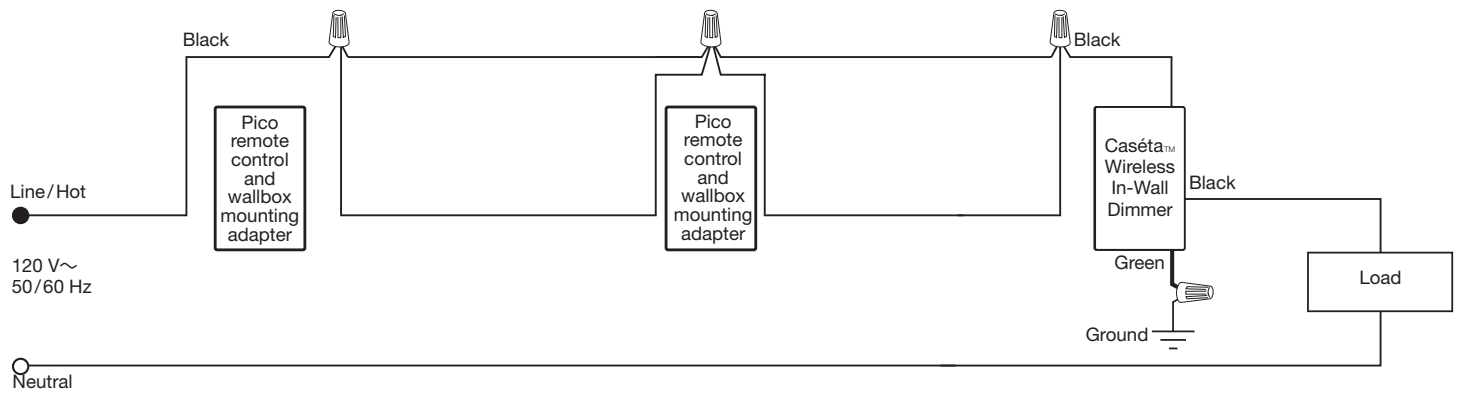

## Colors and Finishes

### Gloss Finishes

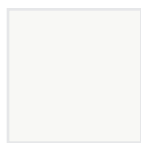

White  
WH

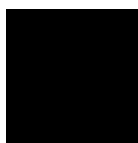

Black  
BL



Ivory  
IV

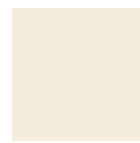

Light Almond  
LA

Due to printing limitations, colors and finishes shown cannot be guaranteed to perfectly match actual product colors.

Job Name:	Model Numbers:
Job Number:	