

CO1224T/CO1224TR Carbon Monoxide Detector

3825 Ohio Avenue, St. Charles, Illinois 60174
1-800-SENSOR2, FAX: 630-377-6583
www.systemsensor.com

SPECIFICATIONS

Electrical Specifications

System Voltage	Nominal: 12/24 VDC
	Min: 10 VDC
	Max: 33 VDC
Avg. Standby Current:	20 mA
Max Alarm Current:	40 mA (75 mA test)
Alarm Contact Ratings:	30 VDC @ 0.5 A
Trouble Contact Ratings:	30 VDC @ 0.5 A
Audible Signal (temp 4 tone):	85 dBA min. in alarm (at 10ft)
Max. Start-up Capacitance:	20 uF

Physical Specifications

Operating Temperature Range:	0° to 40°C (32° to 104°F)
Operating Humidity Range:	22 – 90% %RH
Diameter:	6.0"
Height:	1.25"
Weight:	7 oz
Wire Gauge Acceptance:	14-22 AWG

NOTICE: This manual shall be left with the owner/user of this equipment. This product is intended for use in ordinary indoor locations.

GENERAL DESCRIPTION

- Listed to UL standard 2075
- Round shape allows for mounting in aesthetically demanding areas
- Six-wire, system monitored
- Optional CO detector replacement plate for previously installed detectors
- Local sounder
- Low current draw
- Alarm relay, Form C
- Trouble relay, Form A
- Dual LED's
- Test/Hush button
- SEMS wiring terminals
- Mount to single gang electrical box or surface mount to wall or ceiling
- Optional drywall anchors included

TABLE 1. DETECTOR OPERATION MODES:

OPERATION MODE	GREEN LED	RED LED	SOUNDER
Normal (standby)	Blink 1 per minute	OFF	OFF
Alarm	OFF	Temp 4*pattern	Temp 4* pattern
Alarm Test	OFF	Temp 4 pattern	Temp 4 pattern
RealTest® Mode	Blink 1 per second	OFF	Temp 4 pattern (after CO is sprayed)
End of Life	OFF	OFF	OFF
CO Trouble	OFF	Blink 1 per minute	OFF
Power Loss/Cell Fault	OFF	OFF	OFF

FIGURE 1. ALARM LOCATION DIAGRAM:

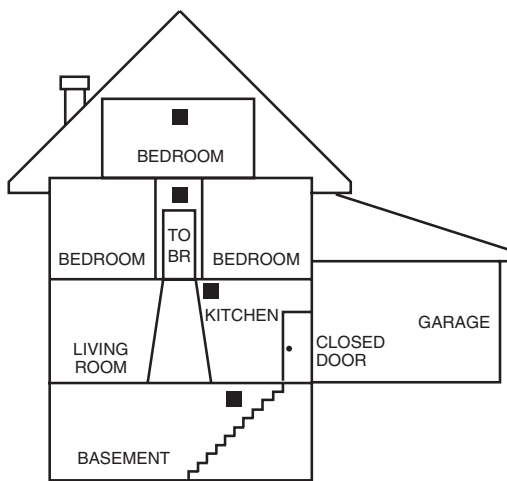

■ - CARBON MONOXIDE/SMOKE ALARM LOCATION FOR MULTI-LEVEL RESIDENCE

S0295-01

Alarm Test: Will send alarm signal to panel.

Hush feature/Alarm Silence: If required, the audible alarm can be silenced for 5 minutes by pushing the button marked "Test/Hush". The red alarm light will continue to flash in temp-4 pattern. If carbon monoxide is still present after the 5 minute hush period, the audible alarm will sound. The hush facility will not operate at levels above 350 ppm (parts per million) carbon monoxide.

RealTest® Alarm Silence: Alarm will automatically silence after about 20 seconds of alarm from spraying canned CO into the detector. Alarm Reset: Alarm automatically resets after CO has cleared from the sensor.

Trouble feature: When the sensor supervision is in a trouble condition (e.g. such as a sensor that has been tampered with, or the cell itself has prematurely dried out due to environmental conditions, etc.), the detector will send a trouble signal to the panel. The detector must then be replaced. The green LED turns off and the red LED blinks every minute when the detector is in trouble.

End of Life Timer feature: When the detector has reached the end of its life, the trouble contact will open. This indicates that the CO sensor inside the detector has passed the end of its life and must be replaced. This detector's lifespan is approximately ten years from the date of manufacture. The green LED turns off when the detector is in trouble. Periodically check the "Replace by" sticker located under the detector cover. The detector must be replaced by this date. Refer to Detector Replacement on page 3.

Per UL 2075, it is mandatory that a trouble signal be sent to the panel upon CO cell trouble or cell end of life. Refer to Figure 4 for wiring of the trouble relay.

INSTALLATION GUIDELINES

Ceiling: Detector should be at least 12 inches from any wall.

Wall: Detector should be at least as high as a light switch, and at least six inches from the ceiling.

- Do not install in any environment that does not comply with the detector's environmental specifications
- Install in accordance with NFPA 720—the Standard for the Installation of Carbon Monoxide (CO) Detection and Warning Equipment
- As of 2009, NFPA 720 defines standards for both commercial and residential installations of CO detectors. If the installation can be interpreted as a commercial application, consult the section of NFPA 720 that outlines commercial applications.
- For example, Chapter 5.5.5.3.1 states that carbon monoxide detectors shall be installed in accordance with manufacturers published instructions in the following locations:
 - (1) On the ceiling in the same room as permanently installed fuel burning appliances
 - (2) Centrally located on every habitable level and in every HVAC zone of the building
- If the installation can be interpreted as residential, consult the section of NFPA 720 that outlines residential applications.
- For example, chapter 9.4.1.1 states that carbon monoxide alarms or detectors shall be installed as follows:
 - (1) Outside each separate dwelling unit sleeping area in the immediate vicinity of the bedrooms
 - (2) On every level of a dwelling unit, including basements
 - (3) Other locations where required by applicable laws, codes or standards

MOUNTING

The CO1224T/CO1224TR can be ceiling-mounted or wall-mounted:

1. To a single gang box.
2. Direct mount to ceiling or to wall using drywall fasteners.

FIGURE 2. MOUNTING OF DETECTOR:

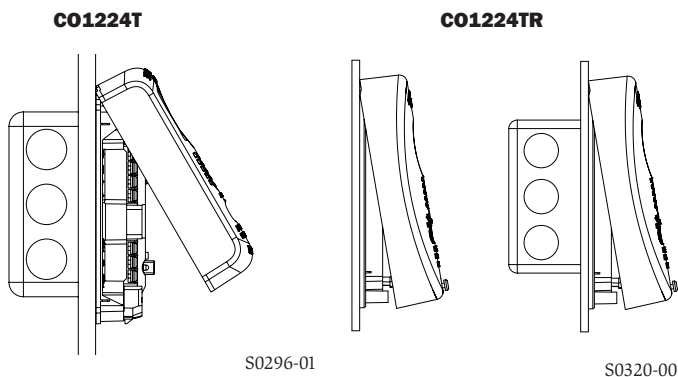

INSTALLATION

WIRING INSTALLATION GUIDELINES

All wiring must be installed in compliance with the NFPA 70, National Electrical Code, applicable state and local codes, and any special requirements of the local Authority Having Jurisdiction (AHJ).

Proper wire gauges should be used. The conductors used to connect carbon monoxide detectors to the alarm control panel and accessory devices should be color-coded to reduce the likelihood of wiring errors. Improper connections can prevent a system from responding properly in the event of a CO.

The screw terminals in the mounting base will accept 14-22 gauge wire. Wire connections are made by stripping approximately 1/4" of insulation from the end of the feed wire, inserting it into the proper base terminal, and tightening the screw to secure the wire in place. Do not put wires more than 2 gauge apart under the same clamping plate.

WARNING: This product does not have a local audible trouble signal, and may fail without supervision if trouble loop remains unconnected.

WARNING: Gas detectors on a zone that is bypassed may not signal a trouble condition. Do not bypass zones used for gas detectors.

Wiring diagrams located on page 4, Figure 4.

WARNING

Remove power from alarm control unit or initiating device circuits before installing detectors.

1. Using a small, flat head screw driver, push in the small tab located on the underside of the detector. Once the snap is loosened, lift the bottom end of the cover up and unhinge the top to remove the cover.
2. Wire the detector base screw terminals per Figure 5.
3. Screw the base of the detector onto a single gang electrical box, or to the surface of the wall or ceiling. Use the hardware included in the packaging.
4. If mounting with the System Sensor replacement plate model CO-PLATE*:
 - * Hold replacement plate over desired mounting area.
 - * Use hook feature to hold CO1224T onto the replacement plate.
 - * Mount detector and plate together using hardware provided with the CO1224T.
5. Hinge the top portion of the cover onto the base; with the cover at a 45 degree angle, fit the hinges into the slots of the base.
6. Push the unhinged bottom portion of the cover down until it snaps into place.
7. After all detectors have been installed, apply power to the alarm control unit.
8. Test each detector as described in Testing.
9. Notify the proper authorities that the system is in operation.

CAUTION

Airborne dust particles can enter the detector. System Sensor recommends the installation of detectors after construction or any other dust producing activity. Carbon monoxide detectors are not to be used with detector guards unless the combination has been evaluated and found suitable for that purpose.

TESTING

Detector must be tested after installation.

NOTE: Before testing, notify the proper authorities to avoid any nuisance alarms.

Ensure proper wiring and power is applied. After power up, allow 80 seconds for the detector to stabilize before testing.

Test the CO1224T/CO1224TR detector as follows:

1. A test button is located on the detector housing (See Figure 4).
2. Use the tip of your finger to press and hold the test button for 1-4 seconds.
3. If the sounder beeps twice in the Temporal 4 tone and the LED's light up, the detector is operational.
4. The detector now enters Realtest speed up test mode indicated by a quickly blinking green LED. See Functional Gas Test section for instructions on testing with canned CO.

If a detector fails the above test method, its wiring should be checked. If the detector still fails after rewiring, it should be replaced.

FIGURE 4. TEST BUTTON LOCATION AND OPERATION:

CO1224T

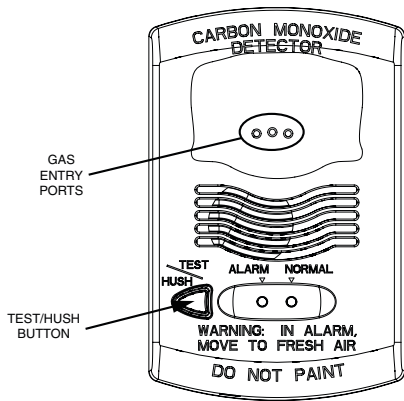

S0298-00

CO1224TR

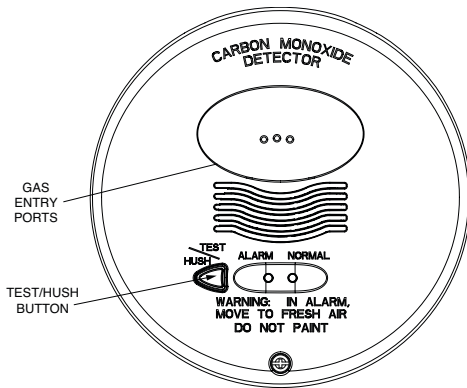

S0321-00

FUNCTIONAL GAS TEST

NOTE: Check with local codes and the AHJ to determine whether or not a functional gas test is necessary for an installation.

Solo C6 brand canned CO testing agent may be used to verify the detector's ability to sense CO by utilizing the RealTest® feature of the CO1224T/CO1224TR as follows:

1. Press the test button as described in Testing above.
2. Once the alarm has entered the speed-up test mode, indicated by a quickly flashing green LED, spray a small amount of CO agent within 1/4" of the alarm's gas entry ports (see Figure 3). The unit will go into alarm if gas entry is successful.
3. The detector will automatically exit the speed-up test mode 20-60 seconds after entering speed-up test mode.

Testing the detector will activate the alarm relay and send a signal to the panel.

CAUTION: This carbon monoxide detector is designed for indoor use only. Do not expose to rain or moisture. Do not knock or drop the detector. Do not open or tamper with the detector as this could cause malfunction. The detector will not protect against the risk of carbon monoxide poisoning if not properly wired. The detector will only indicate the presence of carbon monoxide gas at the sensor. Carbon monoxide gas may be present in other areas.

This carbon monoxide detector is NOT:

- Designed to detect smoke, fire or any gas other than carbon monoxide
- To be seen as a substitute for the proper servicing of fuel-burning appliances or the sweeping of chimneys.
- To be used on an intermittent basis, or as a portable alarm for the spillage of combustion products from fuel-burning appliances or chimneys.
- To be used in airplanes or any other aeronautical vehicle.

Carbon monoxide gas is a highly poisonous gas which is released when fuels are burnt. It is invisible, has no smell and is therefore impossible to detect with the human senses. Under normal conditions in a room where fuel burning appliances are well maintained and correctly ventilated, the amount of carbon monoxide released into the room by appliances should not be dangerous.

Symptoms of carbon monoxide poisoning: Carbon monoxide bonds to the hemoglobin in the blood and reduces the amount of oxygen being circulated in the body. The following symptoms are examples taken from NFPA 720. They represent approximate values for healthy adults:

Concentration (ppm CO)	Symptoms
200	Mild headache after 2-3 hours of exposure
400	Headache and nausea after 1-2 hours of exposure
800	headache, nausea, and dizziness after 45 minutes of exposure; collapse and unconsciousness after 2 hours of exposure

Many causes of reported carbon monoxide poisoning indicate that while victims are aware that they are not well, they become so disoriented that they are unable to save themselves by either exiting the building or calling for assistance. Young children and pets may be the first to be affected.

Per UL standard 2075, the CO1224T/CO1224TR has been tested to the sensitivity limits defined in UL standard 2034.

Alarm thresholds are as follows:

Parts Per Million	Detector response time, min.
30 ± 3ppm	No alarm within 30 days
70 ± 5ppm	60-240
150 ± 5ppm	10-50
400 ± 10ppm	4-15

What to do if the carbon monoxide detector goes into alarm:

Immediately move to a spot where fresh air is available, preferably outdoors. Find a phone in an area where the air is safe and call your security service provider. Tell your provider the detector alarm status, and that you require professional assistance in ridding your home of the carbon monoxide.

IMPORTANT: This detector should be tested and maintained regularly following National Fire Protection Association (NFPA) 720 requirements.

MAINTENANCE

Occasionally clean the outside casing with a cloth. Ensure that the holes on the front of the alarm are not blocked with dirt and dust.

Do not paint, and do not use cleaning agents, bleach, or polish on the detector.

DETECTOR REPLACEMENT

This detector is manufactured with a long-life carbon monoxide sensor. Over time the sensor will lose sensitivity, and will need to be replaced with a new System Sensor carbon monoxide detector. This detector's lifespan is approximately ten years from the date of manufacture.

Periodically check the detector's replacement date. Remove the detector cover and refer to the sticker placed on the inside of the detector. The sticker will indicate the date that the detector shall be replaced.

This detector is also equipped with a feature that will open the trouble relay once it has reached the end of its useful life. If this occurs, it is time to replace the detector.

NOTE: Before replacing the detector, notify the proper authorities that maintenance is being performed and the system will be temporarily out of service. Disable the zone or system undergoing maintenance to prevent any unwanted alarms. Dispose of detector in accordance with any local regulations.

FIGURE 5. WIRING DIAGRAM:

SINGLE UNIT, SINGLE ZONE, 4 CONDUCTOR CABLE

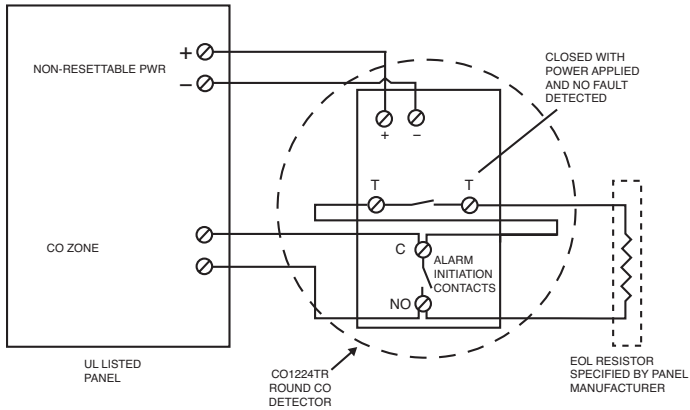

S0313-01

CAUTION

It should be noted the installation, operation, testing and maintenance of the CO1224T/CO1224TR is different than System Sensor conventional 4-wire smoke detectors, such as the i3 Series. Below are specific installation requirements for the CO1224T/CO1224TR:

- Connect to a non-resettable power supply
- Connect to a non-fire zone: Per NFPA 720 section 9.6.7.2 the CO1224T/CO1224TR shall not be connected to a zone that signals a fire condition
- Per NFPA 720 section 9.6.7, do not connect the CO1224T/CO1224TR on a zone with other fire or intrusion initiating devices - i.e. do not connect on the same zone as smoke detectors
- Wiring of the trouble relay is mandatory: Per UL Standard 2075 section 17.1.1 a detector shall send a trouble signal to the control panel upon an open circuit, a ground fault, sensor removal or sensor end of life
- If wiring one CO1224T/CO1224TR per zone: Use 4 conductors
- If wiring multiple CO1224T/CO1224TR detectors per zone: Use 4 conductors from panel to first CO1224T/CO1224TR, then use 6 conductors from the second CO1224T/CO1224TR to other detectors on the zone

MULTIPLE UNIT, SINGLE ZONE, 6 CONDUCTOR CABLE

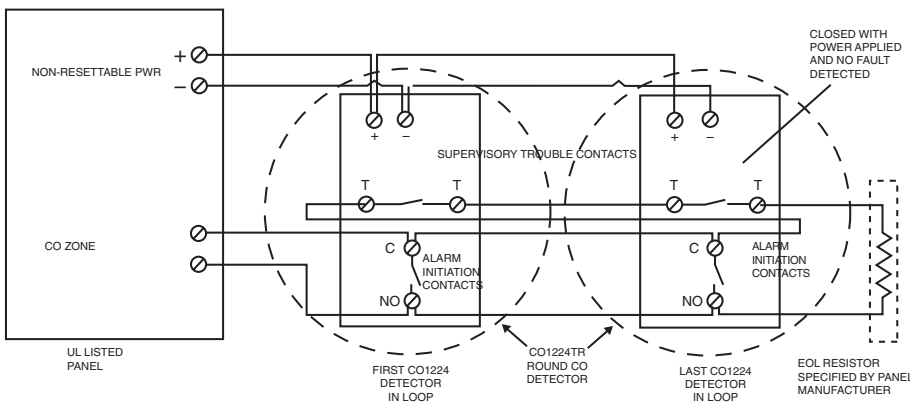

S0314-01

Input powered (12 or 24 VDC) from UL Listed Fire/Burg Control Panel (Class 2).

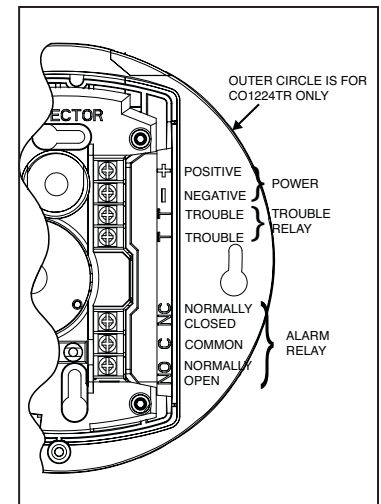

S0322-01

Please refer to insert for the limitations of Carbon Monoxide Detectors

FCC STATEMENT

This device complies with part 15 of the FCC Rules. Operation is subject to the following two conditions: (1) This device may not cause harmful interference, and (2) this device must accept any interference received, including interference that may cause undesired operation.

NOTE: This equipment has been tested and found to comply with the limits for a Class B digital device, pursuant to Part 15 of the FCC Rules. These limits are designed to provide reasonable protection against harmful interference in a residential installation. This equipment generates, uses and can radiate radio frequency energy and, if not installed and used in accordance with the instructions, may cause harmful interference to radio communications. However, there is no guarantee that interference will not occur in a particular installation. If this equipment does cause harmful interference to radio or television reception, which can be determined by turning the equipment off and on, the user is encouraged to try to correct the interference by one or more of the following measures:

- Reorient or relocate the receiving antenna.
- Increase the separation between the equipment and receiver.
- Connect the equipment into an outlet on a circuit different from that to which the receiver is connected.
- Consult the dealer or an experienced radio/TV technician for help.

THREE-YEAR LIMITED WARRANTY

System Sensor warrants its enclosed product to be free from defects in materials and workmanship under normal use and service for a period of three years from date of manufacture. System Sensor makes no other express warranty for the enclosed product. No agent, representative, dealer, or employee of the Company has the authority to increase or alter the obligations or limitations of this Warranty. The Company's obligation of this Warranty shall be limited to the replacement of any part of the product which is found to be defective in materials or workmanship under normal use and service during the three year period commencing with the date of manufacture. After phoning System Sensor's toll free number 800-SENSOR2 (736-7672) for a Return Authorization number, send defective units postage prepaid to: Honeywell, 12220 Rojas Drive, Suite 700, El Paso

TX 79936, USA. Please include a note describing the malfunction and suspected cause of failure. The Company shall not be obligated to replace units which are found to be defective because of damage, unreasonable use, modifications, or alterations occurring after the date of manufacture. In no case shall the Company be liable for any consequential or incidental damages for breach of this or any other Warranty, expressed or implied whatsoever, even if the loss or damage is caused by the Company's negligence or fault. Some states do not allow the exclusion or limitation of incidental or consequential damages, so the above limitation or exclusion may not apply to you. This Warranty gives you specific legal rights, and you may also have other rights which vary from state to state.

System Sensor® is a registered trademark of Honeywell International, Inc.