







NS2052-8P-2C Industrial PoE+ Switch User Manual

Copyright	© 2018 United Technologies Corporation. Interlogix is part of UTC Climate, Controls & Security, a unit of United Technologies Corporation. All rights reserved.
Trademarks and patents	Trade names used in this document may be trademarks or registered trademarks of the manufacturers or vendors of the respective products.
Manufacturer	Interlogix 2955 Red Hill Avenue, Costa Mesa, CA 92626-5923, USA Authorized EU manufacturing representative: UTC Fire & Security B.V. Kelvinstraat 7, 6003 DH Weert, The Netherlands
Version	This document applies to NS2052-8P-2C.
FCC compliance	This device complies with part 15 of the FCC Rules. Operation is subject to the following two conditions: (1) This device may not cause harmful interference, and (2) this device must accept any interference received, including interference that may cause undesired operation.
FCC compliance	Class A: This equipment has been tested and found to comply with the limits for a Class A digital device, pursuant to part 15 of the FCC Rules. These limits are designed to provide reasonable protection against harmful interference when the equipment is operated in a commercial environment. This equipment generates, uses, and can radiate radio frequency energy and, if not installed and used in accordance with the instruction manual, may cause harmful interference to radio communications. Operation of this equipment in a residential area is likely to cause harmful interference in which case the user will be required to correct the interference at his own expense.
Canada	This Class A digital apparatus complies with CAN ICES-003 (A)/NMB-3 (A). Cet appareil numérique de la classe A est conforme à la norme CAN ICES-003 (A)/NMB-3 (A).
ACMA compliance	Notice! This is a Class A product. In a domestic environment this product may cause radio interference in which case the user may be required to take adequate measures.
Certification	  
EU directives	This product and - if applicable - the supplied accessories too are marked with "CE" and comply therefore with the applicable harmonized European standards listed under the EMC Directive 2014/30/EU, the RoHS Directive 2011/65/EU.
	2012/19/EU (WEEE directive): Products marked with this symbol cannot be disposed of as unsorted municipal waste in the European Union. For proper recycling, return this product to your local supplier upon the purchase of equivalent new equipment, or dispose of it at designated collection points. For more information see: www.recyclethis.info .

Product warnings and disclaimers

THESE PRODUCTS ARE INTENDED FOR SALE TO AND INSTALLATION BY QUALIFIED PROFESSIONALS. UTC FIRE & SECURITY CANNOT PROVIDE ANY ASSURANCE THAT ANY PERSON OR ENTITY BUYING ITS PRODUCTS, INCLUDING ANY "AUTHORIZED DEALER" OR "AUTHORIZED RESELLER", IS PROPERLY TRAINED OR EXPERIENCED TO CORRECTLY INSTALL FIRE AND SECURITY RELATED PRODUCTS.

For more information on warranty disclaimers and product safety information, please check www.firesecurityproducts.com/policy/product-warning/ or scan the following code:



Contact information and manuals

For contact information go to: www.interlogix.com or www.firesecurityproducts.com.

To get translations for this and other product manuals go to: www.firesecurityproducts.com.

Content

	Important information	2
Chapter 1	Package contents	3
	Package contents	3
Chapter 2	Hardware introduction	4
	Physical dimensions	4
	Product features	9
	Product specifications	10
Chapter 3	Installation	13
	DIN-rail mounting	13
	Wall mount plate mounting	15
	Installing the SFP transceiver	15
Chapter 4	Troubleshooting	18
Appendix A	Networking connection	19
Appendix B	Approved Interlogix SFP transceivers	22

Important information

Limitation of liability

To the maximum extent permitted by applicable law, in no event will UTCFS be liable for any lost profits or business opportunities, loss of use, business interruption, loss of data, or any other indirect, special, incidental, or consequential damages under any theory of liability, whether based in contract, tort, negligence, product liability, or otherwise. Because some jurisdictions do not allow the exclusion or limitation of liability for consequential or incidental damages the preceding limitation may not apply to you. In any event the total liability of UTCFS shall not exceed the purchase price of the product. The foregoing limitation will apply to the maximum extent permitted by applicable law, regardless of whether UTCFS has been advised of the possibility of such damages and regardless of whether any remedy fails of its essential purpose.

Installation in accordance with this manual, applicable codes, and the instructions of the authority having jurisdiction is mandatory.

While every precaution has been taken during the preparation of this manual to ensure the accuracy of its contents, UTCFS assumes no responsibility for errors or omissions.

Advisory messages

Advisory messages alert you to conditions or practices that can cause unwanted results. The advisory messages used in this document are shown and described below.

WARNING: Warning messages advise you of hazards that could result in injury or loss of life. They tell you which actions to take or to avoid in order to prevent the injury or loss of life.

Caution: Caution messages advise you of possible equipment damage. They tell you which actions to take or to avoid in order to prevent damage.

Note: Note messages advise you of the possible loss of time or effort. They describe how to avoid the loss. Notes are also used to point out important information that you should read.

Chapter 1

Package contents

The description of the IFS NS2052-8P-2C model is as follows:

- Industrial 8-port 10/100TX 802.3at PoE+
- + 2-port TP/SFP combo Ethernet switch

Unless specified, the term “industrial PoE+ switch” mentioned in this user manual refers to the NS2052-8P-2C.

Package contents

Open the box of the industrial PoE+ switch and carefully unpack it. The box should contain the following items:

- The industrial PoE+ switch × 1
- CD with user manual × 1
- DIN rail kit x 1
- Wall mounting kit x 1

If any of these are missing or damaged, contact your dealer immediately. If possible, retain the carton including the original packing materials for repacking the product in case there is a need to return it to us for repair.

Chapter 2

Hardware introduction

Physical dimensions

Dimensions (W x D x H): 161 x 107 x 72 mm

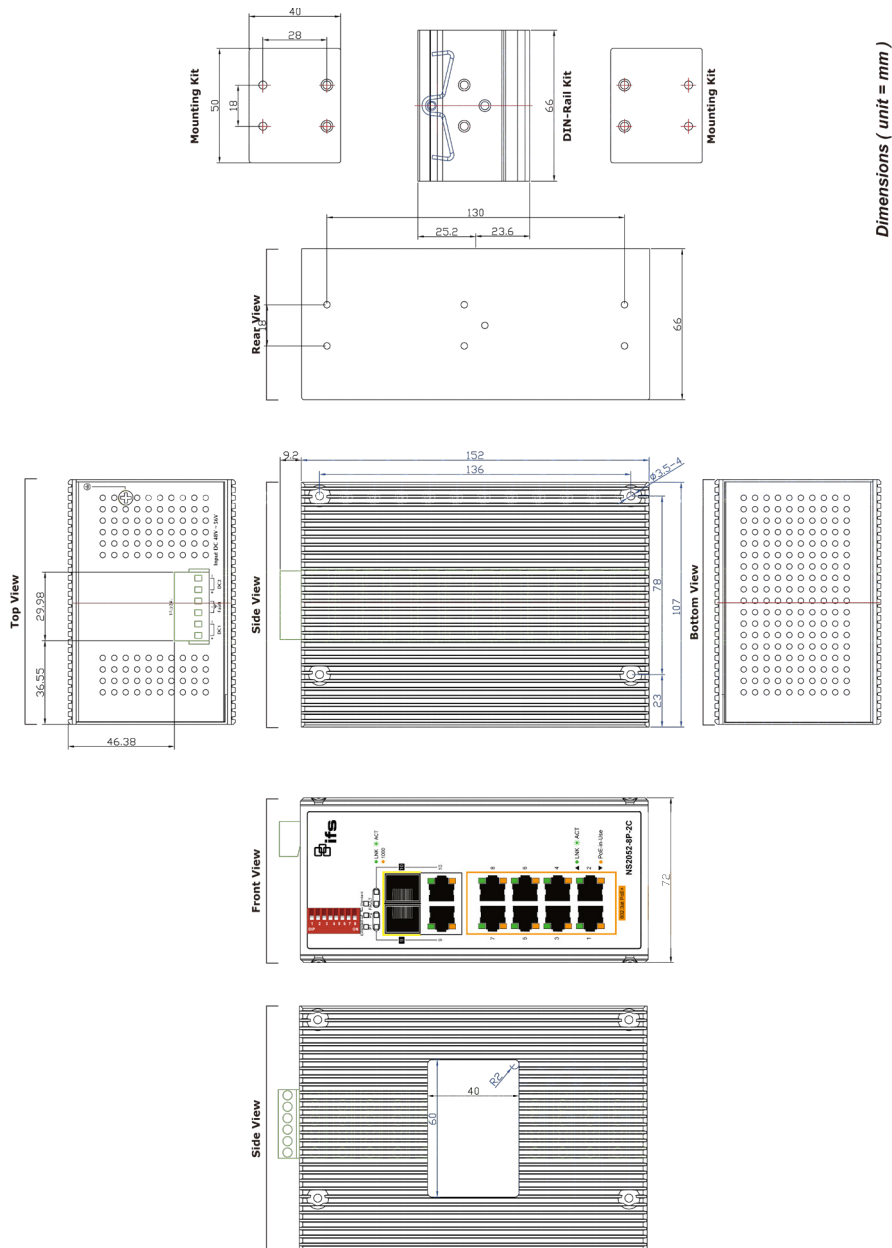

Dimensions (unit = mm)

Front panel

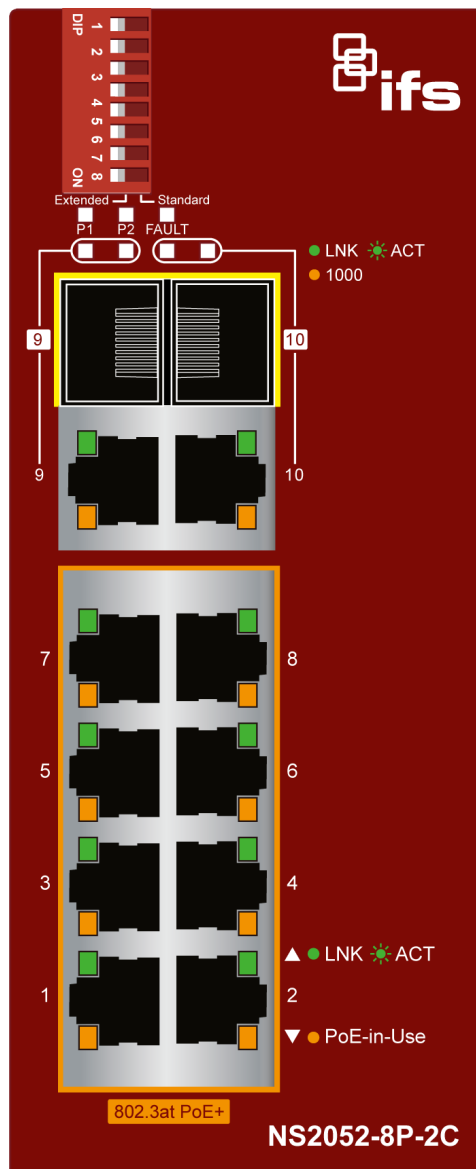

Fast Ethernet TP interfaces (port 1 to port 8)

10/100BASE-TX copper, RJ45 twisted-pair: Up to 100 meters.

Gigabit TP interfaces (port 9 to port 10 TP/SFP combo interfaces)

10/100/1000BASE-T copper, RJ45 twisted-pair: Up to 100 meters.

Gigabit SFP slots (port 9 to port 10 TP/SFP combo interfaces)

1000BASE-SX/LX mini-GBIC slot, SFP (Small-form Factor Pluggable) transceiver module: From 550 meters (multi-mode fiber) and to 10/20/30/40/50/70/120 kilometers (single-mode fiber).

DIP switch

The industrial PoE+ switch has a built-in solid DIP switch that provides “Standard” and “Extend” operation modes. The industrial PoE+ switch operates as a normal IEEE 802.af/at PoE+ Switch in the “Standard” operation mode.

In the “Extend” operation mode, the industrial PoE+ switch operates on a per-port basis at 10 Mbps full duplex operation but can support 30 W PoE power output over a distance of up to 250 meters, overcoming the 100 m limit on Ethernet UTP cable. With this brand-new feature, the industrial PoE+ switch provides an additional solution for 802.3af/at PoE+ distance extension.

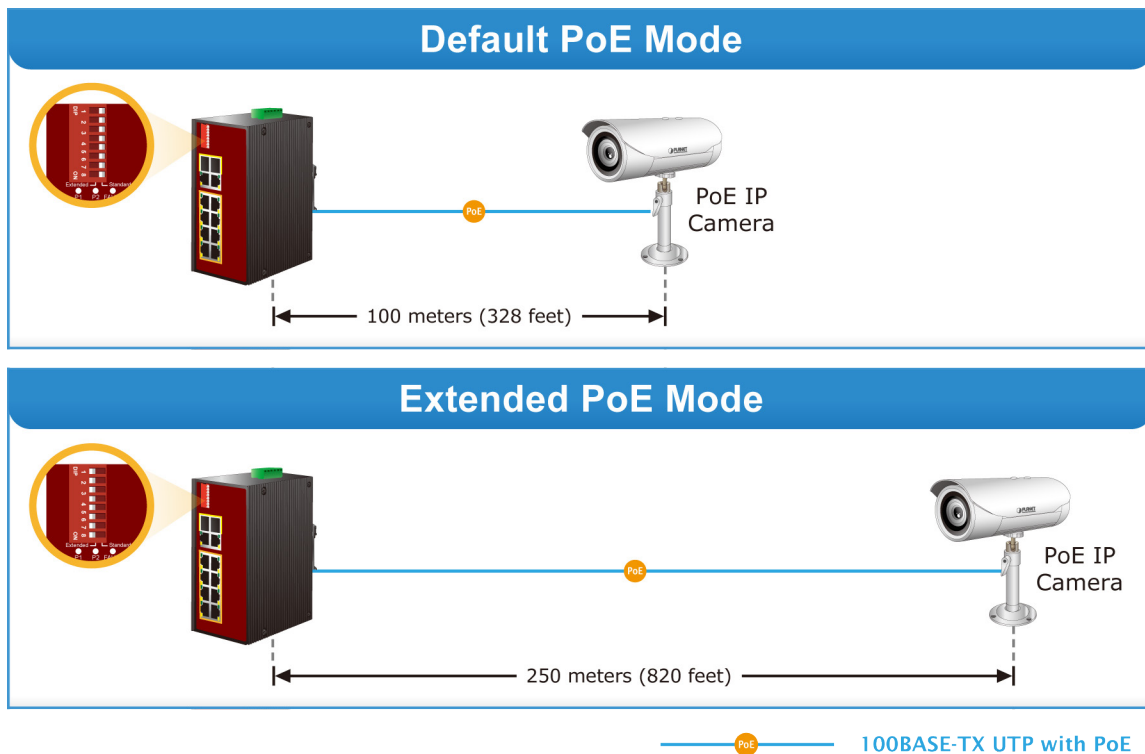

LED indicators

The front panel LEDs indicate port link status, data activity, and system power.

picture

System

LED	Color	Function
P1	Green	Lit: indicates that the power input 1 has power.
P2	Green	Lit: indicates that the power input 2 has power.
Fault	Red	Lit: indicates that either power 1 or power 2 has no power.

Per 802.3at PoE+ 10/100BASE-TX interface (port 1 to port 8)

LED	Color	Function
LNK/ACT	Green	Lit: indicates the port has successfully connected to the network at 10 Mbps or 100 Mbps. Blinking: indicates that the switch is actively sending or receiving data over that port.
PoE In-use	Orange	Lit: indicates the port is providing DC in-line power. Off: indicates that the connected device is not a PoE powered device (PD).

Per 10/100/1000BASE-T interface (shared with port 9 to port 10)

LED	Color	Function
LNK/ACT	Green	Lit: indicates the port has successfully connected to the network at 10/100/1000 Mbps. Blinking: indicates that the switch is actively sending or receiving data over that port.
1000	Orange	Lit: indicates the port has successfully connected to the network at 1000 Mbps. Off: indicates that the link through that port has successfully connected to the network at 10/100 Mbps.

Per 1000X SFP slot (shared with port 9 to port 10)

LED	Color	Function
LNK/ACT	Green	Lit: indicates the port has successfully connected to the network at 1000 Mbps. Blinking: indicates that the switch is actively sending or receiving data over that port.
1000	Orange	Lit: indicates the port has successfully connected to the network at 1000 Mbps. Off: indicates that the link through that port is not established.

Switch upper panel

The upper panel of the industrial PoE+ switch consists of one terminal block connector within two DC power inputs.

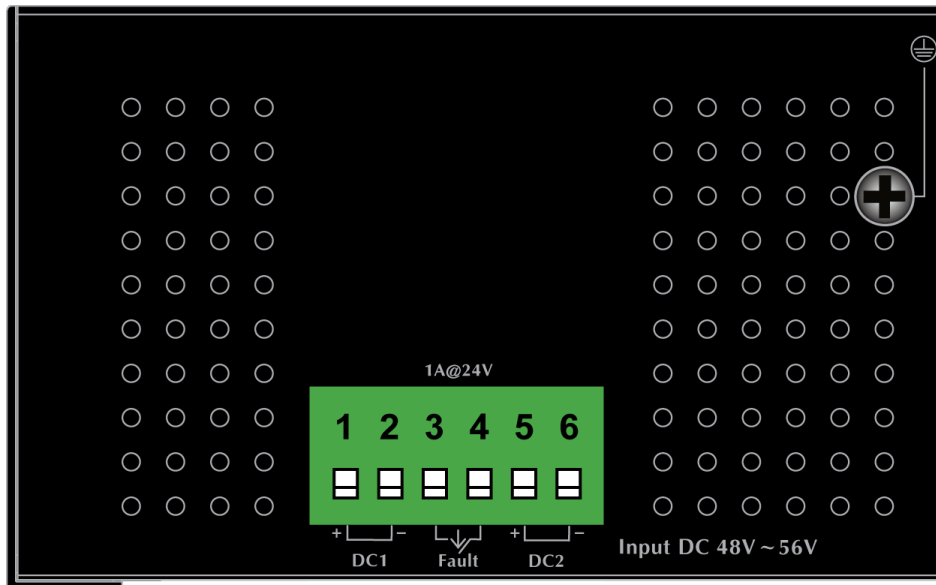

Wiring the power inputs

The 6-contact terminal block connector on the top panel of Industrial PoE+ switch is used for two DC redundant power inputs. Follow the steps below to insert the power wire.

Caution: When performing any of the procedures like inserting the wires or tightening the wire-clamp screws, make sure the power is OFF to prevent from getting an electric shock.

1. Insert positive/negative DC power wires into contacts 1 and 2 for DC Power 1, or 5 and 6 for DC Power 2.

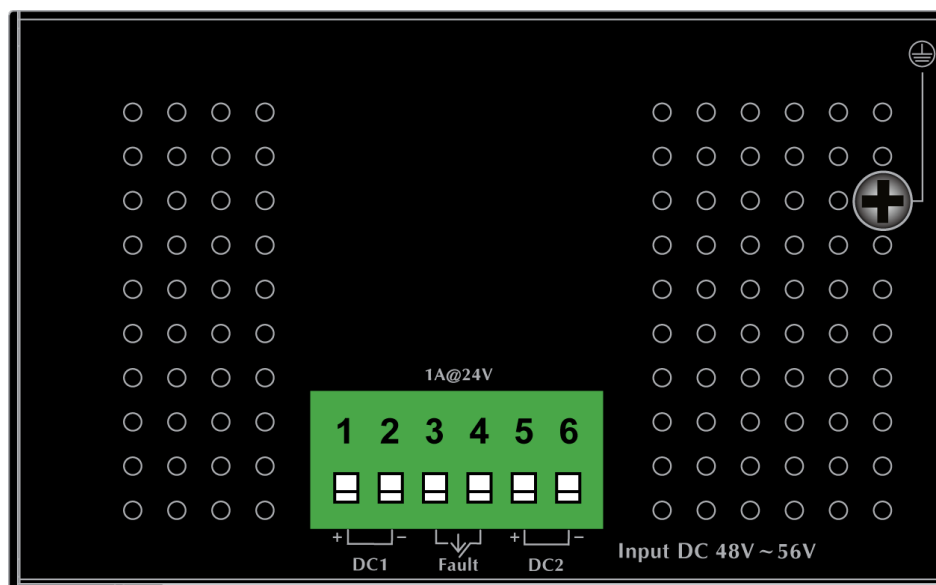

2. Tighten the wire-clamp screws to prevent the wires from loosening.

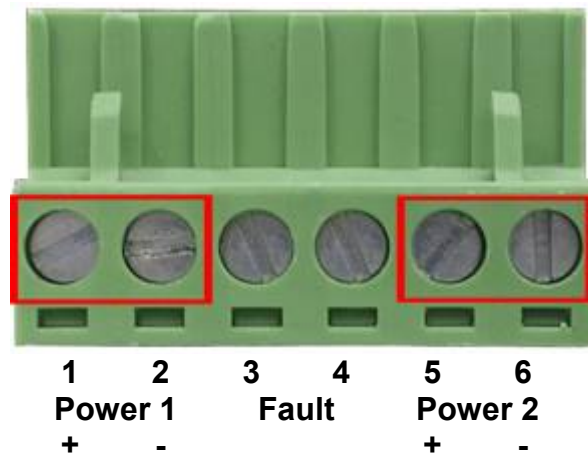
**Note:**

1. The wire gauge for the terminal block should be in the range of 12 to 24 AWG.
2. The DC power input range is 48 to 56 VDC.

Wiring the fault alarm contact

The fault alarm contacts are in the middle of the terminal block connector as the picture shows below. Inserting the wires, the industrial PoE+ switch detects the fault status of the power failure and then forms an open circuit. The following illustration shows an application example for wiring the fault alarm contacts. Wires are inserted into the fault alarm contacts.

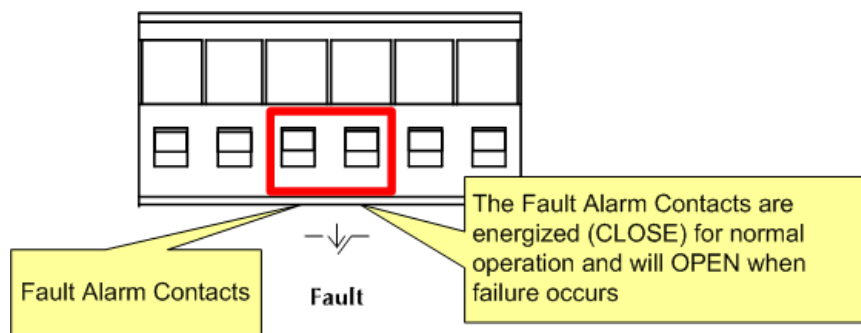
**Note:**

1. The wire gauge for the terminal block should be in the range of 12 to 24 AWG.
2. Alarm relay circuits accept up to 30 V, max. 3 A currents.

Product features

Physical port

- Eight 10/100BASE-T Fast Ethernet RJ45 copper ports with IEEE 802.3at/af PoE+ injector (port 1 to port 8).

- Two 10/100/1000BASE-T Gigabit Ethernet RJ45 ports (port 9 and port 10).
- Two 100/1000BASE-X mini-GBIC/SFP slots for SFP type auto detection (port 9 and port 10).

Power over Ethernet

- Complies with IEEE 802.3at Power over Ethernet Plus, end-span PSE.
- Backward compatible with IEEE 802.3af Power over Ethernet.
- Up to 8 ports of IEEE 802.3af/IEEE 802.3at devices powered.
- Supports PoE power up to 30 W for each PoE port.
- 240 W PoE budget
- Auto detects powered device (PD).
- Circuit protection prevents power interference between ports.
- Remote power feeding up to 100 meters.

Industrial case and installation

- IP30 aluminum case
- DIN-rail and wall-mount design
- 48 to 56 VDC redundant power with polarity reverse protect function.
- Supports Ethernet ESD protection for 6000 VDC
- -40 to 75°C operating temperature

Switching

- Hardware-based 10/100 Mbps (half/full duplex), 1000 Mbps (full duplex), auto-negotiation and auto MDI/MDI-X.
- Features Store-and-Forward mode with wire-speed filtering and forwarding rates.
- IEEE 802.3x flow control for full duplex operation and back pressure for half duplex operation.
- 16K MAC address table size
- 10K jumbo frame
- IEEE 802.1Q VLAN transparency
- Hardware DIP switch for “Standard” and “Extend” mode selection; the “Extend” mode features 30 W PoE transmit distance of 250 m at a speed of 10 Mbps.
- Automatic address learning and address aging
- Supports CSMA/CD protocol

Product specifications

Hardware Specifications	
Fast Ethernet Copper Ports	Eight 10/100BASE-TX RJ45 auto-MDI/MDI-X ports (port 1 to port 8)
Gigabit Ethernet Copper Ports	Two 10/100/1000BASE-T RJ45 auto-MDI/MDI-X ports (shared with port 9 and port 10)
SFP/mini-GBIC Slots	Two 1000BASE-SR/LX/BX SFP interfaces (shared with port 9 and port 10)
PoE Injector Port	Eight ports with 802.3af/802.3at PoE+ injector function (port 1 to port 8)
Switch Architecture	Store-and-Forward
Switch Fabric	5.6 Gbps / non-blocking
Throughput	4.1 Mpps @ 64 bytes
MAC Address Table	16K entries
Shared Data Buffer	4 Mbits
Flow Control	IEEE 802.3x pause frame for full-duplex Back pressure for half-duplex
Jumbo Frame	10K bytes
DIP Switch (Port 1 to Port 8)	Standard mode: 30 W PoE transmit distance of 100 m at speed of 10/100 Mbps. Extend mode: 30 W PoE transmit distance of 250 m at speed of 10 Mbps.
Enclosure	IP30 aluminum case
Installation	DIN rail kit and wall-mount kit
Connector	Removable 6-pin terminal block for power input. Pin 1/2 for Power 1 Pin 3/4 for fault alarm Pin 5/6 for Power 2
Alarm	One relay output for power failure. Alarm relay current carry ability: 1A @ 24 VDC
LED	System and power: DC power 1 (Green) DC power 2 (Green) Power fault Alarm (Red) PoE Copper Ports (Port 1 to Port 8): 10/100 Mbps LNK/ACT (Green) PoE-in-Use (Orange) 10/100/1000T Copper Ports (Port 9 to Port 10): LNK/ACT (Green) 1000 (Orange) Mini-GBIC Interface (Port 9 to Port 10): LNK/ACT (Green) 1000 (Orange)
Power Requirement	48 to 56 VDC, 5.5 A (max.), (>51 VDC for PoE+ output recommended)
Power	19 W, 64 BTU (Standby without PoE function) at DC 56 V power input.

Consumption/Dissipation	23 W, 78 BTU (Full loading without PoE function) at DC 56 V power input. 244 W, 832 BTU (Full loading with PoE function) at DC 56 V power input.
ESD Protection	6K VDC
Dimensions (W x D x H)	72 x 107 x 161 mm
Weight	1.034 kg
Power over Ethernet	
PoE Standard	IEEE 802.3at Power over Ethernet Plus/PSE
PoE Power Supply Type	End-span
PoE Power Output	IEEE 802.3af Standard Per port 48~51 VDC (depending on the power supply), max. 15.4 W. IEEE 802.3at Standard Per port 51~56 VDC (depending on the power supply), max. 30 W.
Power Pin Assignment	1/2(-), 3/6(+)
PoE Power Budget	Dual power input: 240 W maximum (depending on power input)
Max. Number of Class 2 PDs	8
Max. Number of Class 3 PDs	8
Max. Number of Class 4 PDs	8
Standards Conformance	
Regulation Compliance	FCC Part 15 Class A, CE
Stability Testing	IEC 60068-2-32 (free fall) IEC 60068-2-27 (shock) IEC 60068-2-6 (vibration)
Standards Compliance	IEEE 802.3 10BASE-T IEEE 802.3u 100BASE-TX IEEE 802.3ab Gigabit 1000BASE-T IEEE 802.3z Gigabit SX/LX IEEE 802.3x Flow Control and Back Pressure IEEE 802.3af Power over Ethernet IEEE 802.3at Power over Ethernet Plus
Environment	
Operating	Temperature: -40 to 75°C Relative Humidity: 5 to 95% (non-condensing)
Storage	Temperature: -40 to 85°C Relative Humidity: 5 to 95% (non-condensing)

Chapter 3

Installation

This section describes how to install and make connections to the industrial PoE+ switch. Read the following topics and perform the procedures in the order presented.

Note: The images in the following installation instructions are provided for reference. The device shown is not the industrial PoE+ switch.

DIN-rail mounting

There are two methods to install the industrial industrial PoE+ switch: DIN-rail mounting and wall-mount plate mounting. Please read the following topics and perform the procedures in the order presented.

Note: Follow all the DIN-rail installation steps as shown in the example.

To install the DIN rails on the industrial PoE+ switch:

1. Screw the DIN-rail onto the industrial PoE+ switch.



2. Carefully slide the DIN-rail into the track.



3. Ensure that the DIN-rail is tightly attached to the track.

To remove the industrial PoE+ switch from the track:

Carefully remove the DIN-rail from the track.



Wall mount plate mounting

Note: Follow all the wall mount plate installation steps as shown in the example.

To install the industrial PoE+ switch on the wall:

1. Remove the DIN-rail from the industrial PoE+ switch. Use the screwdriver to loosen the screws to remove the DIN-rail.
2. Place the wall-mount plate on the rear panel of the industrial PoE+ switch.

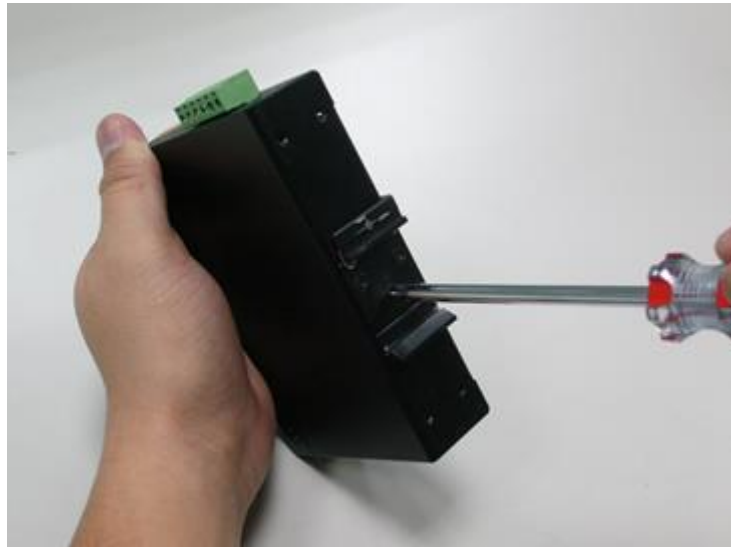

3. Use the screwdriver to screw the wall mount plate onto the industrial PoE+ switch.
4. Use the hook holes at the corners of the wall mount plate to hang the industrial PoE+ switch on the wall.
5. To remove the wall mount plate, reverse the steps above.

Installing the SFP transceiver

SFP transceivers are hot-pluggable and hot-swappable. They can be plugged in and removed to/from any SFP port without having to power down the industrial PoE+ switch (see below).



Before connecting to other network devices:

1. Make sure both sides of the SFP transceiver are with the same media type. For example, 1000BASE-SX to 1000BASE-SX, 1000BASE-LX to 1000BASE-LX.
2. Check if the fiber-optic cable type matches the SFP transceiver requirement.
 - To connect to 1000BASE-SX SFP transceiver, use the multi-mode fiber cable with one side being male duplex LC connector type.
 - To connect to 1000BASE-LX SFP transceiver, use the single-mode fiber cable with one side being male duplex LC connector type.

To connect the fiber cable:

1. Attach the duplex LC connector on the network cable to the SFP/SFP+ transceiver.
2. Connect the other end of the cable to a device with the SFP/SFP+ transceiver installed.
3. Check the LNK/ACT LED of the SFP/SFP+ slot on the front of the industrial PoE+ switch. Ensure that the SFP/SFP+ transceiver is operating correctly.
4. Check the link mode of the SFP port if the link fails.

Note: We recommend the use of Interlogix SFPs on the industrial PoE+ switch. If you insert an SFP transceiver that is not supported, the industrial PoE+ switch will not recognize it.

To remove the transceiver module:

1. Make sure there is no network activity by checking with the network administrator. Or, through the management interface of the switch/converter (if available), disable the port in advance.

2. Carefully remove the fiber optic cable.
3. Turn the lever of the transceiver module to a horizontal position.
4. Pull out the module gently through the lever.



Note: Never pull out the module without making use of the lever or the push bolts on the module. Removing the module with force could damage the module and the SFP/SFP+ module slot of the industrial PoE+ switch.

Chapter 4

Troubleshooting

This chapter contains information to help you solve issues. If the industrial PoE+ switch is not functioning properly, ensure that it was set up according to the instructions in this manual.

Issue	Solution
The link LED does not illuminate	Check the cable connection.
The industrial PoE+ switch doesn't connect to the network	<ol style="list-style-type: none">1. Check the LNK/ACT LED on the industrial PoE+ switch.2. Try another port on the industrial PoE+ switch.3. Make sure the cable is installed properly.4. Make sure the cable is the right type.5. Turn off the power. After a while, turn on power again.
The port link LED illuminates, but the traffic is irregular	Check that the attached device is not set to dedicated full duplex. Some devices use a physical or software switch to change duplex modes. Auto-negotiation may not recognize this type of full-duplex setting.
The industrial PoE+ switch doesn't connect to the network.	Check each port LED on the industrial PoE+ switch. Try another port. Make sure the cable is installed properly and the right type. Turn off the power. After a while, turn on the power again.
The industrial PoE+ switch does not power up.	<ol style="list-style-type: none">1. Check to ensure that the AC power cord is not faulty and that it is inserted properly.2. If the cord is inserted correctly, replace the power cord.3. Check that the AC power source is working by connecting a different device in place of the switch.4. If that device does not work, check the AC power

Appendix A

Networking connection

PoE RJ45 port pin assignments

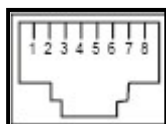

Pin Number	RJ45 Power Assignment
1	Power +
2	Power +
3	Power -
6	Power -

RJ45 port pin assignments – 1000Mbps, 1000BASE-T

Pin number	MDI	MDI-X
1	BI_DA+	BI_DB+
2	BI_DA-	BI_DB-
3	BI_DB+	BI_DA+
4	BI_DC+	BI_DD+
5	BI_DC-	BI_DD-
6	BI_DB-	BI_DA-
7	BI_DD+	BI_DC+
8	BI_DD-	BI_DC-

Implicit implementation of the crossover function within a twisted-pair cable, or at a wiring panel, while not expressly forbidden, is beyond the scope of this standard.

10/100Mbps, 10/100BASE-TX

When connecting the industrial PoE+ switch to another Fast Ethernet switch, a bridge, or a hub, a straight or crossover cable is necessary. Each port of the industrial PoE+ switch supports auto-MDI (Media Dependent Interface)/MDI-X (Media Dependent Interface Cross) detection. This makes it possible to directly connect the industrial PoE+ switch to any Ethernet device without making a crossover cable. The following table and diagram show the standard RJ45 receptacle/ connector and their pin assignments.

Pin number	MDI	MDI-X
1	Tx + (transmit)	Rx + (receive)
2	Tx - (transmit)	Rx - (receive)
3	Rx + (receive)	Tx + (transmit)
4, 5		Not used
6	Rx + (receive)	Tx + (transmit)
7, 8		Not used

The standard RJ45 receptacle/connector:

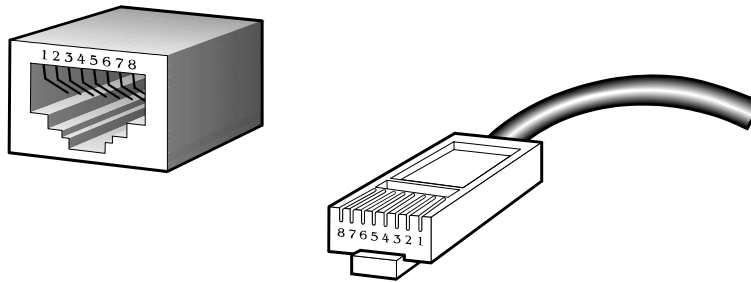

There are eight wires on a standard UTP/STP cable and each wire is color-coded. The following shows the pin allocation and the color of the straight cable and crossover cable connection:

Straight Cable		SIDE 1	SIDE 2
	SIDE 1	1 = White / Orange 2 = Orange 3 = White / Green 4 = Blue 5 = White / Blue 6 = Green 7 = White / Brown 8 = Brown	1 = White / Orange 2 = Orange 3 = White / Green 4 = Blue 5 = White / Blue 6 = Green 7 = White / Brown 8 = Brown
	SIDE 2		
Crossover Cable		SIDE 1	SIDE 2
	SIDE 1	1 = White / Orange 2 = Orange 3 = White / Green 4 = Blue 5 = White / Blue 6 = Green 7 = White / Brown 8 = Brown	1 = White / Green 2 = Green 3 = White / Orange 4 = Blue 5 = White / Blue 6 = Orange 7 = White / Brown 8 = Brown
	SIDE 2		

Ensure that connected cables are with the same pin assignment and color as the above diagram before deploying the cables into the network.

Fiber Optic cable connection parameters

The wiring details are shown below:

Standard	Fiber Type	Cable Specifications
1000BASE-SX (850 nm)	Multi-mode	50/125 μm or 62.5/125 μm
1000BASE-LX (1300 nm)	Multi-mode	50/125 μm or 62.5/125 μm
	Single-mode	9/125 μm

Wiring distances

Standard	Fiber	Diameter (micron)	Modal Bandwidth (MHz* km)	Max. Distance (meters)
1000BASE-SX	MM	62.5	100	220
		62.5	200	275
		50	400	500
		50	500	550
1000BASE-LX	MM	62.5	5	550
		50	4	
		50	5	
	SM	9	N/A	5000*

Appendix B

Approved Interlogix SFP transceivers

The following list of approved Interlogix SFP transceivers is valid as of the time of publication:

Part #	Fiber Connector	# of Fibers	Fiber Type	Max Distance	Wave Length	Optical Budget (dBm)	Optical Power (dBm)	Receiver Sensitivity (dBm)	Operating Temperature
Twisted Pair SFP 1000Base TX									
S30-RJ	RJ 45	1	Cat5e	100M (328 ft.)					0 to +50°C (32 to 122°F)
Fast Ethernet 100Base FX									
S20-2MLC2	LC	2	Multi-mode	2 km (1.2 mi.)	1310 nm	12	-20 ~ -14	-32	0 to +50°C (32 to 122°F)
S25-2MLC2	LC	2	Multi-mode	2 km (1.2 mi.)	1310 nm	12	-20 ~ -14	-32	-40 to +75°C (-40 to 167°F)
Fast Ethernet 100Base LX									
S20-2SLC20	LC	2	Single Mode	20 km (12 mi.)	1310 nm	19	-15 ~ -8	-34	0 to +50°C (32 to 122°F)
S25-2SLC20	LC	2	Single Mode	20 km (12 mi.)	1310 nm	19	-15 ~ -8	-34	-40 to +75°C (-40 to 167°F)
Fast Ethernet 100Base BX									
S20-1SLC/A-20	LC	1	Single Mode	20 km (12 mi.)	1310 / 1550 nm	18	-14 ~ -8	-32	0 to +50°C (32 to 122°F)
S25-1SLC/B-20	LC	1	Single Mode	20 km (12 mi.)	1550 / 1310 nm	18	-14 ~ -8	-32	-40 to +75°C (-40 to 167°F)
Gigabit Ethernet 1000Base SX									
S30-2MLC	LC	2	Multi-mode	220/550 m (720 / 1800 ft.)	850 nm	7.5	-9.5 ~ -1	-17	0 to +50°C (32 to 122°F)
S35-2MLC	LC	2	Multi-mode	220/550 m (720 / 1800 ft.)	850 nm	7.5	-14 ~ -8	-17	-40 to +75°C (-40 to 167°F)

OM1 Multimode fiber @ 200/500 MHz-km

Part #	Fiber Connector	# of Fibers	Fiber Type	Max Distance	Wave Length	Optical Budget (dBm)	Optical Power (dBm)	Receiver Sensitivity (dBm)	Operating Temperature
OM2 Multimode fiber @ 500.500 MHZ-km Laser Rated for GbE LANs									
S30-2MLC-2	LC	2	Multi-mode	2 km (1.2 mi.)	1310 nm	10	-9 ~ -1	-19	0 to +50°C (32 to 122°F)
OM3 Multimode fiber @ 2000/500MHz-km Optimized for 850 nm VCSELS									
Gigabit Ethernet 1000 Base LX									
S30-2SLC-10	LC	2	Single Mode	10 km (6.2 mi.)	1310 nm	18	-9.5 ~ -3	-20	0 to +50°C (32 to 122°F)
S35-2SLC-10	LC	2	Single Mode	10 km (6.2 mi.)	1310 nm	18	-9.5 ~ -3	-20	-40 to +75°C (-40 to 167°F)
S30-2SLC-30	LC	2	Single Mode	30 km (18.6 mi.)	1310 nm	18	-2 ~ +3	-23	0 to +50°C (32 to 122°F)
S35-2SLC-30	LC	2	Single Mode	30 km (18.6 mi.)	1310 nm	18	-2 ~ +3	-23	-40 to +75°C (-40 to 167°F)
Gigabit Ethernet 1000 Base ZX									
S30-2SLC-70	LC	2	Single Mode	70 km (43 mi.)	1550 nm	19*	-15 ~ -8	-34	0 to +50°C (32 to 122°F)
S35-2SLC-70	LC	2	Single Mode	70 km (43 mi.)	1550 nm	19*	-15 ~ -8	-34	-40 to +75°C (-40 to 167°F)
Gigabit Ethernet 1000 Base BX									
S30-1SLC/A-10	LC	1	Single Mode	10 km (6.2 mi.)	1310 / 1490 nm	11	-9 ~ -3	-20	0 to +50°C (32 to 122°F)
S30-1SLC/B-10	LC	1	Single Mode	10 km (6.2 mi.)	1490 / 1310 nm	11	-9 ~ -3	-20	0 to +50°C (32 to 122°F)
S30-1SLC/A-20	LC	1	Single Mode	20 km (12 mi.)	1310 / 1490 nm	15	-8 ~ -2	-23	0 to +50°C (32 to 122°F)
S30-1SLC/B-20	LC	1	Single Mode	20 km (12 mi.)	1490 / 1310 nm	15	-8 ~ -2	-23	0 to +50°C (32 to 122°F)
Gigabit Ethernet 1000 Base BX									
S30-1SLC/A-60	LC	1	Single Mode	60 km (37 mi.)	1310 / 1490 nm	24	0 ~ +5	-24	0 to +50°C (32 to 122°F)
S30-1SLC/B-60	LC	1	Single Mode	60 km (37 mi.)	1490 / 1310 nm	24	0 ~ +5	-24	0 to +50°C (32 to 122°F)

* Note: High Power Optic. There must be a minimum of 5 dB of optical loss to the fiber for proper operation.

Note: We recommend the use of Interlogix SFPs on the industrial PoE++ switch. If you insert an SFP transceiver that is not supported, the industrial PoE+ managed switch will not recognize it.

Note: Choose a SFP/SFP+ transceiver that can be operated under -40 to 75°C temperature if the industrial PoE+ switch is working in a 0 to 50°C temperature environment.