A large, thick black square graphic on the left side of the page, partially cut off by the edge.

TruVision HD-TVI 3MPX Camera Installation Guide

Contents

Introduction	2
Product overview	2
Installation	4
Installation environment	4
Package contents	5
Camera description	15
Mounting the TVI fixed lens bullet camera	20
Mounting the TVI VF motorized lens bullet camera	26
Mounting the TVI fixed lens turret camera	32
Mounting the TVI VF motorized lens turret camera	41
Specifications	50
Legal and regulatory information	52

Introduction

Product overview

This is the installation guide for TruVision 3MPX HD-TVI camera models:

HD-TVI fixed lens bullet camera:

- TVB-2407 (3MPX Bullet, 3.6 mm lens, PAL)
- TVB-4407 (3MPX Bullet, 3.6 mm lens, NTSC)

HD-TVI VF motorized lens bullet camera:

- TVB-2408 (3MPX Bullet, 2.8 to 12 mm lens, PAL)
- TVB-4408 (3MPX Bullet, 2.8 to 12 mm lens, NTSC)

HD-TVI fixed lens turret camera:

- TVT-2401 (3MPX Turret, 2.8 mm lens, PAL)
- TVT-4401 (3MPX Turret, 2.8 mm lens, NTSC)

HD-TVI VF motorized lens turret camera:

- TVT-2402 (3MPX Turret, 2.8 to 12 mm lens, PAL)
- TVT-4402 (3MPX Turret, 2.8 to 12 mm lens, NTSC)

Installation

This section provides information on how to install the cameras.

Installation environment

When installing your product, consider these factors:

- **Electrical:** Install electrical wiring carefully. It should be done by qualified service personnel. Always use a proper PoE switch or a 12 VDC UL listed Class 2 or CE certified power supply to power the camera. Do not overload the power cord or adapter.
- **Ventilation:** Ensure that the location planned for the installation of the camera is well ventilated.
- **Temperature:** Do not operate the camera beyond the specified temperature, humidity or power source ratings. The operating temperature of the camera is between -30 to +60°C (-22 to 140°F). Humidity is below 90%.

- **Moisture:** Do not expose the camera to rain or moisture, or try to operate it in wet areas. Turn the power off immediately if the camera is wet and ask a qualified service person for servicing. Moisture can damage the camera and also create the danger of electric shock.
- **Servicing:** Do not attempt to service this camera yourself. Any attempt to dismantle this product will invalidate the warranty and may also result in serious injury. Refer all servicing to qualified service personnel.
- **Cleaning:** Do not touch the sensor modules with fingers. If cleaning is necessary, use a clean cloth with some ethanol and wipe the camera gently. If the camera will not be used for an extended period of time, put on the lens cap to protect the sensors from dirt.

Package contents

Check the package and contents for visible damage. If any components are damaged or missing, do not attempt to use the unit; contact the supplier immediately. If the unit is returned, it must be shipped back in its original packaging.

HD-TVI fixed lens bullet camera

- Camera with power and video output cable harness (cables not shown)
- 3 screws (4 × 25 mm) and 3 anchors (7.5 × 24.5 mm)

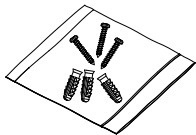
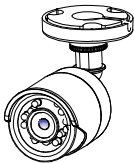

- Mounting template
- Installation guide

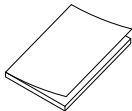
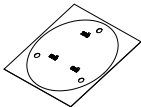

- 12 VDC connector:
Two terminal
connector with
positive and negative
indicators



- Torx wrench



- CD



- Equipment disposal
sheet

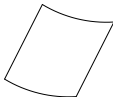

- Battery disposal sheet

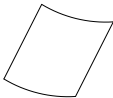

HD-TVI VF motorized lens bullet camera

- Camera with power and video output cable harness (cables not shown)
- 4 screws (4 × 25 mm) and 4 (7.5 × 24.5 mm) anchors

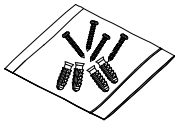
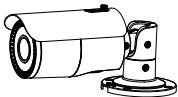

- Torx wrench

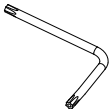

- Back box



- Video test cable



- 4 screws (M4.8 × 18). Used with the back box

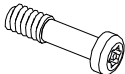

- Mounting template

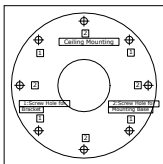

- Installation guide



- CD



- Equipment disposal sheet

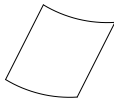

- Battery disposal sheet

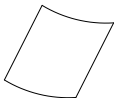

HD-TVI fixed lens turret camera

- Camera with power and video output cable harness (cables not shown)
- 3 screws (4 × 25 mm) and 3 anchors (7.5 × 24.5 mm)

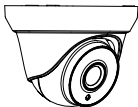

- 12 VDC connector: Two terminal connector with positive and negative indicators
- Mounting template

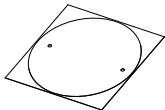

- Adapter plate

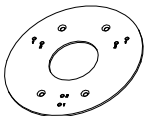

- 4 screws (PM6-32 x 10). Used to attach the turret camera to a 2 Gang electrical box

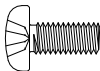

- 4 screws (KM4 x 8). Used to attach the turret camera to the bracket

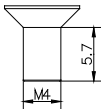

- 3 screws (PM4 x 8). Used to attach the turret camera to the adapter)

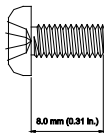

- CD



- Installation guide

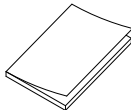

- Equipment disposal sheet

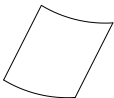

- Battery disposal sheet

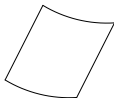

HD-TVI VF motorized lens turret camera

- Camera with power and video output cable harness

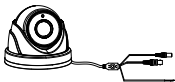

- 3 screws (4 × 25 mm) and 3 anchors (7.5 × 24.5 mm)

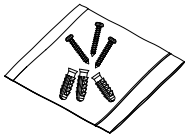

- Template

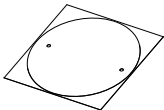

- Installation guide

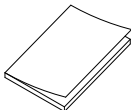

- 12 VDC connector:
Two-terminal
connector with positive
and negative indicators



- 4 screws (KM4 x 8).
Used to attach turret
camera to bracket



- 3 screws (PM4 x 8).
Used to attach the
turret camera to the
adapter)

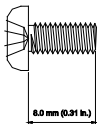

- Adapter plate

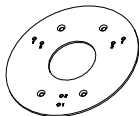

- 4 screws (PM6-32
x 10). Used to
attach the turret
camera to a 2 Gang
electrical box



- CD



- Equipment disposal sheet

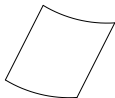

- Battery disposal sheet

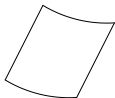

Camera description

Figure 1: HD-TVI fixed lens bullet camera

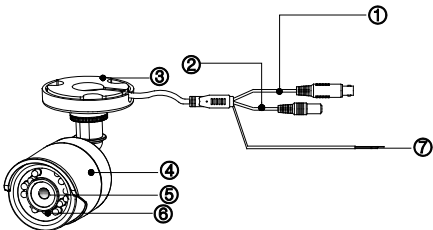

- | | |
|----------------------------------|--|
| 1. Selectable TVI or 960H output | 6. IR LEDs |
| 2. 12 VDC power | 7. HD-TVI (wires disconnected) / 960H (wires connected together) selection |
| 3. Mounting base | |
| 4. Camera body | |
| 5. Lens | |

Figure 2: HD-TVI VF motorized lens bullet camera

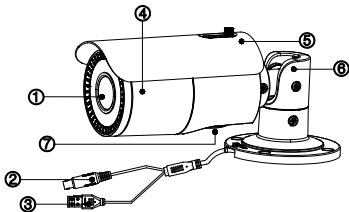

- | | |
|----------------------------------|---|
| 1. Lens | 5. Sunshield |
| 2. Selectable TVI or 960H output | 6. Mounting base |
| 3. 12 VDC/24 VAC power | 7. Access to 960H or TVI selection switch |
| 4. Camera body | |

Note: When making adjustments to the motorized lens bullet, it is important to make sure that the access cover for the area that contains the video test cable connector, OSD menu button, and the 960H/TVI selection switch is properly tightened to prevent leakage. The access cover should be rotated until it is tight, up against the camera body.

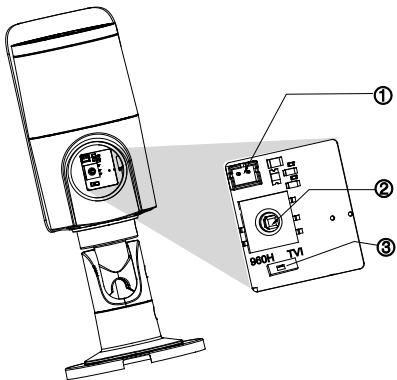

- | | |
|---------------------|------------------------------|
| 1. Video test cable | 3. 960H/TVI selection switch |
| 2. OSD menu button | |

Note: When making adjustments to the motorized lens bullet, it is important to make sure that the access cover for the area that contains the video test cable connector, OSD menu button, and the 960H/TVI selection switch is properly tightened to prevent leakage. The access cover should be rotated until it is tight, up against the camera body.

Figure 3: HD-TVI fixed lens turret camera

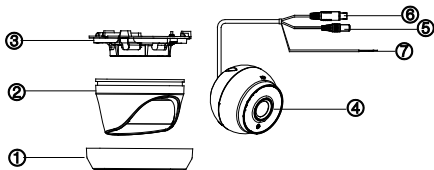

1. Trim ring
2. Housing
3. Base
4. Lens assembly
5. 12 VDC power
6. Selectable TVI or 960H output
7. HD-TVI (wires disconnected) / 960H (wires connected together) selection

Figure 4: HD-TVI VF motorized lens turret camera

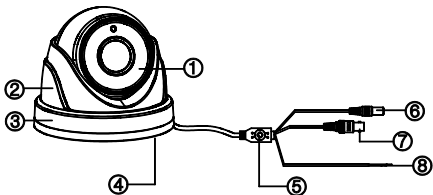

- | | |
|-----------------------------|--|
| 1. Lens assembly | 6. 12 VDC power |
| 2. Housing | 7. Selectable TVI or 960H output |
| 3. Trim ring | 8. HD-TVI (wires disconnected) / 960H (wires connected together) selection |
| 4. Base | |
| 5. OSD (5-direction) button | |

Mounting the HD-TVI fixed lens bullet camera

Surface mount

1. Place the provided template level against the mounting surface and mark the position of the mounting holes.

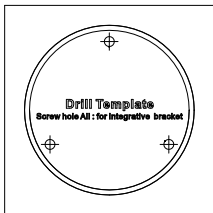

2. Following all local safety regulations, drill and prepare the mounting and cable access (if required) holes.
3. Route the cables through the cable access hole.
4. Secure the camera to the surface with the mounting hardware that was provided.

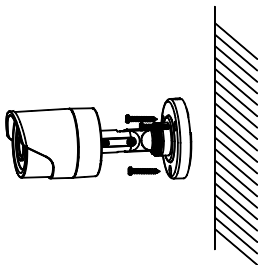

5. Connect the corresponding cables.
6. Adjust the camera to get the best viewing angle. See the figure below.

Pan position range: 0-360°

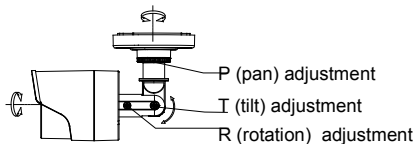

Rotation position
range: 360°

Tilt position range:
0-180°

- a) Loosen the P screw to adjust the pan direction [0-360°]. Tighten the screw after completing the adjustment.
 - b) Loosen the T screw to adjust the tilt direction [0-180°]. Tighten the screw after completing the adjustment.
 - c) Loosen the R screw and rotate the camera [0-360°] to adjust the lens to the desired surveillance angle. Tighten the screw after completing the adjustment.
7. Tighten the locking screws and the trim ring to position the camera in place.

Surface mount when using the optional back box

Note: Fixed lens bullet back box or 2 gang adapter plate are supplied separately.

1. Remove the cover from the back box and align the screw holes of the bullet camera with the holes in the back box cover.

2. Route the cables through the cable access hole of the back box. Mount the camera to the back box cover using the screws provided.

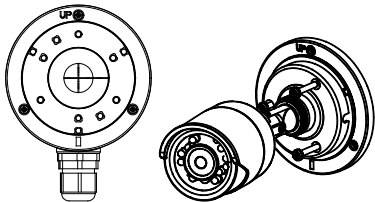

3. Place the mounting template level against the mounting surface and mark the position of the mounting holes. Use the 'UP' marking on the back box and camera mounting base as a reference.

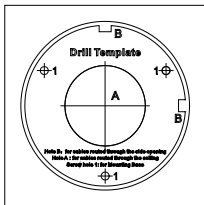

4. Following all local safety regulations, drill and prepare the mounting holes.
5. Install the back box to the mounting surface using the hardware provided.

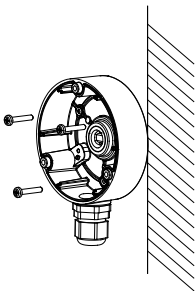

6. Connect the corresponding cables and install the back box cover and camera to the back box.

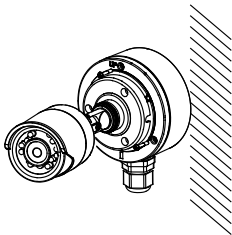

7. Refer to step 6 of “Surface mount” on page 20 to adjust the camera viewing angle.

Mounting the HD-TVI VF motorized lens bullet camera

Surface mount when using the optional back box

1. Place the provided template level against the mounting surface and mark the position of the mounting holes.

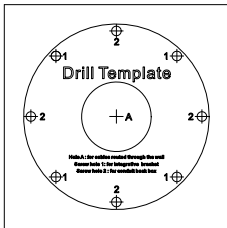

2. Following all local safety regulations, drill and prepare the mounting and cable access (if required) holes.
3. Route the cables through the cable access hole.

- Secure the camera to the mounting surface with the provided hardware.

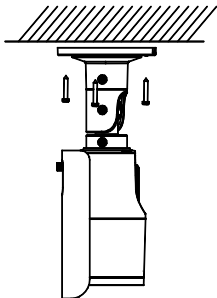

- Connect the corresponding cables.
- Adjust the camera to get the best viewing angle. See the figure below.

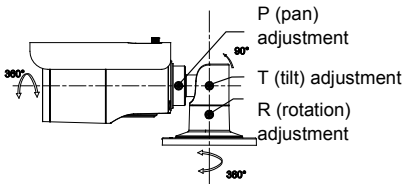

- a) Loosen the P screw to adjust the pan direction [0-360°]. Tighten the screw after completing the adjustment.
- b) Loosen the T screw to adjust the tilt direction [0-180°]. Tighten the screw after completing the adjustment.
- c) Loosen the R screw and rotate the camera [0-360°] to adjust the lens to the desired surveillance angle. Tighten the screw after completing the adjustment.

Surface mount when using the optional back box

1. Remove the cover from the back box and align the screw holes of the bullet camera with the holes in the back box cover.
2. Route the cables through the cable access hole of the back box. Install the camera to the back box cover using the screws provided. See figure below.

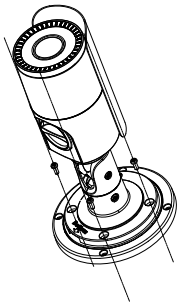

- Place the provided template level against the mounting surface and mark the position of the mounting holes.

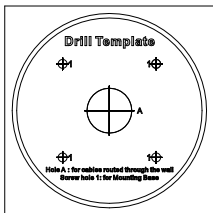

- Following all local safety regulations, drill and prepare the mounting holes.
- Install the back box to the mounting surface using the hardware provided.

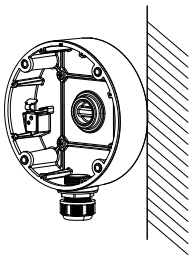

6. Connect the corresponding cables and install the back box cover with camera to the back box.

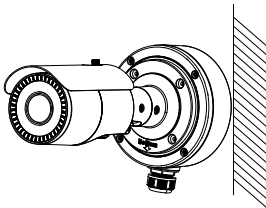

7. Refer to step 6 of “Surface mount” on page 28 to adjust the camera to the desired viewing angle.

Mounting the HD-TVI fixed lens turret camera

Surface mount

1. Disassemble the turret camera by rotating the trim ring, as shown below.

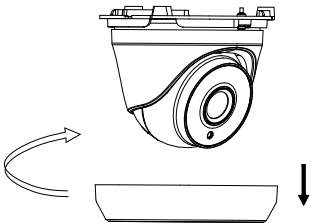

2. Place the provided template level against the mounting surface and mark the position of the mounting holes.

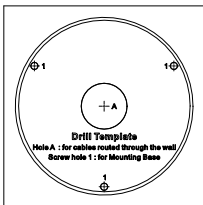

3. Following all local safety regulations, drill and prepare the mounting and cable holes.
4. Route the cables through the cable access (if required) hole.
5. Secure the mounting base to the mounting surface with the hardware provided.

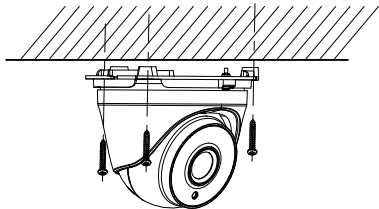

6. Route the cables. Connect the power cord and TVI cables.
7. Reassemble the turret camera by rotating the trim ring back in place.

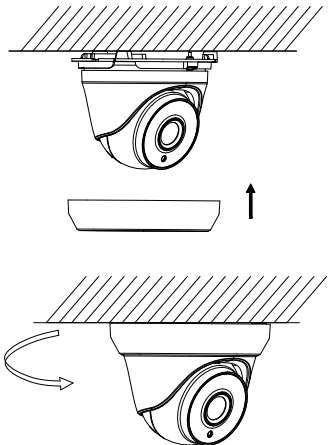

If installing the turret camera to a wall mount or other accessory, an adapter plate is provided.

Install the adapter plate to the accessory with three PM4 x 8 screws, referencing number "2".

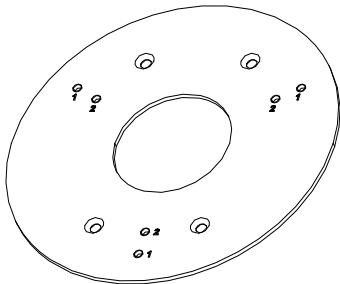

8. Adjust the camera to get the best viewing angle. See figure below.

Pan position range: 0-360°

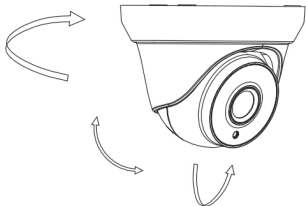

Tilt position range:
0-75°

Rotation position
range: 0-360°

- a) Hold the camera body and rotate the enclosure to adjust the pan angle [0- 360°].
- b) Move the camera body up and down to adjust the tilt angle [0-75°].
- c) Rotate the camera body to adjust the azimuth angle [0-360°].

Surface mount when using the optional back box

1. Disassemble the turret camera by rotating the trim ring, as shown below.

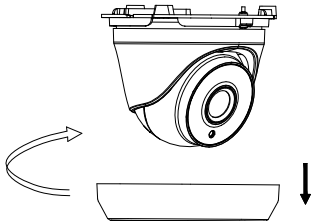

2. Remove the cover from the back box.
3. Place the provided template level against the mounting surface and mark the position of the mounting holes.
4. Following all local safety regulations, drill and prepare the mounting holes.

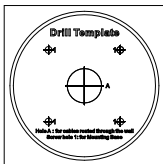

5. Route the cables through the cable access hole of the back box. Mount the camera to the cover of the back box.

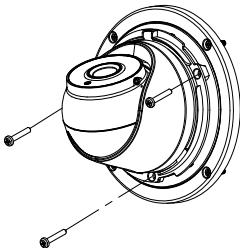

6. Mount the back box to the mounting surface.

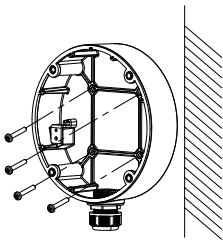

7. Connect the corresponding cables and install the back box cover, with camera, to the back box.

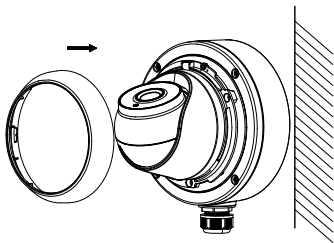

8. Rotate the trim ring back on to the camera, as shown below.

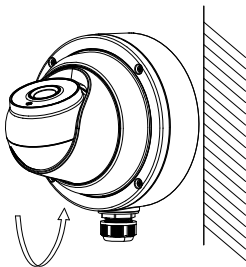

9. Refer to step 8 of “Surface mount” on page 32 to adjust the camera to the desired viewing angle.

Mounting the HD-TVI VF motorized lens turret camera

Surface mount

1. Place the provided template level against the mounting surface and mark the position of the mounting holes.
2. Following all local safety regulations, drill and prepare the mounting holes.
3. Disassemble the turret camera by rotating the trim ring counterclockwise, as shown below.

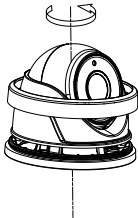

4. Route the cables through the cable access (if required) hole.

5. Secure the mounting base to the surface using the screws provided.

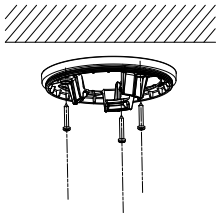

If installing the turret camera to a wall mount or other accessory, an adapter plate is provided. Install the adapter plate to the accessory with three PM4 x 8 screws, referencing number "2".

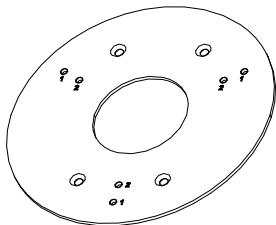

6. Reassemble the turret camera by rotating the trim ring back on the camera, as shown below.

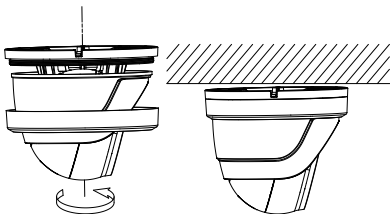

Helpful hints when mounting the turret camera:

- a) Mount the turret base to a surface.

- b) When mounting on a wall, aim the lens towards the floor and the UP marking on the camera assembly towards the ceiling.
 - c) Place the camera eyeball assembly on two of the three standoffs of the mounting base.
 - d) Place the turret housing over the camera assembly.
 - e) Place the metal ring over the camera turret housing.
 - f) Hold the turret housing and camera assembly in place with your right hand.
 - g) Using your left hand, rotate the metal ring clockwise to tighten it.
 - h) Prior to completely tightening the ring, aim the camera body/lens towards the desired position.
7. Adjust the camera to get the best viewing angle (see figures below).

- a) Hold the camera body and rotate the enclosure to adjust the pan angle [0- 360°].
- b) Move the camera body up and down to adjust the tilt angle [0-75°].
- c) Rotate the camera body to adjust the azimuth angle [0-360°].

Pan position range:
0-360°

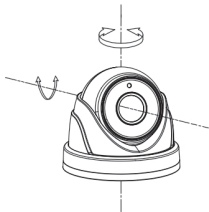

Tilt position range:
0-75°



Rotation position range: 0-360°

Surface mount when using the optional back box

1. Remove the cover from the back box.

- Place the provided template level against the mounting surface and mark the position of the mounting holes.

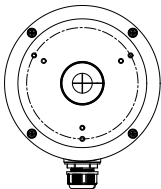
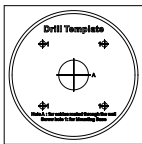

- Following all local safety regulations, drill and prepare the mounting holes.
- Disassemble the turret camera by rotating the trim ring counterclockwise, as shown below.

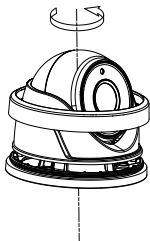

5. Route the cables through the cable access hole of the back box. Mount the camera to the back box.

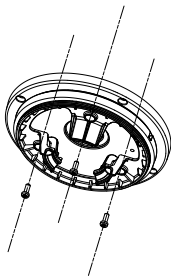

6. Install the back box to the mounting surface using the hardware provided.

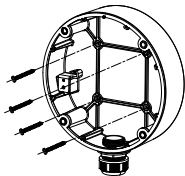

7. Connect the corresponding cables and install the back box cover and camera to the back box.

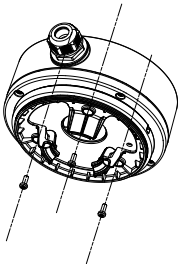

8. Rotate the trim ring back on to the camera body, as shown by the arrow.

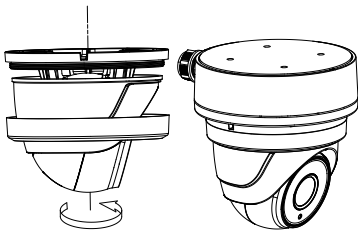

9. Adjust the camera according to step 8 of “Surface mount” on page 37 to get the best viewing angle.

Specifications

Power supply	12 VDC / 24 VAC
Current	TVB-2407 / TVB-4407: 12 VDC: Max. 417 mA TVB-2408/TVB-4408: 12 VDC: Max. 750 mA / 24 VAC: Max. 400 mA TVT-2401/TVT-4401: 12 VDC: Max. 417 mA TVT-2402/TVT-4402: 12 VDC: Max. 550 mA
Power consumption	TVB-2407/TVB-4407: 12 VDC: Max. 5 W TVB-2408/TVB-4408: 12 VDC: Max. 9 W / 24 VAC: 12 W TVT-2401/TVT-4401: 12 VDC: Max. 5 W TVT-2402/TVT-4402: 12 VDC: Max. 6 W

Weight (net)	<p>TVB-2407/TVB-4407: 370 g / 0.82 lb.</p> <p>TVB-2408/TVB-4408: 900 g / 1.98 lb.</p> <p>TVT-2401/TVT-4401: 350 g / 0.77 lb.</p> <p>TVT-2402/TVT-4402: 750 g / 1.57 lb.</p>
Dimensions	<hr/> <p>TVB-2407/TVB-4407: 58.2 × 154.5 mm / 2.3 × 6.08 in.</p> <p>TVB-2408/TVB-4408: 94.7 × 265.4 mm / 3.7 × 10.45 in.</p> <p>TVT-2401/TVT-4401: 226.7 × 97.84 mm / 5 × 3.85 in.</p> <p>TVT-2402/TVT-4402: 135.78 × 118.2 mm / 5.35 × 4.65 in.</p> <hr/>

Legal and regulatory information

Copyright:

© 2017 United Technologies Corporation. All rights reserved.
Interlogix is part of UTC Climate, Controls & Security, a unit of United Technologies Corporation.

Trademarks and patents:

Trade names used in this document may be trademarks or registered trademarks of the manufacturers or vendors of the respective products.

Manufacturer:

Interlogix
2955 Red Hill Avenue, Costa Mesa, CA 92626-5923, USA
Authorized EU manufacturing representative:
UTC Fire & Security B.V.
Kelvinstraat 7, 6003 DH Weert, The Netherlands

Certification:



FCC compliance: Class A

Class A: This equipment has been tested and found to comply with the limits for a Class A digital device, pursuant to part 15 of the FCC Rules. These limits are designed to provide reasonable protection against harmful interference when the equipment is operated in a commercial environment. This equipment generates, uses, and can radiate radio frequency energy and, if not installed

and used in accordance with the instruction manual, may cause harmful interference to radio communications. Operation of this equipment in a residential area is likely to cause harmful interference in which case the user will be required to correct the interference at his own expense.

FCC conditions:

This device complies with Part 15 of the FCC Rules. Operation is subject to the following two conditions:

- (1) This device may not cause harmful interference.
- (2) This Device must accept any interference received, including interference that may cause undesired operation.

ACMA compliance:

Notice! This is a Class A product. In a domestic environment this product may cause radio interference in which case the user may be required to take adequate measures.

Canada:

This Class A digital apparatus complies with CAN ICES-003 (A)/NMB-3 (A).

Cet appareil numérique de la classe A est conforme à la norme CAN ICES-003 (A)/NMB-3 (A).

European Union directives:

This product and - if applicable - the supplied accessories too are marked with "CE" and comply therefore with the applicable harmonized European standards listed under the EMC Directive 2014/30/EU, the RoHS Directive 2011/65/EU.



2012/19/EU (WEEE directive): Products marked with this symbol cannot be disposed of as unsorted municipal waste in the European Union. For proper recycling, return this product to your local supplier upon the purchase of equivalent new equipment, or dispose of it at designated collection points. For more information see: www.recyclethis.info.

Contact information:

For contact information, see www.interlogix.com or www.utcssecurityproducts.eu

