

A large, thick, black square graphic on the left side of the page, partially cut off by the edge.

TruVision Series 4 IP Camera Installation Guide

P/N 1073195-EN • REV D • ISS 24AUG16

Copyright	© 2016 United Technologies Corporation, Interlogix is part of UTC Climate, Controls & Security, a unit of United Technologies Corporation. All rights reserved.
Trademarks and patents	Trade names used in this document may be trademarks or registered trademarks of the manufacturers or vendors of the respective products.
Manufacturer	Interlogix 2955 Red Hill Avenue, Costa Mesa, CA 92626-5923, USA Authorized EU manufacturing representative: UTC Fire & Security B.V. Kelvinstraat 7, 6003 DH Weert, The Netherlands
Certification	  
FCC compliance	<p>Class A: This equipment has been tested and found to comply with the limits for a Class A digital device, pursuant to part 15 of the FCC Rules. These limits are designed to provide reasonable protection against harmful interference when the equipment is operated in a commercial environment. This equipment generates, uses, and can radiate radio frequency energy and, if not installed and used in accordance with the instruction manual, may cause harmful interference to radio communications. Operation of this equipment in a residential area is likely to cause harmful interference in which case the user will be required to correct the interference at his own expense.</p>
FCC conditions	<p>This device complies with Part 15 of the FCC Rules. Operation is subject to the following two conditions:</p> <p>(1) This device may not cause harmful</p>

interference.

(2) This Device must accept any interference received, including interference that may cause undesired operation.

ACMA compliance **Notice!** This is a Class A product. In a domestic environment this product may cause radio interference in which case the user may be required to take adequate measures.

Canada This Class A digital apparatus complies with CAN ICES-003 (A)/NMB-3 (A).

Cet appareil numérique de la classe A est conforme à la norme CAN ICES-003 (A)/NMB-3 (A).

European Union directives This product and - if applicable - the supplied accessories too are marked with "CE" and comply therefore with the applicable harmonized European standards listed under the EMC Directive 2014/30/EU, the RoHS Directive 2011/65/EU.



2012/19/EU (WEEE directive): Products marked with this symbol cannot be disposed of as unsorted municipal waste in the European Union. For proper recycling, return this product to your local supplier upon the purchase of equivalent new equipment, or dispose of it at designated collection points. For more information see: www.recyclethis.info.



2013/56/EU & 2006/66/EC (battery directive): This product contains a battery that cannot be disposed of as unsorted municipal waste in the European Union. See the product documentation for specific battery information. The battery is marked with this symbol, which may include lettering to indicate cadmium (Cd), lead (Pb), or mercury (Hg). For proper recycling, return the battery to your supplier or to a designated collection point. For more

information see: www.recyclethis.info.

Contact information For contact information, see www.interlogix.com or www.utcssecurityproducts.eu.

Content

Introduction 2

Product overview 2

Installation 3

Installation environment 3

Package contents 4

Cable requirements 10

Camera description 11

Setting up the camera 15

IR illuminators 16

Accessing the SD card 17

Mounting the bullet camera 17

Mounting the VF mini dome camera 18

Mounting the outdoor dome camera 24

Using the camera with a TruVision recorder or another system 29

Using the camera with TruVision Navigator 29

Specifications 29

TruVision IP box cameras 29

TruVision IP VF bullet dome 30

TruVision IP VF mini cameras 30

TruVision IP VF outdoor dome cameras 31

Pin definitions 32

Introduction

Product overview

This is the installation guide for TruVision Series 4 IP camera models:

- TVC-5401 (2MPX IP box camera)
- TVC-5402 (3MPX IP box camera)
- TVC-5403 (5MPX IP box camera)

- TVB-5401 (2MPX IP bullet camera, 2.8 to 12 mm)
- TVB-5402 (2MPX IP bullet camera, 8 to 32 mm)
- TVB-5403 (3MPX IP bullet camera, 2.8 to 12 mm)
- TVB-5404 (3MPX IP bullet camera, 8 to 32 mm)
- TVB-5405 (5MPX IP bullet camera, 2.8 to 12 mm)

- TVD-5401 (2MPX IP VF mini dome, 2.8 to 12 mm)
- TVD-5402 (3MPX IP VF mini dome, 2.8 to 12 mm)
- TVD-5403 (5MPX IP VF mini dome, 2.8 to 12 mm)
- TVD-5404 (2MPX IP outdoor dome, 2.8 to 12 mm)
- TVD-5405 (2MPX IP outdoor dome, 8 to 32 mm)
- TVD-5406 (3MPX IP outdoor dome, 2.8 to 12 mm)
- TVD-5407 (3MPX IP outdoor dome, 8 to 32 mm)
- TVD-5408 (5MPX IP outdoor dome, 2.8 to 12 mm)

Installation

This section provides information on how to install the cameras.

Installation environment

When installing your product, consider these factors:

- **Electrical:** Install electrical wiring carefully. It should be done by qualified service personnel. Always use a proper PoE switch or a 12 VDC UL listed Class 2 or CE certified power supply to power the camera. Do not overload the power cord or adapter.
- **Ventilation:** Ensure that the location planned for the installation of the camera is well ventilated.
- **Temperature:** Do not operate the camera beyond the specified temperature, humidity or power source ratings. The operating temperature of the camera without heater is between -30 to +60°C (-22 to 140°F). Humidity is below 90%. For the outdoor cameras that feature built-in heaters, the operating temperature range is -40 to 60°C (-40 to 140°F)
- **Moisture:** Do not expose the camera to rain or moisture or try to operate it in wet areas. Turn the power off immediately if the camera is wet and ask a qualified service person for servicing. Moisture can damage the camera and also create the danger of electric shock.
- **Servicing:** Do not attempt to service this camera yourself. Any attempt to dismantle or remove the covers from this product will invalidate the warranty and may also result in serious injury. Refer all servicing to qualified service personnel.

- **Cleaning:** Do not touch the sensor modules with fingers. If cleaning is necessary, use a clean cloth with some ethanol and wipe the camera gently. If the camera will not be used for an extended period of time, put on the lens cap to protect the sensors from dirt.

Package contents

Check the package and contents for visible damage. If any components are damaged or missing, do not attempt to use the unit; contact the supplier immediately. If the unit is returned, it must be shipped back in its original packaging.

IP box camera

- Camera

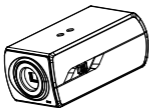

- C-CS adaptor



- CD with Configuration manual and TruVision Device Manager

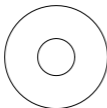

- Installation manual

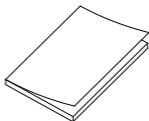

- WEEE and Battery Disposal sheets

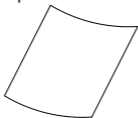

IP VF bullet camera

- Camera



- Back box



- Template

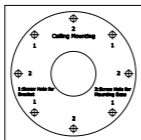

- Screws M4.8 × 18 (4 pcs) to attach the back box



- Screws (4 pcs)

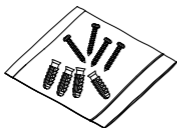

- Water joint: Provide water resistance to network connection.

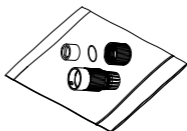

- CD with Configuration manual and TruVision Device Manager

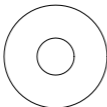

- Installation manual

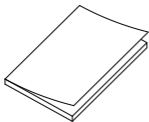

- Wrench

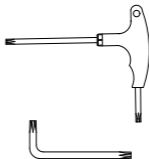

- WEEE and Battery Disposal sheets

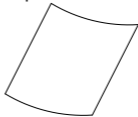

IP VF mini dome camera

- Camera

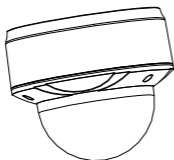

- Adaptor: for TVD-CB3 cup base

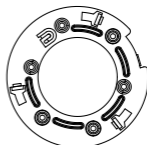

- Template

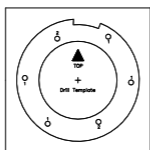

- Screws (4 pcs)



- Hex wrench



- CD with Configuration manual and TruVision Device Manager

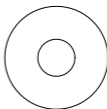

- Installation manual



- WEEE and Battery Disposal sheets

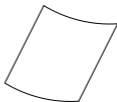

IP VF outdoor dome camera

- Camera

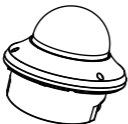

- Back box

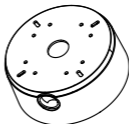

- Template (flush mount)

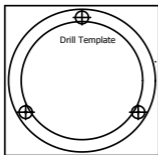

- Template (back box)

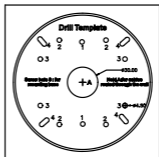

- Screws (4 pcs)



- Screws: 4 × 75 mm (3 pcs)

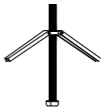

- Screws M4 × 9.5 (3 pcs) to attach the back box



- Alarm connector (4 pcs)

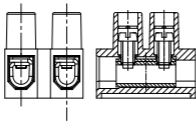

- Installation manual



- WEEE and Battery Disposal sheets

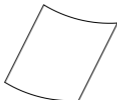

- Wrench



- Water joint: Provide water resistance to network connection.

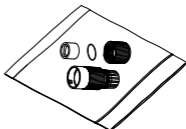

- CD with Configuration manual and TruVision Device Manager

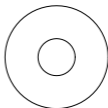

- G 3/4 conduit



CAUTION: Use direct plug-in UL listed power supplies marked Class 2/CE certified or LPS (limited power source) of the required output rating as listed on the unit.

CAUTION: Risk of explosion if the battery is replaced by an incorrect type. Dispose of used batteries according to the instructions.

Cable requirements

For proper operation, adhere to the following cable and power requirements for the cameras. Category 5 cabling or better is recommended. All network cabling must be installed according to applicable codes and regulations.

Table 1 below lists the requirements for the cables that connect to the camera.

Table 1: Recommended power cable requirements

Box camera:	12 VDC/24 VAC power wires or PoE (802.3af)
VF bullet camera:	12 VDC power wires or PoE+ (802.3at)
VF mini dome:	12 VDC power wires or PoE (802.3af)
VF outdoor dome:	12 VDC/24 VAC power wires or PoE+ (802.3at)

Camera description

Figure 1: IP bullet camera

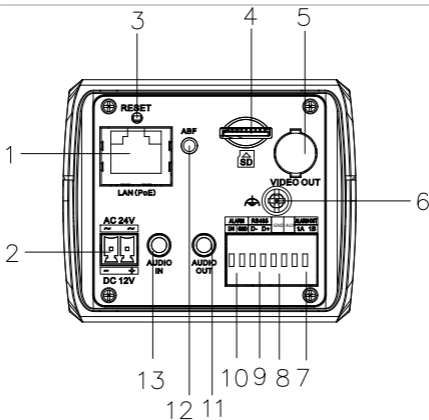

- | | |
|---------------------------|---------------------------------------|
| 1. Ethernet RJ45 PoE port | 8. Aux Power Port (AUX&GND) |
| 2. Power supply | 9. RS-485 port |
| 3. Reset button | 10. Alarm In |
| 4. SD card slot | 11. Audio Out |
| 5. BNC port | 12. ABF (automatic back focus) button |
| 6. Ground | 13. Audio In |
| 7. Alarm Out | |

Note:

1. To reset the camera to default settings, press and hold the RESET button and power on the camera. After the camera is started up, please hold the Reset button for an additional 20 seconds.
2. The type of auto-iris interface is shown below:

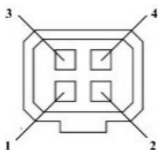

No.	DC-driven
1	Damp-
2	Damp+
3	Drive+
4	Drive-

Power, Video and GND pins are used when the auto-iris is driven by video. Damp+, Damp-, Drive+ and Drive- pins are used when the auto-iris is driven by DC.

Figure 2: IP VF bullet camera

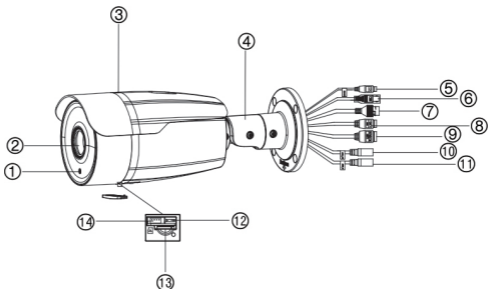

- | | |
|---------------------------|------------------|
| 1. Light sensor | 8. Power supply |
| 2. Lens | 9. Alarm I/O |
| 3. Shield | 10. Audio output |
| 4. Mounting base | 11. Audio input |
| 5. DC 12V output | 12. Reset button |
| 6. BNC output | 13. SD card slot |
| 7. Ethernet RJ45 PoE port | 14. Serial port |

Figure 3: IP VF mini dome camera

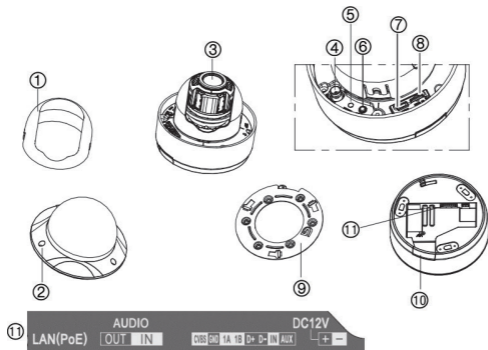

1. Dome liner
2. Bubble Assembly
3. Lens
4. BNC port
5. Reset button
6. Status indicator
7. Serial port
8. SD card slot
9. Adaptor
10. Knockout
11. Camera terminals

Figure 4: IP VF outdoor dome camera

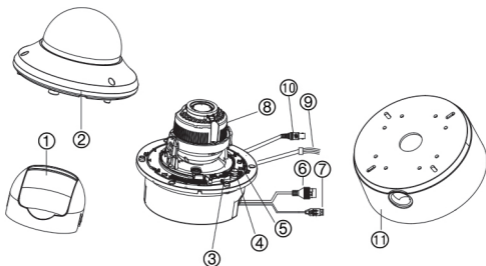

- | | |
|---------------------------|---|
| 1. Dome liner | 7. Power supply |
| 2. Bubble Assembly | 8. Lens |
| 3. SD card slot | 9. Alarm I/O, 12 V AUX output and Audio I/O |
| 4. Video output | 10. BNC output |
| 5. Reset button | 11. Back box |
| 6. Ethernet RJ45 PoE port | |

Setting up the camera

Note: If the light source where the camera is installed experiences rapid, wide-variations in lighting, the camera may not operate as intended.

To quickly put the camera into operation:

1. Prepare the mounting surface.
2. Mount the camera on the mounting surface using the appropriate fasteners. See “Mounting the bullet camera” on page 17.
3. Set up the camera’s network and streaming parameters so that the camera can be controlled over the network. For further information, please refer to the “TruVision Series 4 IP Camera Configuration Manual”.
4. Program the camera as appropriate for its location. For further information, please refer to the “TruVision Series 4 IP Camera Configuration Manual”.

IR illuminators

The camera’s built-in IR illumination provides high-quality video in low-light environments, even when there is no other illumination available.

You can configure the IR illumination using a web browser or a client software, such as TruVision Navigator. If the function is enabled, the IR light is On when the camera enters night (black and white) mode. If disabled, the IR light is always Off.

The visible IR range may vary due to multiple factors such as weather, IR reflection level of objects in frame, lens adjustment, and camera settings. Please refer to the camera datasheet for the standard IR range.

Note: Avoid installing the IR camera closely facing a solid object such as a tree or wall. The reflection will cause over-exposure and loss of visibility of detail in field of view.

Accessing the SD card

Insert a Micro SD card with up to 128GB to use the camera as an additional recording device, or as a backup in case of failure of communication with the network video recorder (see Figure 1 on page 11). The card is not supplied with the camera.

For the IP VF mini dome and outdoor dome cameras, point the lens vertically upwards to access the SD card slot.

Recorded video and log files can be accessed via the web browser or via TruVision Navigator.

Mounting the bullet camera

Mount the camera on a ceiling or wall.

To mount the bullet camera:

1. Use the supplied template to mark out the mounting area. Drill the screw holes on the ceiling or wall. If you need to route the cables from the camera base, drill a cable hole in the ceiling or wall.
2. Secure the back box to the ceiling or wall with the supplied screws.

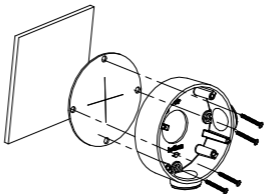

- Hook the camera to the back box with the safety cable.
Use the screws to fix the camera to the back box.

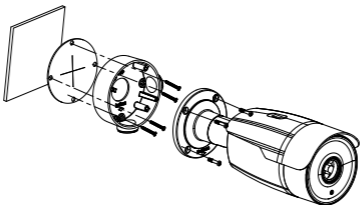

Mounting the VF mini dome camera

To mount the VF dome camera on a ceiling or wall:

- Loosen the three screws on the edge of the lower dome with a wrench.

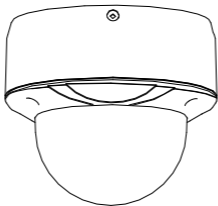

- Open the lower dome and remove the black inner liner.

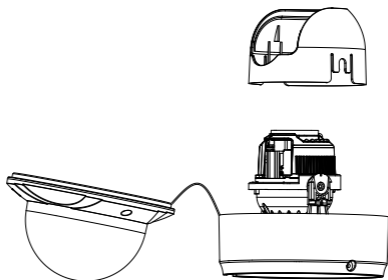

3. Using the drill template, drill the holes in the mounting surface.

Screw holes

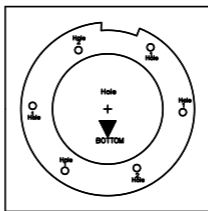

Cable holes

4. If you want to route the cables behind the dome, drill a cable hole in the ceiling or wall using the drill template.

(Optional) Routing the cable from the side knockout instead of the cable hole drilled on the ceiling is

supported. Use a pliers to remove the knockout plug shown in the figure below, and route the cables from the knockout.

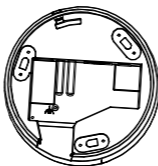

Knockout

5. Fix the adapter plate to the ceiling with the supplied screws.

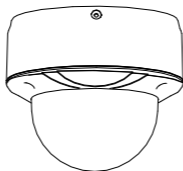
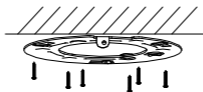

6. Align the mounting base with the adapter plate and route the mounting base counterclockwise to fit it to the adapter plate. Then secure it by tightening the lock screw.

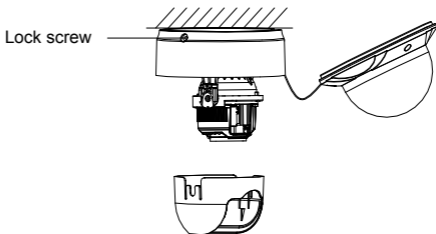

7. Adjust the viewing angle according to the figure below. Panning angle [0~80°], tilting angle [0~355°], and azimuth angle of the lens [0~355°].

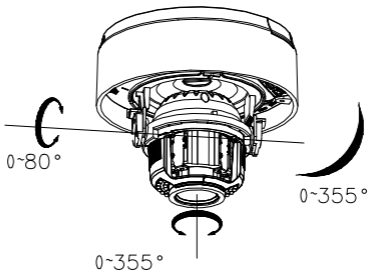

8. Adjust the focus and zoom.
- Connect the VIDEO OUT interface of the camera to the event monitor.
 - Set the iris type to MANUAL.

- c) Adjust the No.1 Zoom Lever (T~W) to select a proper angle of view.
- d) Adjust the No.2 Focus Lever (F~N) to obtain the desired image quality on the monitor.
- e) Set the iris type as MANUAL if the environment has a good and stable illumination. Set the iris type as AUTO if the environment has varied levels of illumination.

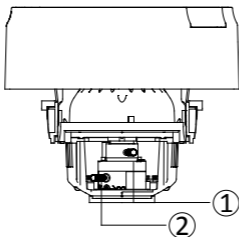

- 9. Attach the black liner to the dome drive.
- 10. Attach the bubble to the dome drive and rotate it to tighten.

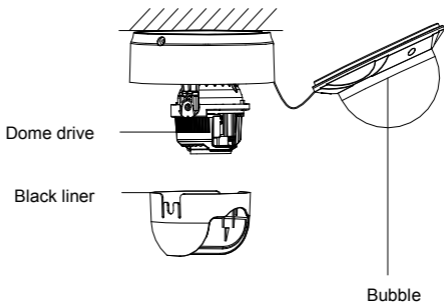

11. Tighten the lock screw to complete the installation.

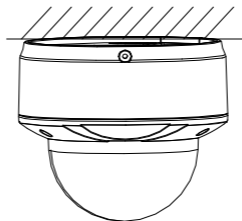

Mounting the outdoor dome camera

To mount the outdoor dome camera on a ceiling:

1. Drill the screw holes on the ceiling with the supplied drilling template. To route the cables from the base of the camera, cut a cable hole in the ceiling.

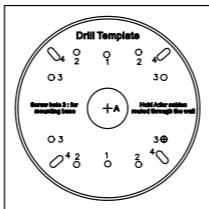

2. Install the mounting base to the ceiling with the supplied screws.

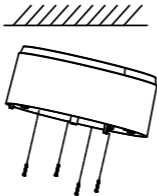

3. Connect the corresponding power cable and network cables.
4. Remove the bubble and liner of the camera.



5. Install the dome camera to the mounting base.

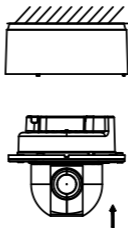

6. Adjust the viewing angle.
- a) Loosen the lock screw beside the lens.
 - b) Hold the plastic plate and rotate the camera to adjust the panning angle [0~350°].
 - c) Push the lens forward and backward to adjust the tilting angle [0~80°].

- d) Rotate the lens to adjust the azimuth angle of the camera [0~350°].
- e) Tighten the lock screw.

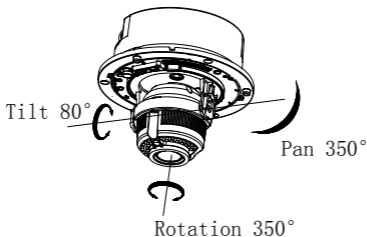

7. Re-attach the dome liner and bubble to the camera.

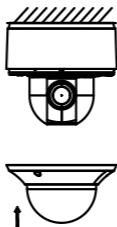

To mount the outdoor dome camera into a ceiling:

1. Drill the screw holes on the ceiling with the supplied drilling template.

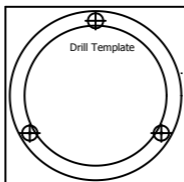

2. Remove the housing and liner from the camera.

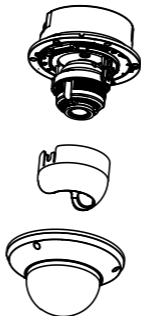

3. Secure the camera to the holes with three screws.

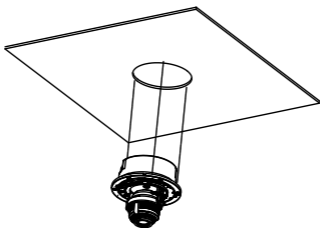

4. Re-attach the housing and liner.

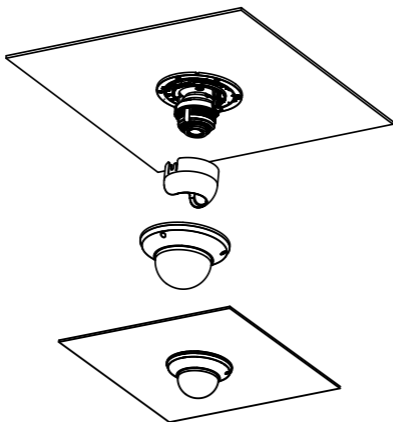

Using the camera with a TruVision recorder or another system

Please refer to the NVR/DVR user manuals for instructions on connecting and operating the camera with these systems.

Using the camera with TruVision Navigator

A camera can either be connected to a TruVision, or it can be added directly to TruVision Navigator. Please refer to the TruVision Navigator user manual for instructions on operating the camera with TruVision Navigator.

Specifications

TruVision IP box cameras

Electrical

Voltage input	12 VDC/24 VAC, PoE (IEEE 802.3af)
---------------	-----------------------------------

Power consumption	Max. 10 W
-------------------	-----------

Miscellaneous

Connectors	AC/DC Power, Network, Audio, Alarm In/Out and Video
------------	---

Operating temperature	-30 to +60 °C (-22 to +140°F)
-----------------------	-------------------------------

Dimensions	69.8 × 58 × 145 mm (2.75 x 2.28 x 5.71 in.)
------------	--

Weight	830 g (1.83 lbs.)
--------	-------------------

TruVision IP VF bullet dome

Electrical

Voltage input	12 VDC, PoE+ (IEEE 802.3at)
---------------	-----------------------------

Power consumption	Max. 13 W
-------------------	-----------

Miscellaneous

Connectors	Audio In/Out, Alarm In/Out, 12 VDC Power Input, Network Port (PoE), CVBS Output, AUX Power Output
------------	---

Operating temperature	-40 to +60 °C (-40 to +140 °F)
-----------------------	--------------------------------

Dimensions	Ø 115.8 × 291.8 mm (Ø 4.56 × 11.5 in.)
------------	---

Weight	1600 g
--------	--------

Environmental rating	IP66
----------------------	------

TruVision IP VF mini cameras

Electrical

Voltage input	12 VDC, PoE (IEEE 802.3af)
---------------	----------------------------

Power consumption	2MPX: Max. 7.5W 3MPX: Max. 9W 5MPX: Max. 9W
-------------------	---

Miscellaneous

Connectors	Network Port(PoE), Audio In/Out, Alarm In/Out, CVBS Output, RS-485 Port, Aux Power Port, 12 VDC Power Port
------------	--

Operating temperature	-30 to +60 °C (-22 to 140°F)
-----------------------	------------------------------

Dimensions	Ø 140 × 121.8 mm (Ø 5.51 × 4.80 in.)
Weight	1400 g (3.09 lbs.)
Environmental rating	IK10

TruVision IP VF outdoor dome cameras

Electrical

Voltage input	12 VDC/24 VAC, PoE+ (IEEE 802.3at)
---------------	------------------------------------

Power consumption	Max. 17 W
-------------------	-----------

Miscellaneous

Connectors	Network Port(PoE), 12 VDC/24 VAC Power Input, Aux Power Output, Audio In/Out, Alarm In/Out, CVBS Output.
------------	--

Operating temperature	-40 to +60°C (-40 to +140°F), with heater on
-----------------------	--

Dimensions	Ø 159.8 × 146 mm (Ø 6.29 × 5.75 in.)
------------	---

Weight	2100 g (4.62 lbs.)
--------	--------------------

Environmental rating	IP66, IK10
----------------------	------------

Pin definitions

There are eight wires on a standard UTP/STP cable and each wire is color-coded. The following shows the pin allocation and color of straight and crossover cable connection:

Figure 5: Straight-through cable

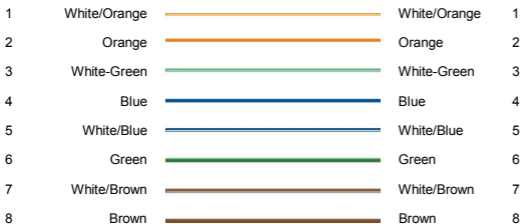
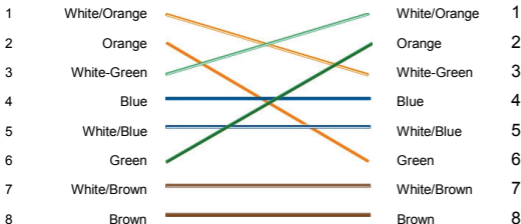

Figure 6: Cross-over cable



Please make sure your connected cables have the same pin assignment and color as above before deploying the cables in your network.

