





# TruVision DVR 15HD User Manual

<b>Copyright</b>	© 2017 United Technologies Corporation. All rights reserved. Interlogix is part of UTC Climate, Controls & Security, a unit of United Technologies Corporation. All rights reserved
<b>Trademarks and patents</b>	Trade names used in this document may be trademarks or registered trademarks of the manufacturers or vendors of the respective products.
<b>Manufacturer</b>	Interlogix 2955 Red Hill Avenue, Costa Mesa, CA 92626-5923, USA  Authorized EU manufacturing representative: UTC Fire & Security B.V. Kelvinstraat 7, 6003 DH Weert, The Netherlands
<b>FCC compliance</b>	<b>Class B:</b> This equipment has been tested and found to comply with the limits for a Class B digital device, pursuant to part 15 of the FCC Rules. These limits are designed to provide reasonable protection against harmful interference in a residential installation. This equipment generates, uses, and can radiate radio frequency energy and, if not installed and used in accordance with the instructions, may cause harmful interference to radio communications.  There is no guarantee that interference will not occur in a particular installation. If this equipment does cause harmful interference to radio or television reception, which can be determined by turning the equipment off and on, the user is encouraged to try to correct the interference by one or more of the following measures: <ul style="list-style-type: none"> <li>• Reorient or relocate the receiving antenna.</li> <li>• Increase the separation between the equipment and receiver.</li> <li>• Connect the equipment into an outlet on a circuit different from that to which the receiver is connected.</li> <li>• Consult the dealer or an experienced radio/TV technician for help.</li> </ul>
<b>FCC conditions</b>	This device complies with Part 15 of the FCC Rules. Operation is subject to the following two conditions: <ol style="list-style-type: none"> <li>(1) This device may not cause harmful interference.</li> <li>(2) This Device must accept any interference received, including interference that may cause undesired operation.</li> </ol>
<b>Canada</b>	This Class B digital apparatus complies with CAN ICES-003 (B)/NMB-3 (B). Cet appareil numérique de la classe B est conforme à la norme CAN ICES-003 (A)/NMB-3 (B).
<b>ACMA compliance</b>	<b>Notice!</b> This is a Class B product.  Class B ITE is intended primarily for use in the domestic environment and may include: <ul style="list-style-type: none"> <li>• Equipment with no fixed space of use; for example, portable equipment powered by built-in batteries</li> <li>• Telecommunication terminal equipment powered by a telecommunication network</li> <li>• Personal computers and auxiliary connected equipment</li> </ul> <b>Note:</b> The domestic environment is an environment where the use of broadcast radio and television receivers may be expected within a distance of 10 m of the apparatus concerned.
<b>Certification</b>	  

## EU directives

This product and - if applicable - the supplied accessories too are marked with "CE" and comply therefore with the applicable harmonized European standards listed under the EMC Directive 2014/30/EU, the RoHS Directive 2011/65/EU.



**2012/19/EU (WEEE directive):** Products marked with this symbol cannot be disposed of as unsorted municipal waste in the European Union. For proper recycling, return this product to your local supplier upon the purchase of equivalent new equipment, or dispose of it at designated collection points. For more information see: [www.recyclethis.info](http://www.recyclethis.info).

**2013/56/EU & 2006/66/EC (battery directive):** This product contains a battery that cannot be disposed of as unsorted municipal waste in the European Union. See the product documentation for specific battery information. The battery is marked with this symbol, which may include lettering to indicate cadmium (Cd), lead (Pb), or mercury (Hg). For proper recycling, return the battery to your supplier or to a designated collection point. For more information see: [www.recyclethis.info](http://www.recyclethis.info).

## Contact information

For contact information, see [www.interlogix.com](http://www.interlogix.com) or [www.utcssecurityproducts.eu](http://www.utcssecurityproducts.eu)



# Content

	Important information	5
<b>Chapter 1</b>	<b>Product introduction</b>	<b>6</b>
	Product overview	6
	Activate the admin password	6
<b>Chapter 2</b>	<b>Physical installation</b>	<b>8</b>
	Installation environment	8
	Unpacking the recorder and its accessories	8
	Back panel	9
	Monitor connections	10
	Rack mounting	10
<b>Chapter 3</b>	<b>Getting started</b>	<b>12</b>
	Powering on the recorder	12
	The startup wizard	13
<b>Chapter 4</b>	<b>Operating instructions</b>	<b>15</b>
	Controlling the recorder	15
	The front panel description	15
	Using the mouse	18
	Using the IR remote control	19
	Menu overview	21
<b>Chapter 5</b>	<b>Live view</b>	<b>25</b>
	Description of live view	25
	Video output	26
	Live view mouse menu	26
	Single and multiview display mode	28
	Sequencing cameras	28
	Live view toolbar	28
	Digital zoom	30
	PTZ preset and tours	30
<b>Chapter 6</b>	<b>Searching files</b>	<b>33</b>
	Advanced search video menu	33
	Search recordings	34
	Log search	37
<b>Chapter 7</b>	<b>Playback functionality</b>	<b>38</b>
	Instant playback	38
	Overview of the 24-hour playback view	39
	24-hour playback	42
	Playback speed and skip time	48
	Play back frame-by-frame	48

- Play back an archived file 49
- View a snapshot 49
- Digital zoom in playback 50
- Create video clips 50
- Create bookmarks 51
- Lock playback files 51

## **Chapter 8**

### **Archiving files 53**

- Archive files 53
- Quick Archive 54
- Archive files from search results 54
- Archive video clips and locked files 56
- Merge video files in TruVision Player 57
- Export video recordings via TruVision Navigator 57

## **Chapter 9**

### **Display settings 59**

- Display settings 59
- Layout 60

## **Chapter 10**

### **Camera setup 62**

- Supported cameras 62
- Configure the signal input channel 63
- IP camera status 64
- Camera recording settings 66
- Snapshots 68
- Camera OSD 69
- Image settings 70
- Motion detection 71
- Privacy mask 72
- Camera tamper 73
- VCA setup 74
- Configure PTZ settings 75
- PTZ presets and tours 76
- V-stream encoding 79
- Call-up the TruVision HD-TVI camera OSD menu 80

## **Chapter 11**

### **Network settings 82**

- Network settings 82
- PPPoE settings 84
- DDNS settings 85
- NTP server settings 86
- Email settings 87
- SNMP settings 88
- UPnP settings 88
- Network status 89
- Export network packet data 90
- Network statistics 91
- Port forwarding 91

<b>Chapter 12</b>	<b>Recording 92</b>
	Recording schedule 92
	Manual recording 95
<b>Chapter 13</b>	<b>Alarm and event setup 96</b>
	Set up alarm inputs 96
	Alarm response actions 97
	Set up alarm outputs 98
	Manual trigger 99
	Buzzer settings 99
	Alarm and event notification 99
	Video loss 102
	Alarm host setup 102
	Intrusion integration alarm reporting 103
	TVRMobile push notifications 107
<b>Chapter 14</b>	<b>Device management 110</b>
	Time and date settings 110
	General recorder settings 112
	Configuration files 113
	Upgrade system firmware 114
	Holiday schedules 114
<b>Chapter 15</b>	<b>Storage management 117</b>
	HDD status information 117
	Storage mode 118
	S.M.A.R.T. settings 121
	Bad sector detection 121
<b>Chapter 16</b>	<b>User management 123</b>
	Add a new user 123
	Customize a user's access privileges 124
	Local configuration settings 124
	Remote configuration settings 124
	Camera configuration settings 125
	Delete a user 125
	Modify a user 126
	Change the Admin password 126
<b>Chapter 17</b>	<b>System information 127</b>
	View system information 127
	Search the system log 130
<b>Chapter 18</b>	<b>Using the web browser 133</b>
	Internet Explorer users 133
	Access the web browser 134
	HTTPS settings 134
	Web browser live view 135

Control a PTZ dome camera via the web browser 137  
Play back recorded video 138  
Search for event logs 139  
Configure the recorder via the browser 140

<b>Appendix A</b>	<b>Specifications</b>	<b>145</b>
<b>Appendix B</b>	<b>PTZ protocols</b>	<b>147</b>
<b>Appendix C</b>	<b>Port forwarding information</b>	<b>148</b>
	Seeking further assistance	148
<b>Appendix D</b>	<b>Supported PTZ commands</b>	<b>150</b>
<b>Appendix E</b>	<b>Default menu settings</b>	<b>153</b>
	<b>Index</b>	<b>165</b>



# Important information

## Advisory messages

Advisory messages alert you to conditions or practices that can cause unwanted results. The advisory messages used in this document are shown and described below.

---

**WARNING:** Warning messages advise you of hazards that could result in injury or loss of life. They tell you which actions to take or to avoid in order to prevent injury or loss of life.

---

---

**Caution:** Caution messages advise you of possible equipment damage. They tell you which actions to take or to avoid in order to prevent damage.

---

**Note:** Note messages advise you of the possible loss of time or effort. They describe how to avoid the loss. Notes are also used to point out important information that you should read.

# Chapter 1

## Product introduction

### Product overview

This recorder is a full featured and scalable tribrid digital video recording system that can store, display, search, export, and manage video from up to 16 analog, HD analog, or IP cameras. It provides integration with the UTC portfolio of security solutions, and offers a seamless product experience within the TruVision brand.

The TVR 15HD series can be configured and operated through its on-screen display (OSD), web browser, mobile applications, TruVision Navigator software, or third party software using the TruVision SDK.

The recorder can be fully managed by the TruVision Navigator software, which is ideal for most commercial applications. Its easy and intuitive web browser interface enables remote configuration, viewing and searching of video on any TruVision recorder.

**Note:** Models are shipped with the power cords for their region.

### Activate the admin password

When you first start up the unit, the *Activation* window appears. You must define a high-security admin password before you can access the unit. There is no default password provided.

A message will appear on-screen when the unit has been activated.

**Figure 1: Password activation window**

User Name: It is always “admin”. It cannot be changed.

The bar showing password strength

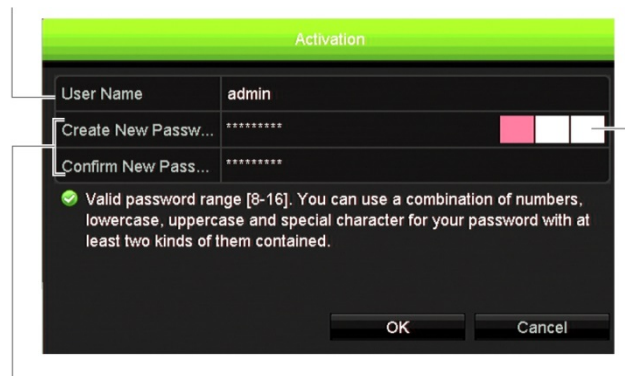

Enter the new admin password and confirm it.

### Tips on creating a strong password:

- A valid password range must be between 8 and 16 characters. You can use a combination of numbers, lower and upper case letters, and special characters : \_ - , . \* & @ / \$ ? Space. The password must contain characters from at least two of these groups.
- The password is case-sensitive so use a mixture of upper and lower case letters.
- The password must have between 8 and 16 characters.
- Do not use personal information or common words as a password.

**Note:** If you should forget your admin password, please contact Technical Support to reactivate the unit with a new password.

Go to Chapter 16 “User management” on page 123 for further information on creating user passwords.

### Default network settings

The network settings are:

- IP address - 192.168.1.82
- Subnet mask - 255.255.255.0
- Gateway address - 192.168.1.1
- Ports:

When using the browser:

RTSP port: 554

HTTP port: 80

When using TruNav:

RTSP port: 554

Server/Client software port: 8000

Go to “Using the web browser” on page 133 for further information.

# Chapter 2

## Physical installation

This section describes how to install the recorder.

### Installation environment

When installing your product, consider these factors:

- Ventilation
- Temperature
- Moisture
- Chassis load

**Ventilation:** Do not block any ventilation openings. Install in accordance with the manufacturer's instructions. Ensure that the location planned for the installation of the unit is well ventilated.

**Temperature:** Consider the unit's operating temperature (-10 to +55 °C, 14 to 131 °F) and noncondensing humidity specifications (10 to 90%) before choosing an installation location. Extremes of heat or cold beyond the specified operating temperature limits may reduce the life expectancy of the recorder. Do not install the unit on top of other hot equipment. Leave 44 mm (1.75 in.) of space between rack-mounted DVR units.

**Moisture:** Do not use the unit near water. Moisture can damage the internal components. To reduce the risk of fire or electric shock, do not expose this unit to rain or moisture.

**Chassis:** Equipment weighing less than 15.9 kg (35 lb.) may be placed on top of the unit.

### Unpacking the recorder and its accessories

When you receive the product, check the package and contents for damage, and verify that all items are included. There is an item list included in the package. If any of the items are damaged or missing, please contact your local supplier.

Items shipped with the product include:

- IR (infrared) remote control
- Two AAA batteries for the remote control
- AC power cords
- USB mouse
- Recorder
- CD with software and manuals
- *TruVision DVR 15HD Quick Start Guide*
- *TruVision DVR 15HD User Manual* (on CD)
- *TruVision Recorder Operator Guide* (on CD)

## Back panel

The figures below show the back panel connections and describe each connector on a typical TVR 15HD digital video recorder. Details may vary for specific models.

Before powering up the recorder, connect the cameras and a main monitor for basic operation. Once all required connections are done, enter the relevant data in the setup wizard (see page 13).

**Note:** For every hardwired alarm input, connect one wire to the input connection with the alarm number label and one wire to a Ground connection (labeled G).

**Figure 2: TVR 15HD back panel connections (16-channel models shown)**

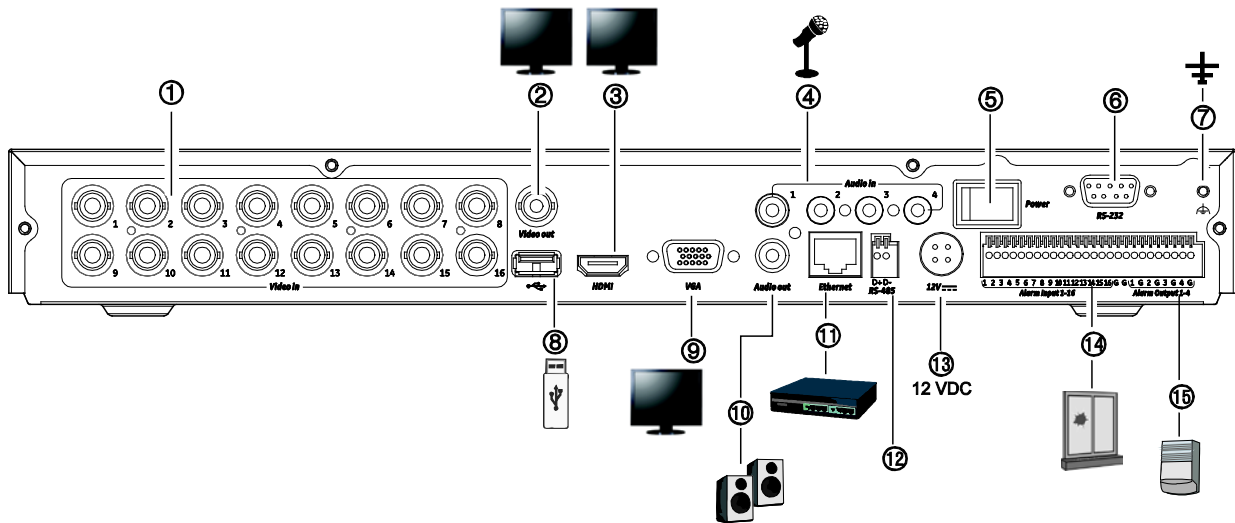

1. Connect up to 16 analog/HD-TVI cameras to BNC-type connectors (depends on the recorder model).
2. Connect one CCTV monitor (BNC-type connector).
3. Connect to a HDTV. The HDMI connection supports both digital audio and video.
4. Connect four audio inputs to RCA connectors.
5. Power switch (on/off).
6. Connect to a RS-232 device.
7. Connect to ground.
8. Connect to an optional USB device such as a mouse, CD/DVD burner or HDD.
9. Connect to a VGA monitor.
10. Connect to speakers for audio output.
11. Connect to a network.
12. Connect to a RS-485 device such as a PTZ camera or a keypad.
13. Connect to the 12 VDC PSU (included).
14. Connect up to 16 alarm inputs (depends on the recorder model).
15. Connect up to four alarm outputs (depends on the recorder model).

## Monitor connections

The recorder supports up to 1920 × 1080 / 60 Hz resolution in VGA and HDMI. The monitor resolution should be at least 1024 × 768. Adjust your monitor accordingly to this resolution.

The VGA or HDMI monitor can be used as the main monitor of the recorder. The BNC video output can be used as event or alarm monitor.

## Rack mounting

TVR 15cHD is 1U & non rack mountable. TVR 1508/16HD are rack mountable using the rack mount ears delivered with the product. See Figure 3 below.

**Figure 3: Rack-mount installation**

---

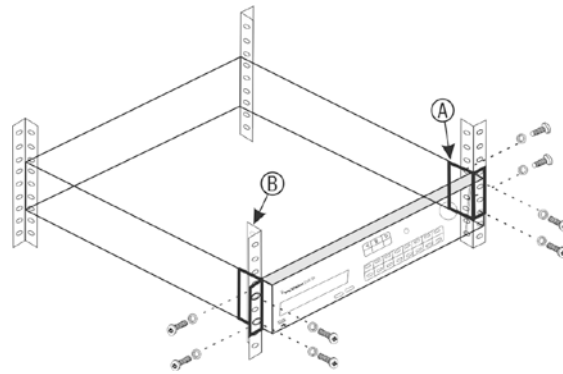
**To install the rack ears:**

1. Attach the two small front-rack mount ears (A) to the recorder (supplied).
2. Attach the recorder to the front rails (B) (screws not supplied).

# Chapter 3

## Getting started

### Powering on the recorder

Before starting the recorder, connect at least one monitor (VGA or HDMI). Otherwise, you will not be able to see the user interface and operate the device.

The recorder auto-detects the video mode (PAL or NTSC) on startup.

It comes equipped with a universal power supply that will auto-sense 110/240 V, 60/50 Hz.

**Note:** It is recommended that an uninterruptible power supply (UPS) is used in conjunction with the device.

#### To turn on the recorder:

Turn on the recorder using the power switch on the back panel. Once it is powered up, the status LEDs on the front panel will light up.

#### To turn off the recorder:

1. In live view mode, right-click the mouse and click **Menu**. The main menu window appears.
2. From the menu toolbar, click **Shutdown**.
3. In the Shutdown popup menu, select **Shutdown**. Click **Yes** to confirm shutdown.  
You will be requested to enter the Admin password.

#### To reboot the recorder:

1. In live view mode, right-click the mouse and click **Menu**. The main menu window appears.
2. Select the **Shutdown** icon.
3. In the Shutdown popup menu, select **Reboot**. Click **Yes** to confirm shutdown.  
You will be requested to enter the Admin password.



## The startup wizard

The recorder has an express installation wizard that lets you easily configure basic recorder settings when first used. It configures all cameras to default settings. The configuration of each camera and recorder can be customized as required.

By default the startup wizard will start once the recorder has loaded. It will walk you through some of the more important settings of your recorder.

Any changes you make to a setup configuration page are saved when you exit the page and return to the main wizard page.

**Note:** If you want to set up the recorder with default settings only, click **Next** in each screen until the end.

### To use the Startup wizard:

1. To launch the startup wizard without rebooting the device, go to **Menu > Device Management > General Settings** and click 'Start wizard'.
2. Select the preferred language for the system and resolution from the dropdown list and then click **Next**.
3. Enable or disable the option to start the wizard automatically when the recorder is turned on. Click **Next**.
4. In each setup configuration page, enter the desired information and then click **Next** to move to the next page. The setup configuration pages are:

Wizard setup pages	Description
User configuration	You can change the admin password and create additional users. You must enter the admin password.
Time and date configuration	Select the desired time zone, date format, system time, and system date.  If Daylight saving time (DST) is required, check <b>Enable DST</b> and enter the desired summer and winter times.  <b>Note:</b> The system time and date are visible on screen. However, they do not appear in recordings.
Network configuration	Configure your network settings such as the NIC type, IP address, subnet mask, and default gateway. Enter the preferred DNS server address as well as the alternate one to use.
HDD management	The hard drives are initialized at the factory. However if you wish to clear all data, click <b>Initialize</b> to initialize the HDD.
Adding IP cameras	Click <b>Search</b> to find any available IP cameras on the LAN.  There are two ways to add an IP camera to the recorder system:  <i>Manually:</i> Enter the IP address of the IP camera to be added. Select the appropriate protocol, stream number, and management port and then enter User name and Admin password, and then click the <b>Add</b> button. Click,

Wizard setup pages	Description
	<p><b>Next</b> to move to the next page.</p> <p><i>Automatically.</i> Select the desired IP cameras from the search results list. Click <b>Quick Add</b> to add the selected cameras to the recorder system without modifying the camera configuration. The search list will display all supported IP cameras that are located on the LAN.</p>
Recording	<p>Configure your default recording settings as required. The settings apply to all cameras connected to the recorder.</p> <p>Check the <b>Constant Recording</b> checkbox for the recorder to record continuously all day. If left unchecked, the recorder will not record.</p> <p>Check the desired time lapse check box, <b>TL-Hi</b> or <b>TL-Lo</b>.</p> <p>To record motion detection events, check <b>Event (Motion)</b>.</p> <p>To record alarm events, check <b>Alarm</b>.</p> <p><b>Note:</b> You can configure the recording parameters of each individual camera for the different recording schedules in the recording menu.</p>

- When all the required changes have been entered, a summary page appears showing all the settings.

Click **Finish** to exit the Wizard. The recorder is now ready to use.

For a description of the recorder main menu, see “Menu overview” on page 21.

# Chapter 4

## Operating instructions

### Controlling the recorder

There are several ways to control the recorder:

- Front panel control. See “The front panel description” below.
- Mouse control. See “Using the mouse” on page 18.
- IR remote control. See “Using the IR remote control” on page 19.
- TVK-800 keypad (from TVK-800 firmware version 1.0i). Please refer to the user manual for more information.
- Software (TruVision Navigator, TVRmobile). See Chapter 18 “Using the web browser” on page 133 for more information on using the web browser. Please refer to the TruVision Navigator and TVRmobile user manuals for more information.

You can use your preferred control method for any procedure, but in most cases we describe procedures using the mouse. Optional control methods are given only when they differ substantially from the mouse control methods.







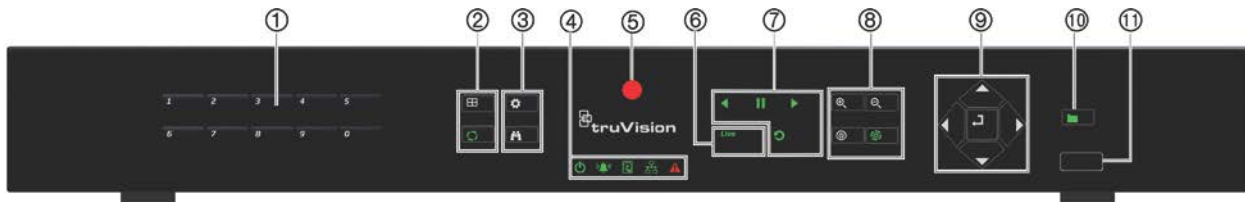



### The front panel description









The function buttons on the front panel control can be used to operate most, but not all, of the main functions of the recorder. The LED indicators light up to alert you of various conditions. The functions available can be limited by setting passwords. See Figure 4 on page 16 for more information.

**Figure 4: TVR 15HD front panel**









The controls on the front panel include:

Name	Description
1. Channel buttons	Switch between different cameras in live, PTZ control or playback modes. Use the soft keyboard to enter numerals 0 to 9.
2. Display buttons	<p> <b>Display:</b> In multiview mode, toggle through the various multiviews (full, quad, 1+5, 1+7, 9 and 16).</p> <p>In HDD information mode and user management mode delete a selected item. In PTZ mode, delete a selected key point. In Log Search mode, display the details of a log file in Log Search result.</p> <p> <b>Seq:</b> In Live View mode, start/stop sequencing cameras on the current monitor.</p>
3. Menu and Search buttons	<p> <b>Menu:</b> Enter/exit the main menu.</p> <p> <b>Search:</b> In live view, enter the advanced search menu.</p>
4. Status LEDs	<p> <b>Power:</b> A steady green light indicates the recorder is working correctly. Red indicates a fault.</p> <p> <b>Event Alarm:</b> A flashing red light indicates that there is a sensor Alarm In or another alarm such as motion or tampering. No light indicates that there is no alarm.</p> <p> <b>HDD:</b> HDD indicator steady green when data is being read from or written to the HDD. A steady red light indicates an HDD exception or error.</p> <p> <b>Tx/Rx:</b> Steady green indicates a normal network connection. No light indicates that it is not connected to a network.</p> <p> <b>Technical Alarm:</b> A steady red light indicates that there is a technical alarm from the recorder. No light indicates that there is no alarm.</p>
5. IR receiver	Receiver for IR remote.  To connect the remote control to the recorder, press the Device button, enter the device address, and press Enter. See “Using the IR remote control” on page 19 for more information.
6. Live button	<b>Live:</b> Switch to live view mode.
7. Playback buttons	<p> <b>Reverse:</b> In live view mode, use to play back the earliest video. In playback mode, playback a camera in the reverse direction.</p> <p> <b>Pause:</b> In live view, freeze the last image of the live display for all active cameras displayed. In playback mode, stop playback.</p>

Name	Description
	 <b>Play:</b> In live view mode, play all day playback of the current camera (upper-left video tile if in multiview mode). In playback mode, play back a camera in the forward direction. In search mode, play back a selected video or view a snapshot. In PTZ mode, do an auto tour.
	 <b>Playback:</b> In playback mode, start playing the current file. Starts at the beginning of the file.
8. PTZ buttons	 <b>Zoom +/-:</b> In live view mode, playback mode, and PTZ control mode use this button to zoom in and out. Also use them to navigate within menus.
	 <b>Preset:</b> In PTZ Control mode, press Preset and a numeric button to call the specified preset.  Also use to edit holiday mode, video search mode, HDD selection mode, user management mode, bookmark management, and bookmark search.
	 <b>Tour:</b> In PTZ Control mode, press Tour and a numeric button to call the specified shadow tour.  Also use to scroll between calendar months and to navigate in a text field.
9. Direction	 The DIRECTION buttons are used to navigate between different fields and items in menus.
Enter button	 The ENTER button is used to confirm selection in any of the menu modes.
10. Archive button	 Press once to enter quick archive mode. Press twice to start archiving. Indicator blinks green when data is being written to backup device.
11. USB Interface	Universal Serial Bus (USB) port for additional devices such as a USB mouse, CD/DVD burner, or USB Hard Disk Drive (HDD).

**Table 1: Front panel button functions by task**

Task	Button	Button function
Live view mode	Direction	Press to cycle through channels.
	Enter	Press to show the PTZ control toolbar.
	 Reverse	Press to play the earliest video file of the current camera (upper-left video tile if in multiview mode).
	 Pause	Press to freeze the last image of the live display for all active cameras displayed.
	 Play	Press to play 24-hour playback of the current camera (upper-left video tile if in multiview mode).
	Live	Press to switch to live view mode.
	Seq	Press to start/stop sequencing cameras on the current monitor. Hold the Seq button for three seconds to start and stop sequencing.
	Menu	Press to enter the main menu.
Playback mode	Direction	The left and right buttons are used to speed up and slow down recorded video. The up and down buttons are used to jump recorded video forwards or backwards by 30 s.
	Enter	Press the button to pause the video. Press again to restart the video.  In single-frame Playback mode, press to advance the video by a

Task	Button	Button function
		single frame.
	 Reverse	Press to play back a camera in reverse direction. In Picture Playback mode, view pictures in reverse direction.
	 Pause	In Playback mode, stop playback.
	 Play	In Playback mode, play back a camera in the forward direction.
Pause mode	Direction	The left and right buttons are used to jump recorded video forwards or backwards by one frame. The up and down buttons are used to jump recorded video forwards or backwards by one second.
PTZ control mode	Direction	Press to control the movement of the PTZ camera.
	Zoom +/-	Press to zoom in and out.
	Preset	Press Preset and a numeric button to call the specified preset.
	Tour	Press Tour and a numeric button to call the specified shadow tour.
	 Play	Press to do an auto tour.
	Display	Press to delete a selected key point from the PTZ Setting > More Settings> Tour > Key Point list.
Menu navigation	Direction	Press to navigate between different fields and items in menus.
	Menu	Enter/exit the main menu.
	Enter	Press to confirm the selection in any of the menu modes.

## Using the mouse

The USB mouse provided with the recorder can be used to operate all the functions of the unit, unlike the front panel which has limited functionality. The USB mouse lets you navigate and make changes to settings in the user interface.

Connect the mouse to the recorder by plugging the mouse USB connector into the USB port on the back panel or the front panel. The mouse is immediately operational and the pointer should appear.

**Note:** Use a USB 2.0 mouse.

Move the pointer to a command, option, or button on a window. Click the left mouse button to enter or confirm a selection.

You can purchase a spare mouse by ordering part number TVR-MOUSE-1.

See Table 2 below for a description of the mouse buttons.

**Table 2: Mouse buttons**

Item	Description	
Left button	Single-Click	<p><b>Live view:</b> Select a camera to display the live view toolbar.</p> <p><b>Menu:</b> Select a component of a menu, such as a button or an input field. This is similar to pressing the Enter button on the remote/front panel controls.</p>
	Double-Click	<p><b>Live view:</b> Switch between single screen and multi-screen mode in live/ playback mode.</p>
	Click and Drag	<p><b>Live view:</b> Drag channel/time bar.</p> <p><b>PTZ control:</b> Adjust pan, tilt and zoom.</p> <p><b>Tamperproof, privacy masking and motion detection functions:</b> Select the target area.</p> <p><b>Digital zoom-in:</b> Drag and select target area.</p>
Right button	Single-Click	<p><b>Live view:</b> Display menu.</p> <p><b>Menu:</b> Exit the current menu and return to higher level.</p>
Scroll-wheel	Scroll Up	<p><b>Live view:</b> Return to the previous window.</p> <p><b>Menu:</b> Move the selection to the previous item.</p>
	Scroll Down	<p><b>Live view:</b> Move to the next window.</p> <p><b>Menu:</b> Move the selection to the next item.</p>

## Using the IR remote control

The recorder is supplied with an infrared (IR) remote control unit. Like the mouse, it can be used to operate all of the main functions of the unit.

The IR remote control can be programmed with a unique device ID address so that the controller will only be able to communicate with recorders with that address. No programming is necessary if using a single recorder.

The device ID address only applies when using a remote control and not when using a keypad.

You can purchase a replacement remote control by ordering part number TVR-REMOTE-1.

**Figure 5: IR remote control**

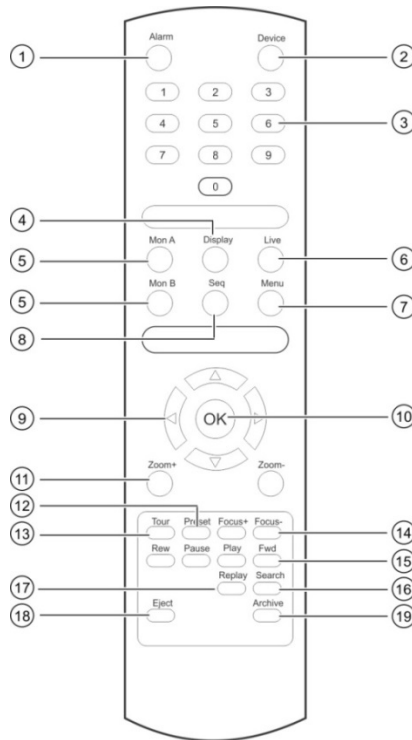

Item	Description
1. Alarm	Acknowledge an alarm.
2. Device	Enable/disable the IR remote control to control the recorder.
3. Numeric buttons	Select a camera, and enter a number in a menu option.
4. Display	Switch between the different multiview formats.
5. Mon A and Mon B	Switch between monitors A and B.
6. Live	Return to live view mode.
7. Menu	Activate the main menu.
8. Seq	Start /stop sequencing.
9. <, >, ^, v	In Menu mode: Use left or right arrow buttons to select and up or down arrow buttons to edit entry. In PTZ mode: Use to control PTZ. In Playback mode: Use to control playback speed.
10. OK	Confirm selection.
11. Zoom + and -	Use to control zoom of camera lens.
12. Preset	Enter preprogrammed three-digit code to call up a preset.
13. Tour	Enter preprogrammed three-digit code to call up shadow tour.
14. Focus + and -	Use to control focus of camera lens.
15. Playback control	Use to control playback (Rewind, Pause, Play, and Fast Forward).
16. Search	Open the Search menu.
17. Replay	Play back the selected file from the beginning.



Item	Description
18. Eject	Eject the CD or DVD disk.
19. Archive	Press once to enter quick archive mode. Press twice to start archiving.

Aim the remote control at the IR receiver located at the front of the unit to test operation.

#### To change the address of the remote control to the recorder:

1. Press the **Menu** button on the front panel or right-click the mouse and select the **Menu** button. The default display menu window appears.
2. Click **Device Management > General Settings**.
3. Check the remote control ID value. The default value is 255. This device address is valid for all IR controls.

**Note:** The recorder will respond to any remote control that has an address between 1 and 255.

4. On the remote control press the **Device** button.
5. Enter the device address value. It must be the same as that on the recorder.
6. Press the **OK** button on the remote control.

#### To place batteries into the IR remote control:

1. Remove the battery cover.
2. Insert the batteries. Make sure that the positive (+) and negative (-) poles are correctly placed.
3. Replace the battery cover.

## Troubleshooting the remote control

If the IR remote control is not functioning properly, perform the following tests:

- Check the battery polarity.
- Check the remaining charge in the batteries.
- Check that the IR remote control sensor is not masked.

If the problem still exists, please contact your administrator.

## Menu overview

The recorder has an intuitive structure that allows you to configure the unit's parameters quickly and efficiently. Each command icon displays a window that lets you edit a group of settings. Most menus are available only to system administrators.

The window is divided into three sections. The currently selected command icon and submenu item are highlighted in green. See Figure 6 below.

You must be in live view mode to access the main menu.



**Figure 6: Menu structure**











1. **Menu toolbar:** Setup options available for the selected menu function. Move the mouse over a command icon and click to select it. See Table 3 below for a description of the icons.
2. **Submenu panel:** Submenus for the selected menu function are displayed. Click an item to select it.
3. **Setup menu:** All the details for the selected submenu are displayed. Click a field to make changes.

**Note:** See Table 1 on page 16 for the description on how to access the menu options using the front panel.

**Table 3: Description of the menu toolbar icons**

Icon	Name	Description
	Display Settings	Configures display settings including video format, resolution, video output interface, dwell time, multiview format, and camera sequencing. See Chapter 9 “Display settings” on page 59.
	Camera Setup	Configures analog and IP cameras, snapshot resolution and quality, camera settings including OSD, motion detection setup, privacy masking, tampering setup, presets and shadow tours, PTZ setup, and V-stream encoding. See Chapter 10 “Camera setup” on page 62
	Network Settings	Configures standard network settings including IP address, email notifications, DDNS setup, and advanced network settings. See the Chapter 11 “Network settings” on page 82.

Icon	Name	Description
	Recording	Configures recording settings including instant playback duration, recording schedule, and manual recording. See Chapter 12 "Recording" on page 92.
	Alarm and Event Setup	Configures alarm settings including alarm input, alarm output, manual trigger, buzzer settings, alarm notifications, video loss, alarm host setup, and intrusion panel and zone setup (intrusion integration). See Chapter 13 "Alarm and event setup" on page 96.
	Device Management	Configures system settings including system date and time, DST, language, menu timeout, import/export config files, firmware upgrade, holiday schedules, and RS-232 settings. See Chapter 14 "Device management" on page 110.
	Storage Management	Configures HDD information, storage mode, S.M.A.R.T. settings, and bad sector detection. See Chapter 15 "Storage management" on page 117.
	User Management	Configures users, passwords, and access privileges. See Chapter 16 "User management" on page 123.
	System Information	Displays device information, camera setup information, recording setup information, alarm inputs information, alarm outputs information, network information, HDD information, and log search. See Chapter 17 "System information" on page 127.
	Help	Provides reference information to the various toolbars, menus, and keys within the interface.
	Shutdown	Provides access to logout, reboot, and shutdown options. See "Powering on the recorder" on page 12.

### To access the main menu:

1. In live view, press the **Menu** button on the remote control or front panel.  
- Or -  
Right-click the mouse and select **Menu** from the pop-up menu.  
The main menu window appears. The Display Settings window appears by default.
2. Click the required menu icon to display its submenu options. Modify the configuration parameters as required.
3. Click **Apply** to save the settings.
4. Click **Exit** to leave the menu setup and return to live view.

## The soft keyboard







A keyboard will appear on-screen when you need to enter characters in a window option. Click a key to input that character.

Figure 7: The soft keyboard

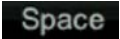

Description of the keys in the soft keyboard:

---

	Switch to lowercase/uppercase
	Space
	Exit the soft keyboard
	Alphanumeric characters
	Backspace
	Punctuation
	Confirm selection

---

## Exiting the main menu

Press the **Menu** button on the front panel to exit the current menu window and return to live view, or click **Exit** in a main menu.

# Chapter 5

## Live view







### Description of live view

Live view mode is the normal operating mode of the unit where you watch live images from the cameras. The recorder automatically enters into live view mode once powered up. On the monitor you can see whether a recording is in progress and, if set up to do so, the current date and time, as well as the camera name.

### Status information

Information on the system and camera status is displayed as icons on the main and auxiliary monitors. The camera status icons are shown for each camera. Each icon represents information on a specific item. These icons include:

**Table 4: Description of the on-screen status icons**

Icon	Description
	Indicates an alarm.
	Indicates that a camera channel is being recorded.
	Indicates a motion detection event.
 Video Loss	Indicates a video loss event.
	Indicates alarm and system event notifications. Clicking the event hint icon opens the Alarm Center window that lists all the alarm and event notifications. See “Alarm and event notification” on page 99 for more information.
	Indicates manual recording.
	Indicates that live view is locked from the front panel. Mouse actions are still allowed.

The recorder can display more than one icon at the same time.

The system status is displayed on the front panel by the status LEDs.

## Video output

The TVR 15HD has one HDMI and one VGA port.

The recorder automatically checks the monitor outputs used on startup. HDMI and VGA monitors will always be the main monitor; they will both show the same view. Monitor A is main monitor.

The event monitor (always BNC) is used to display detected events such as motion.

Only one monitor can be controlled at a time.

## Live view mouse menu

Many features of live view can be quickly accessed by placing the cursor on a live image and clicking the right-button of the mouse. The mouse menu appears (see Figure 14 below).

**Figure 8: The mouse menu for monitor A (main monitor)**

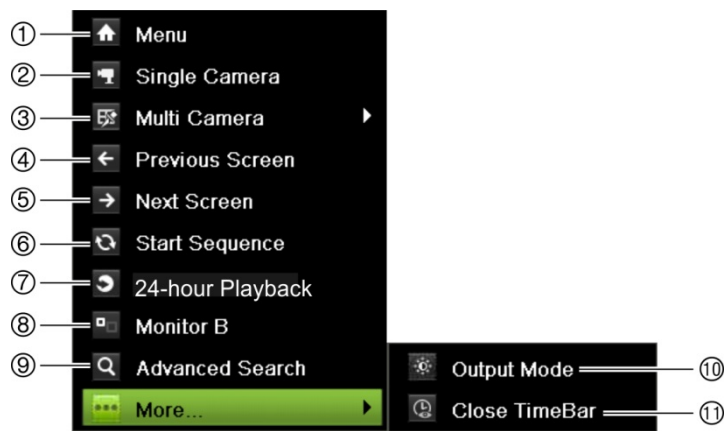

The list of commands available depends on which monitor is active; main or auxiliary (monitor B). See Table 5 on page 27. The default settings of these commands are provided in the appendix under “Default menu settings” on page 153.

**Table 5: Mouse menu for monitor A (main monitor)**

	<b>Name</b>	<b>Description</b>
1.	Menu	Enter the Main menu.  This option is not available from monitor B.
2.	Single Camera	Switch to a full-screen view for the selected camera from the dropdown list. See “Single and multiview display ” on page 28 for more information.
3.	Multi Camera	Switch between the different multiview options from the dropdown list. See “Single and multiview display ” on page 28 for more information.
4.	Previous Screen	Displays the previous camera.
5.	Next Screen	Displays the next camera.
6.	Start Sequence	Turn on sequence mode. The window automatically sequences between cameras. To set up the sequence dwell time, go to Menu > Display Settings > Display > Sequence Dwell Time and select a value.  This option is not available from monitor B.
7.	24-hour Playback	Playback the recorded video of the selected day from the selected camera. The current day is selected by default. See “24-hour playback” on page 42 for more information.
8.	Monitor B	Switch between monitors A (main) and B (event).
9.	Advanced Search	Enter the advanced video search menu. See “Advanced search video menu” on page 43 for more information.  This option is not available from monitor B.
10.	Output Mode	Select Standard, Bright, Soft, or Vivid mode to display.
11.	Close Time Bar	Open/close the time bar.

**Table 6: Mouse menu for monitor B (event monitor)**

	<b>Name</b>	<b>Description</b>
1.	Single Camera	Switch to a full-screen view for the selected camera from the dropdown list.
2.	Multi Camera	Switch between the different multiview options from the dropdown list.
3.	Previous Screen	Displays the previous camera.
4.	Next Screen	Displays the next camera.
5.	24-hour Playback	Playback the recorded video of the selected day from the selected camera. The current day is selected by default. See “24-hour playback” on page 42 for more information.
6.	Monitor A	Switch between monitors A (main) and B (event).

## Single and multiview display mode

The recorder has single and multiview formats. The number of multiview display modes available depends on the recorder model.

Single view display format	Press the numeric button on the front panel to switch to the corresponding camera display. For example, press button 10 to view camera 10.
	-Or-
	Right-click the mouse and select <b>Single Camera</b> from the menu. Select the required camera from the list.
Multiple view display format	Press the <b>Display</b> button on the front panel to cycle through different display formats.
	-Or-
	Right-click the mouse and select <b>Multi Camera</b> from the menu. Select the desired multiview display layout.

## Sequencing cameras

The sequencing feature allows a camera to be displayed briefly on screen, before advancing to the next camera in the sequence list. Sequencing can only be done in single-view display mode.

The default sequence displays each camera in numerical order. However, each camera on the main and event monitors can have a pre-programmed dwell time and sequence order. See “Layout” on page 60 for more information.

**Note:** Dwell time must not be set to zero for sequencing to function.

### Sequencing cameras using the front panel:

Select the camera where you want to start sequencing. Press the **Seq** button on the front panel to start sequencing. Press it again to stop sequencing.

### Sequencing cameras using the mouse:

Select the camera where you want to start sequencing. Right-click the mouse and select **Start Sequence** to start the sequencing. Right-click again and select **Stop Sequence** to stop sequencing.

## Live view toolbar

The live view toolbar in live view lets you quickly access regularly used commands. Position the cursor over a video image and left-click the mouse. The toolbar appears (see Figure 9 on page 29).





Figure 9: Live view toolbar



Table 7: Description of the live view toolbar icons

Icon	Description
	<b>Pause:</b> Freeze the live image of the selected camera. Although the image pauses, time and date information does not. The system clock continues to run.
	<b>Start Manual Recording:</b> Start/stop manual recording. The icon is red when manual recording is enabled. See “Recording schedule” on page 92 for information on setting up this function.
	<b>Instant Playback:</b> Playback the recorded video from the last five minutes. If no recording is found, then there was no recording made in the last five minutes. Click the icon and select the desired camera. Click OK. See “Modify the instant playback duration” on page 39 For more information.
	<b>Audio On:</b> Enable/Disable audio output. The audio option must already have been setup in the <i>Display Settings</i> menu.
	<b>Snapshot:</b> Capture a snapshot of a video image. The image is saved on the unit. See “By snapshots” on page 34 for more information.
	<b>PTZ Control:</b> Enter PTZ control mode. See “Configure PTZ settings” on page 75 for more information.
	<b>Digital Zoom:</b> Enter digital zoom. See “Digital zoom” on page 30 for further information.
	<b>Image Settings:</b> Enter the image settings menu to modify the image lighting levels. There are two options: <b>Preset Mode:</b> These are preconfigured image lighting levels. Select one of the four options depending on current lighting conditions: <ul style="list-style-type: none"> <li>- <i>Standard:</i> Use in standard lighting situations.</li> <li>- <i>Indoor:</i> Use indoors.</li> <li>- <i>Dim Light:</i> Use when the light level is low.</li> <li>- <i>Outdoor:</i> Use when outdoors. The contrast and saturation values are high.</li> </ul> <b>Customize:</b> Modify brightness, contrast, saturation, and hue values. Click Restore to restore image settings to previous values. Click <b>Restore</b> to restore image settings to previous values. Click <b>Default</b> to return to default values. These settings can also be modified from the Camera Setup > Image menu (see page “Image settings” on page 70).
	<b>Auxiliary Focus:</b> Automatically focus the camera lens for the sharpest picture.
	<b>Lens Initialization:</b> Initialize the lens of a camera with a motorized lens, such as PTZ or IP cameras. This function helps to maintain lens focus accuracy over prolonged periods of time.

Icon	Description
	<b>Stream Information:</b> Display the real-time frame rate, bit rate, resolution and video compression.
	<b>Close Toolbar:</b> Close the toolbar.

## Digital zoom

You can easily zoom in or out of a camera image in live view mode and playback using the digital zoom command. The zoom command magnifies the camera image four times. See Figure 10 below.

**Figure 10: Digital zoom window**





### To quickly zoom in/out on a camera image:

1. Left-click the mouse on the desired camera. The live view toolbar appears.
2. Click the digital-zoom icon. The digital view window appears.
3. Left-click the mouse and drag the red square to the area of interest, or press the arrow buttons on the front panel to position the red square. The selected area is magnified.
4. To exit digital zoom, right-click the mouse.

## PTZ preset and tours

When in live view you can quickly call up the list of existing presets, preset tours and shadow tours by using the front panel, remote control, mouse and keypad.



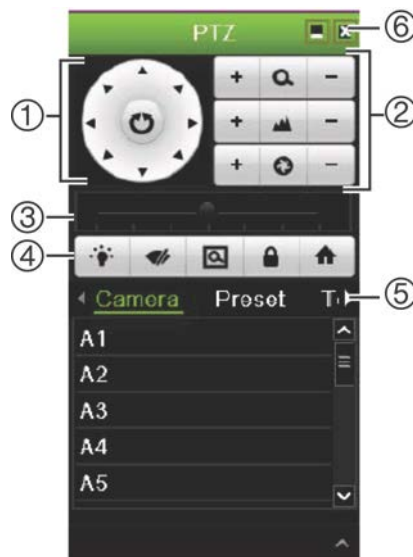

Front panel	Press <b>Enter</b> . PTZ control panel appears.
Mouse	Left-click the mouse on the desired camera image. The live view toolbar appears. Click the PTZ control icon  to enter PTZ mode. The PTZ control panel appears.
Remote control	Press the OK button. The PTZ control panel appears.
Keypad	Press the Enter  button on the keypad.

If the display was in multiview format, it changes to full-screen format for the selected camera. See Figure 11 below for a description of the PTZ control panel.

**Figure 11: PTZ control panel**



**Table 8: Description of the PTZ control panel**

Name	Description
1. Directional pad/auto-scan buttons	Controls the movements and directions of the PTZ. The center button is used to start auto-pan by the PTZ dome camera.
2. Zoom, focus, and iris	Adjusts zoom, focus and iris.
3. PTZ movement	Adjusts the speed of PTZ movement.
4. Toolbar	 Turns on/off camera light (when available).  Turns on/off camera wiper.  Zoom area.  Centers the PTZ dome camera image. This command is not supported on all PTZ dome cameras.  Jumps to the home position.
5. Select PTZ command	Displays the desired function from the scroll bar: Camera, Preset, Preset Tour or Shadow Tour.
6. Exit	Exits the PTZ control panel.

### To call up a preset:

1. In live view, left-click the mouse and select the PTZ control icon in the quick access toolbar. The PTZ control panel appears. Select the desired camera from the toolbar.

– Or –

On the front panel, select the desired camera and press  (Enter) to call up the PTZ control panel.

2. Scroll the PTZ control panel to **Preset** and double-click the desired preset from the list. The camera immediately jumps to the preset position.

### To call up a preset tour:

1. In live view, left-click the mouse and select the PTZ control icon in the live view toolbar. The PTZ control panel appears. Select the desired camera from the toolbar.

– Or –

On the front panel, select the desired camera and press  (Enter) to call up the PTZ control panel.

2. Scroll the toolbar to **Tour** and double-click the desired preset tour from the list. The camera immediately carries out the preset tour movement.

### To call up a shadow tour:

1. In live view left-click the mouse and select the PTZ Control icon in the live view toolbar. The PTZ control panel appears. Select the desired camera from the toolbar.

– Or –

On the front panel, select the desired camera and press **Enter** to call up the live view toolbar. The PTZ control panel appears.

2. Scroll the PTZ control panel to **Shadow Tour** and double-click the shadow tour from the list. The camera immediately carries out the shadow tour movement.

# Chapter 6

## Searching files

This chapter describes how to search and playback recorded videos as well as search them by time, events, bookmarks, and snapshots.

### Advanced search video menu

You can easily search and play back recorded videos by time and date, events, bookmarks, and snapshots. Recordings from both analog and IP cameras can be searched.

Figure 12: The Advanced Search menu

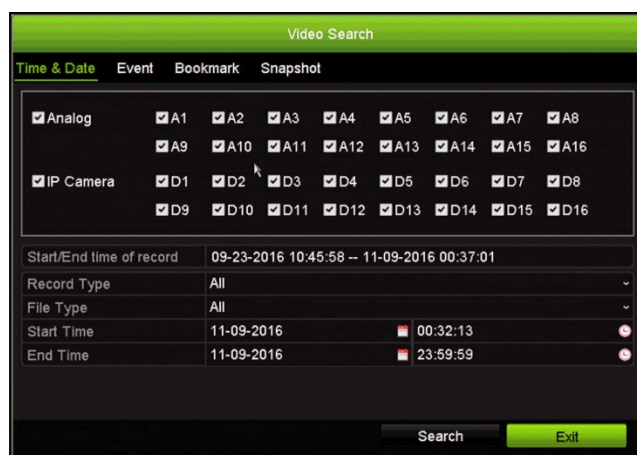

The *Search* window has four submenus that allow you to carry out different searches by theme:

Search type	Description
Time and date	Search all video by time and date of recording.
Event	Search only event recorded files. Files can be searched by alarm inputs, motion detection, or intelligent alarms.
Bookmark	Search for recorded files with bookmarks.
Snapshot	Search for snapshots.

## Search results

A search will usually produce a list of files, which may extend to several pages. The files are listed by date and time. The most recent file is listed first. You can then select a file to play it back in the playback viewer. See Figure 13 on page 34 for an example of a search.

You cannot view a full-screen playback of a search result. To do that, you need to note the time and date of the desired file to play back and do a 24-hour playback for that day. You can then locate the desired recording using the playback toolbar timeline (see Figure 14 on page 40).

A recording file can be up to 1GB in size.

Only one file can be played back at a time.

Figure 13: Example of a search result list

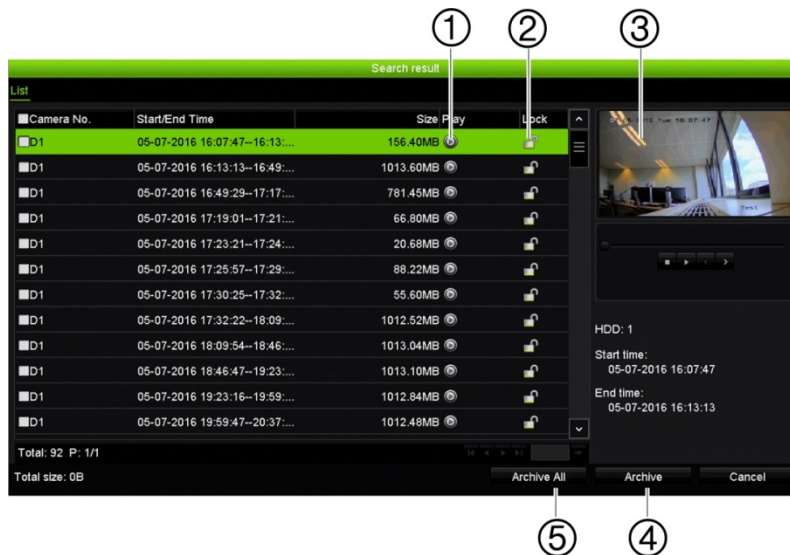

1. Click to playback the selected video.
2. Click to lock recording to prevent it from being overwritten.
3. Playback viewer
4. Archive selected files.
5. Archive all files.

## Search recordings

### By time and date

You can search recorded video by time and video type, such as continuous recordings, motion, alarms, and all recordings.

### To search video files by time and date:

1. In live view, right-click the mouse on the desired video pane and select **Advanced Search**. The Video Search menu appears.

– Or –

On the front panel, click the  Search icon.

2. In the Search menu, click the “Time & Date” tab.
3. Select the desired cameras, record type, file type as well as start and end times of the recording.
4. Click **Search**. The list of search results appears.
5. Click **Play**  on the desired file to play back the search results in the playback viewer.

### By events

You can search recorded video by event type: motion, VCA alarms, and alarm inputs.

#### To search for events:

1. In live view, right-click the mouse on the desired video pane and select **Advanced Search**. The Video Search menu appears.

– Or –

Click the Search  icon-on the front panel.

2. In the Search menu, click the “Event” tab.
3. Select the desired event type as well as start and end times of the recording.
4. Select the desired alarm inputs or channels.

If you selected “Intelligent Alarm” as the event type, select the required IP cameras.

5. Click **Search**. The list of search results appears.
6. Select the desired video from the list.
7. In the search results window, you can:

- Click **Play**  to playback the footage

- Click **Archive** to archive results

**Note:** You can modify the pre- and post-play periods of a recording.

### By bookmarked recordings

For information on creating bookmarks, see “Create bookmarks” on page 51.

### To search for a bookmark:

1. In live view, right-click the mouse on the desired video pane and select **Advanced Search**. The Video Search menu appears.

– Or –

Click the  Search icon on the front panel.

2. In the Search menu, click the “Bookmark” tab.
3. Select the desired cameras as well as start and end times of the recording to be searched. Also select the type of bookmark to be searched.

If searching for customized bookmarks, enter a keyword from the bookmark name.

Click **Search**. The list of bookmarks appears.

4. Select the desired bookmark from the list.
5. Select a bookmark and do one of the following:

Click the **Edit** button to edit a bookmark’s name.

- Or -

Click the **Delete** button to delete a bookmark.

- Or -

Click the **Play** button to play back a bookmark.

### By snapshots

You can search for snapshots of recorded video. See “Live view mouse menu” on page 26 on how to create snapshots.

### To search for snapshots:

1. In live view, right-click the mouse on the desired video pane and select **Advanced Search**. The Video Search menu appears.

– Or –

Click the  Search icon on the front panel.

2. In the Search menu, click the “Snapshot” tab.
3. Select the desired cameras as well as start and end times of the recording to be searched.

4. Click **Search**. The list of snapshots appears.

5. Select a snapshot to see it in the thumbnail window. Click its **Play**  button to see it in full-screen mode.

6. When in full-screen mode, move the cursor to the right edge of the window to see the complete list of snapshots found in the search. Click their Play buttons to see them in full-screen mode.



7. To see a slideshow of all the snapshots found, click the ► or ◀ buttons on the snapshot toolbar to sequence forwards or backwards through the shots.

## Log search

You can open video footage from the results of a log search. Refer to “Search the system log” on page 130 for more information.

# Chapter 7

## Playback functionality

The recorder lets you quickly locate and play back recorded video. There are three ways to play back video:

- Instant playback of the most recently recorded video
- 24-hour playback of one day's recorded video
- Search video by specific time, events, motion detection, bookmarks, or snapshots (see Chapter 6 "Searching files" on page 33 for further information)

The recorder continues to record the live view from a camera while simultaneously playing back video on that camera display. You must have the access privilege to play back recordings (see "Customize a user's access privileges" on page 124 for more information).

### Instant playback

Use the live view toolbar to perform instant replay of a predefined period (default time is five minutes). This can be useful to review an event that has just happened. Only one camera at a time can be selected.

You can modify the playback period in the Playback Duration menu. See page 39 for further information.

#### To instantly replay recorded video:



1. In live view mode, left-click the mouse on the desired camera image. The live view toolbar appears. Click the Instant Playback icon .

**Note:** You will be asked to enter the Admin password.

2. Click the Channel icon  and select the desired camera from the drop-down list. Click **OK**.

Playback starts immediately. The Instant Playback scroll bar appears under the selected camera.



3. Click **Pause**  on the toolbar to pause playback.  
 Click **Play**  to restart playback.  
 Click **Stop**  to stop playback and return to live view.

## Modify the instant playback duration

The live view toolbar in live view lets you quickly playback recorded video for a preprogrammed period. You can easily change this preprogrammed time period. See page 28 for more information on the live view toolbar.

To modify the preprogrammed time of this instant playback, go to **Recording > General**. Select one of the times from the drop-down list (5, 10, 20, or 30 minutes) and click **Apply**. Default is 5 minutes.

## Overview of the 24-hour playback view

It is easy to manage playback from the 24-hour playback window.

The playback video can be set up to display a time/date stamp for evidentiary purposes (see “Camera OSD” on page 69).

The playback windows for 24-hour playback and for the results of a search are different.

- 24-hour playback is in full-screen mode
- A video file of a search result is only visible in the playback viewer in the search results window. See “Search results” on page 34 for more information

Figure 14: 24-hour playback window



1. **Playback mode:** Select one of seven playback modes to view: Normal, Event, Bookmark, Smart, Sub-periods, External File, or Snapshot. See “24-hour playback” on page 42 for more information.
2. Playback viewer.
3. Full screen.
4. Exit 24-hour playback recording. Click **Exit** or right-click the mouse to return to live view.
5. **Quick camera select:**  
*Max. Camera for Playback:* From the camera list, automatically selects the first 16 cameras with recordings.  
*Min. Camera for Playback:* From the camera list, automatically select the first camera with recordings.  
**Note:** Cameras can also be selected manually. The maximum number of cameras that can be selected is 16, whether selected automatically or manually.
6. **Camera panel.** Select the cameras for playback. Move the mouse over the area to display the list of cameras available.
7. **Calendar panel.**  
*White:* No recordings.  
*Green/Yellow/Red/Pale green/Magenta:* Recordings available on the recorder.
8. **Playback control toolbar.** See Figure 15 on page 41 for more information.
9. **Time bar:** Time of actual playback. This is only displayed in 24-hour playback.
10. **24-hour recording progress bar:** This bar displays how much of the 24-hour period has been recorded.
11. **Recording type:** Description of the color coding of recording types that appear in the playback progress bar. Green indicates constant recording. Yellow indicates motion recording. Red indicates alarm recording. Pale green indicates manual recording. Magenta indicates VCA recording.

### The 24-hour playback control toolbar







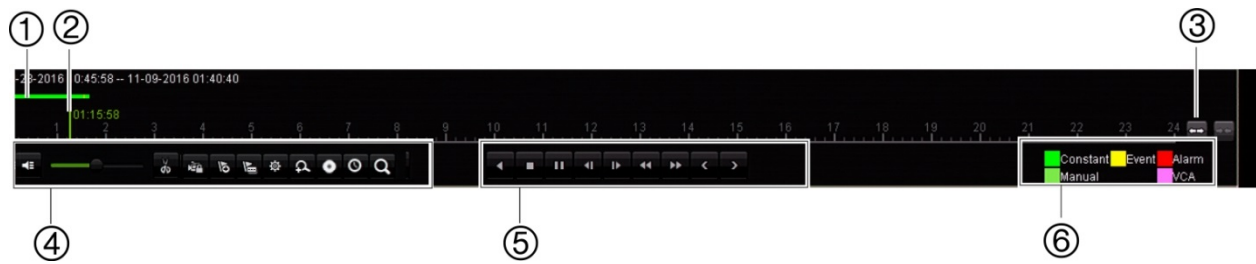













It is easy to manually control playback using the playback control toolbar. See Figure 15 on page 41 below.

**Note:** The playback control toolbar does not appear for instant playback.

Figure 15: 24-hour playback control toolbar



### Description

1. **Playback bar:** This bar displays the playback recording. It indicates in color the type of recording. Constant recording is shown in the example above.
2. **Timeline:** Allows you to jump forwards or backwards in time. The timeline moves left (oldest video) to right (newest video). Click a location on it for where you want playback to start.  
In 24-hour playback, the cursor shows the actual time.
3. Zoom in and out of the recording.
4. **Audio and video control toolbar:**
  -  /  Audio on/off.
  -  /  Start/stop a video clip during playback. Sections of a recording can be saved to an external storage device.
  -  Lock a file during playback.
  -  Add default bookmark.
  -  Add customized bookmark.
  -  File management.  
Click to see the list of video clips, snapshots, locked files, bookmarks and their times. The video clips, playback captures and locked files can be archived. Bookmarks can be renamed and deleted.
  -  Digital zoom.  
Click to enter the digital zoom function. Right click the mouse to exit.
  -  Archive files.
  -  Modify the forward and reverse skip times.
  -  Call up the Search window to search for recorded video files by time & date, events, bookmarks, and snapshots.
5. **Playback control toolbar:**
  -  Reverse play the recording. Click again to pause.
  -  Stop playback. Time displayed is 00:00:00.
  -  Play recording.
  -  Fast forward playback by the configured skip time (default is 30 seconds).
  -  Reverse playback by the configured skip time (default is 30 seconds).
  -  Decrease playback speed: Options available are: ½ speed, ¼ speed, 1/8 speed, single frame.
  -  Increase playback speed. Options available are: 2X speed, 4X speed, 8X speed, 32X speed.
  -  Play previous file/day/event recording.

Description	
	Play next file/day/event recording in the search result.
6.	<b>Recording type:</b> Description of the color coding of the five recording types that appear in the playback progress bar. Green indicates continuous recording. Yellow indicates motion detection. Red indicates alarm recording. Pale green indicates manual recording. Magenta indicates VCA recording.

## 24-hour playback

Use this option to access one day of video recordings for the selected camera. Playback starts at midnight and runs for the 24-hour period. 24-hour playback is shown in full-screen view. See Figure 15 on page 41 for a description of the playback control toolbar.

### • Using the mouse:

1. In live view mode right-click the mouse on the desired camera image. In the mouse toolbar, click **24-hour Playback**.

The playback screen appears. By default, the camera is in full-screen mode.

2. To select more than one camera for synchronous playback or to select playback from a different day, move the mouse to the right edge of the screen. The camera list and calendar are displayed. Check the desired cameras and/or another day. Up to 8 cameras can be selected for 8/16 channel recorders and up to 4 cameras for the 4-channel recorder.

Playback starts immediately you have selected the camera and times.

Note: A message appears if there are no recordings found during this period.

3. Use the playback control toolbar to manually control playback.
4. Click **Exit**  or right-click the mouse to return to live view.

– Or –

Right-click the mouse and click **Exit** from the mouse menu to return to the previous window.

### • Using the front panel:



1. Select the camera for playback and press the **Play** button. Playback from the selected camera starts immediately.

Note: Synchronous playback is only available using the mouse. If live view was showing multiview, only the camera in the top-left channel on screen will be played back.

2. To select a different camera for playback, press the numerical button of the desired camera.
3. Press **Live** to return to live view.

## 24-hour playback modes

You can select one of seven different 24-hour playback modes (see item 1 in Figure 15 on page 41). They are:

Playback mode	Description
Normal	<p>Play back recordings from the selected cameras of the selected day.</p> <p>Select the desired cameras and day to play back. Playback starts immediately.</p> <p>You can select all the playback toolbar options.</p>
Event	<p>Play back recorded selected VCA, alarm inputs or motion events. See “Event playback” on page 43 for more information.</p>
Bookmark	<p>Select the desired cameras and time period to search for bookmarks. Enter the desired keyword to search for a specific file name, if required. Click <b>Search</b>. The list of bookmarks appears. Change the pre and post-play times, if required.</p> <p>Click <b>Play</b> for the desired bookmark to play back.</p> <p>Click the <b>Exit</b> button to exit the playback of the selected bookmark and do another search, or click the <b>Search</b>  icon to open the Search window and select the Bookmark tab.</p> <p><b>Note:</b> You can only search for a bookmark by file name in the 24-hour playback mode.</p>
Smart	<p>This feature lets you selectively playback the parts of a recording with VCA and motion events and skip over video that does not have such events. See “Smart playback” on page 45” on page 43 for more information.</p>
Sub-periods	<p>This feature lets you see simultaneously the 24-hour playback recording for a selected camera split over several consecutive time periods. See “Split-screen playback” on page 46.</p> <p>Select the desired camera and number of split screens. Playback starts immediately.</p>
External file	<p>Import a file to play back.</p> <p>Insert the storage device, such as a USB flash drive, in the recorder and select a video file to play back.</p>
Snapshot	<p>Select the desired cameras and the time period. Click <b>Search</b>. The list of snapshots appears. Click <b>Play</b> to see the desired snapshot.</p> <p>To search again, click the <b>Search</b>  icon to open the Search window and select the Snapshot tab.</p>

## Event playback

This feature lets you selectively playback VCA, alarm input and motion events.

### To do an event playback:

1. In 24-hour playback mode, select **Event** from the drop-down list on the upper left-corner of the window.

2. Select the type of event to search for from the right-hand side of the window: Alarm Input, Motion, or VCA Alarm.

If you select **VCA Alarm**, select the type of VCA alarm under **Minor Type**. Also select the desired cameras to search.

If you select **Alarm Input**, select the desired alarm inputs from the list displayed.

If you select **Motion**, select the desired cameras to search.

**Note:** Motion detection must be enabled in order to use this function. See “Motion detection” on page 71 for information.

3. Select the start and end dates and times for the event search.
4. Click  Search to searching for the desired events.

The results are listed on the right side of the window. Each individual recorded event is listed. They are collectively not shown on the playback toolbar.

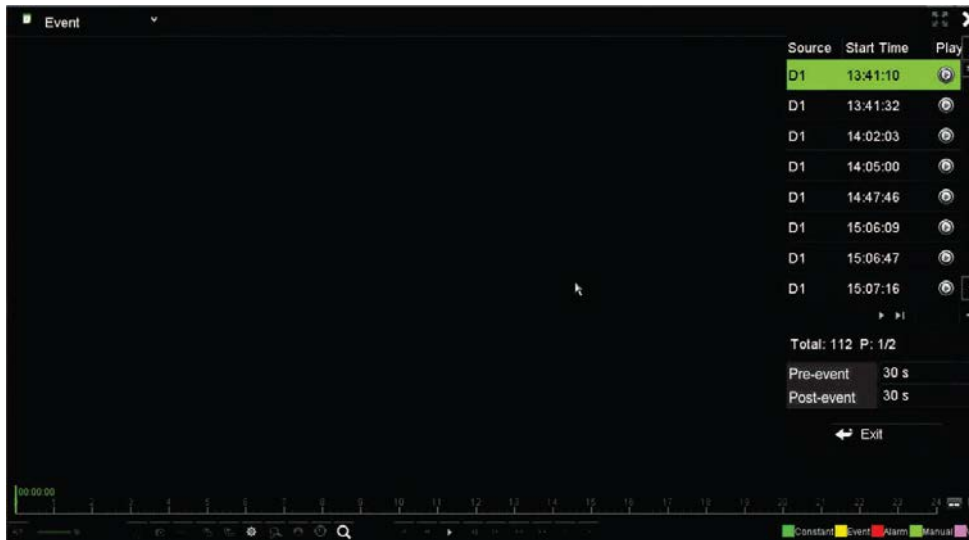

5. Select the desired pre and post-event times (between 5 and 600 seconds). Default time is 30 seconds.

**Note:** These pre and post-event times are independent to the times set for camera recordings under Camera Setup > Camera Recordings Settings. If you are only recording events, the default pre and post-event times are determined by the values set up under Camera Setup > Camera Recordings Settings. Default is 5 seconds.

6. Click the desired camera recording to play back. Its time bar also appears on the playback toolbar.
7. Click **Exit** to stop the play back and return to the previous window. You can do another search selection.
8. Click  to exit playback and return to live view.



## Smart playback

This feature lets you selectively playback the parts of a recording with VCA and motion events and skip over video that does not have such events. The *Smart Playback* mode analyses the video for VCA and motion events and marks them. See Figure 16 below.

Figure 16: Example of a smart playback recording

Smart event options

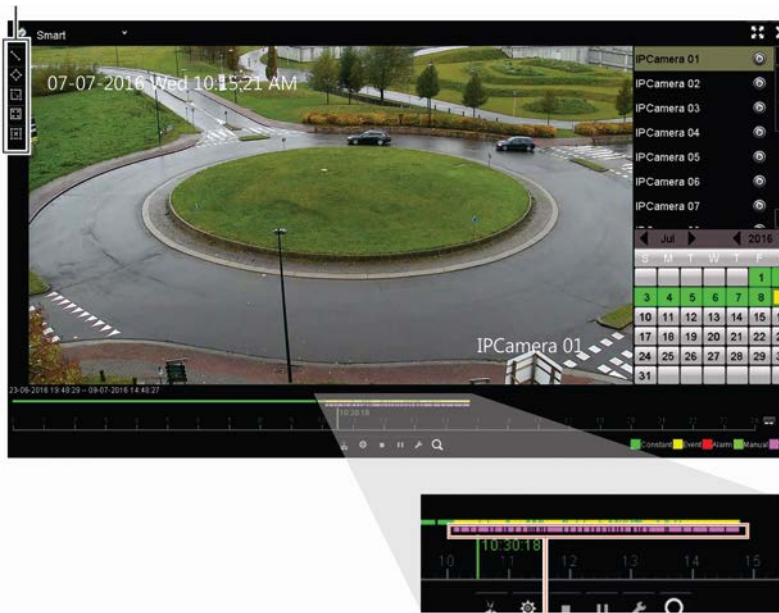











Smart bar showing all smart events found

For more information on VCA events, go to “VCA setup” on page 74.

### To do a smart playback:

1. In playback mode, select **Smart** from the drop-down list on the upper left-corner of the window.
2. Select a camera and date from the calendar on the right-hand side of the window.
3. Click  Play to start playing the recording.
4. Select the rules and areas to do a smart search for VCA or motion events in the recording.

Icon	Description
	<p><b>Cross line detection:</b> This is used to detect people, vehicles and objects crossing a pre-defined line or an area on-screen. If someone or an object crosses the line, the time of the event is shown on the Smart bar.</p> <p>Click the icon and then click on the image to indicate the start and end points of the line. If you want to change the line position, re-click the icon and draw the line again.</p>
	<p><b>Intrusion detection:</b> This is used to detect when intrusion occurs. If someone enters the selected area, the time of the event is shown on the Smart bar.</p> <p>Click the icon and then click on the image the four points on the image the set the</p>

Icon	Description
	quadrilateral area for intrusion detection. Only one area can be set. If you want to change the detection area position, re-click the icon and draw the area again.
	<b>Motion detection:</b> This is used to detect motion in a selected area. Click the icon and then drag the mouse to draw the motion detection area. <b>Note:</b> For IP cameras, you must enable motion detection in order to use this feature. For analog/HD-TVI cameras, you do not need to enable motion detection.
	<b>Motion detection:</b> This is used to detect motion over the whole image. Click the icon. By default, the whole image is selected as the detection area.
	Clear all areas selected.
	Start and stop video clipping.
	File management for video clips.
	Stop playback.
	Start or pause playback.
	Smart settings.
	Search matched video files.

- Click  Smart Settings to select the settings for the smart search:

**Skip non-related video:** Video that does not have selected events will not be played.

**Play non-related video:** Set the speed to play the video with no selected events.

**Play related video:** Set the speed to play the video with selected events.

- Click  Search to search and play back video with the matched events, which are shown in the Smart bar.

## Split-screen playback

This feature lets you see simultaneously the 24-hour playback recording for a selected camera split over several consecutive time periods.

You can display the recording between four and 16 split screens. The recording is split into equals time periods depending on the number of split screens selected. See Figure 17 below.

Figure 17: Example of split-screen playback

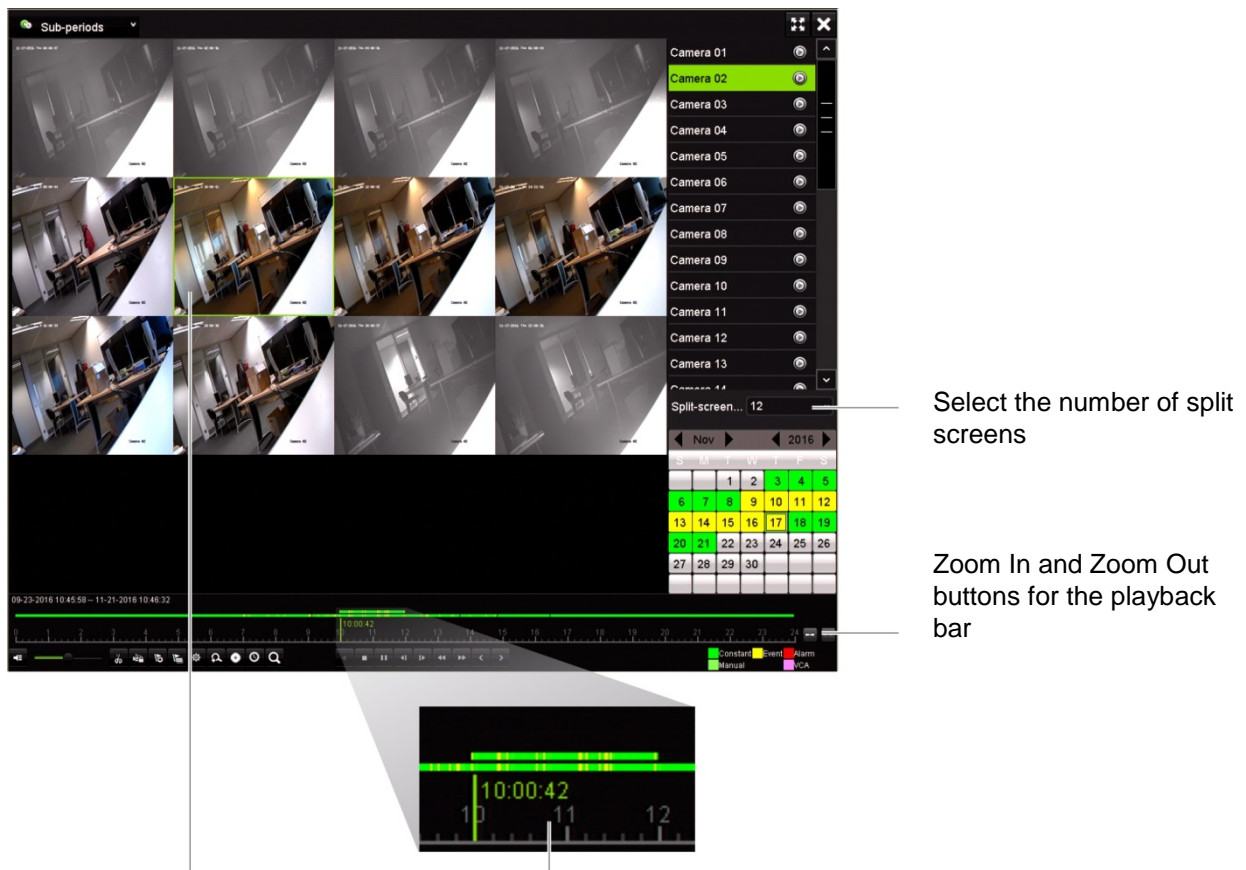

Select the number of split screens

Zoom In and Zoom Out buttons for the playback bar

Selected split screen

Playback bar of the selected split screen

### To do a split-screen playback:

1. In playback mode, select **Sub-periods** from the drop-down list on the upper left-corner of the window.
2. Select a camera and date from the calendar on the right-hand side of the window.
3. In the **Split-screen** drop-down list box, select the desired number of split screens. Up to 16 screens can be selected. Default is 3 screens.

The split screens immediately appear.

4. Click the desired screen to see the playback bar of that sub-period.
5. Click the Zoom In and Zoom Out buttons to focus in and out of the playback bar.
6. Double-click the selected screen to see the playback at full-screen. Double-click again to see the screen without the playback bar and camera list. Double-click again to return to the split-screen mode.
7. You can do video clips, bookmarks and lock files of a split-screen playback.
8. Click  to exit playback and return to live view.

## Playback speed and skip time

Use the direction buttons on the front panel to modify the playback speed, and to jump forwards or backwards.



The default skip time is 30 seconds. However, you can easily change it.

### To change the playback speed:

*From the front panel:*

Press the left and right buttons to speed up and slow down recorded video.

*From the playback window using the mouse:*

Click  and  to speed up and slow down recorded video.

### To set the playback skip time:

1. In playback mode, click  to open the pop-up *Skip Time Settings* menu.
2. Select a skip time between 10 and 300 seconds for forward and backward skip times. The default skip time is 30 seconds. Click **OK**.

### To skip forwards or backwards during playback:

*From the front panel:*

Press the up and down buttons to jump recorded video forwards and backwards by a set skip time.

*From the playback window using the mouse:*

Click  and  to jump recorded video forwards and backwards by a set skip time.

— Or —

Click a location on the timeline for where you want playback to start.

## Play back frame-by-frame

You can play back a selected video at different speeds. This allows you to carefully examine an event frame-by-frame as it happens.

The current frame rate is shown on the right of the playback control toolbar.

### To play back frame-by-frame:

#### • Using a mouse:

1. In playback mode, click the **Speed Down**  button in the playback control toolbar until the speed changes to single frame.
2. Click the **Pause** button to advance the video frame by frame.

- **Using the front panel:**

1. In playback mode move the left direction button to left to scroll down through the speed changes until single frame.
2. Press **Enter** to advance the video frame by frame.

## Play back an archived file

You can play back an archived file on your backup device using TruVision Player. However, you can also play back a file archived on your backup device using the 24-hour playback mode.

### To play back an archived file:

1. In 24-hour playback mode, select **External File** from the drop-down list on the upper left-corner of the window.
2. Select the backup device and the desired file type to play back.
3. Position the mouse over a file to see the file name.

The name includes the recording date and time. For example, the recording A0\_TVR15HD\_20161117162916.mp4 was archived November 17, 2016, at 16:29:16 (24-hour time format).

4. Click the **Play** button or double-click the desired file to play it.
5. Click **Exit** to return to the previous window.

## View a snapshot

You can view saved snapshots using the Search function. However, you can view saved snapshots using the 24-hour playback mode.

### To play back a snapshot:

1. In 24-hour playback mode, select **Snapshot** from the drop-down list on the upper left-corner of the window.
2. Select the camera(s) as well as the start and end times to search for snapshots.
3. Click **Search**. The list of snapshots found is listed.
4. Click **Play** to see the desired snapshot.
5. Click **Exit** to return to the previous window.

## Digital zoom in playback

You can zoom in on an image during playback to see it in greater detail. There are two ways to perform digital zoom in playback.

### To digitally zoom-in during playback:

1. In playback mode, click the time on the toolbar for the video that you want to view.
2. Click the **Digital Zoom** icon in the playback control toolbar.

The playback control toolbar disappears. The digital zoom window appears.



3. Left-click the mouse and drag the red square in the digital zoom window to the area of interest. The selected area is magnified.
4. Right-click the mouse to quit digital zoom mode and return to full-screen playback mode. The playback control toolbar reappears.

## Create video clips

You can save important scenes in a recorded file for later reference by creating video clips of selected portions of the file during playback. When an intruder, for example, crosses in front of several cameras you can save the video clip of the intruder's path across these cameras in a single file.

**Note:** This feature is only available using the mouse.

### To create video clips during playback:

1. Open the desired 24-hour playback window.
2. Click the playback timeline where you want the video clip to start and click the **Start Clipping**  button.
3. Click the playback timeline where you want the video clip to stop and click the **End Clipping**  button.
4. Repeat for additional clips.
5. Click the *File Management*  button and click the **Video Clips** tab to see the list of video clips saved. You cannot play them back.



To archive video clips, see “Archive video clips and locked files” on page 56”.

6. Click **Cancel** to return to 24-hour playback window.
7. Click **Exit**  to return to live view. If you have not saved the video clips, a pop-up screen will ask you if you want to save them. If you answer **Yes**, the *File Management* window will appear so that you can archive the files.

## Create bookmarks

You can bookmark the important scenes in a recorded file for later reference.

Bookmarks flag the start of a scene. Up to 64 bookmarks can be saved in a video file. There are two types of bookmarks:

- **Default bookmark** : All default bookmarks have the same generic name, "BOOKMARK".
- **Customized bookmark** : The bookmark is given a name for easy identification. The same name can be used for several bookmarks.

You can search both types.

### To create a bookmark:

1. Open the desired 24-hour playback window.
2. Click the playback timeline where you want the bookmark to be. The green time bar jumps to this position. Click the button for the type of bookmark you want and enter the bookmark name, if required.
3. Click the *File Management*  button and click the *Bookmark* tab to see the list of bookmarks saved. The name of a bookmark can be edited. A bookmark can also be deleted.

To archive locked files, see "Archive video clips and locked files" on page 56".



4. Click **Cancel** to return to the 24-hour playback window. Click **Exit**  to return to live view.

## Lock playback files

You can lock recorded files during playback so they cannot be overwritten later on. In multichannel playback using this *Lock File* function will lock all the recorded files for the playback channels.

**Note:** Locking too many files will reduce the storage capacity of the recorder.

### To lock during playback:

1. In 24-hour playback mode, click the  **Lock File** button on the playback control toolbar to lock the current recording file.
2. To see the list of locked files saved, click the  **File Management** button and in the *File Management* window, select the *Locked File* tab. The list of locked files is shown.

### To unlock a locked file

1. In 24-hour playback mode, click the  **File Management** button and in the *File Management window*, select the *Locked File* tab. The list of locked files is shown.

2. Click the lock symbol of the desired file to unlock. The file is no longer protected.



# Chapter 8

## Archiving files

Archive recorded files on an external device such as USB flash drive, USB HDDs or a DVD burner. You must be in live view to archive video. Access to archive commands may require a password.

Before starting to archive files, ensure that you have the backup device connected to the recorder. It is detected automatically by the recorder.

**Note:** The recorder supports USB DVD and USB HD on the front and back USB ports.

### Archive files

There are two ways to archive files:

**Quick Archive button:** Quick archive lets you archive recorded files quickly by using the Archive button on the front panel. The recorder then downloads all the recorded files on the unit to fill the available memory space on the media. This option is not available via the mouse.

**Search Results window:** In the search results window there is an “Archive” button. Click it to bring you to the archive window of the selected video in the search result. See “Archive files from search results” on page 54 for more information.

### TruVision Player

Use the standard file player software, TruVision Player, to play back the archived video on your PC.

The TruVision Player application for playing back videos is not automatically downloaded with the archived files. Player can be obtained from our web site and is also provided on the CD shipped with the recorder.

When you export a file using the Archive function, the unit also automatically adds a Player zipped file with *Read Me* instructions on where to go online to get the Player application. TruVision Player is not downloaded from the unit with the archive files.

Please go to the following site to download the latest Player file:

[www.interlogix.com/video/product/truvision-dvr-15](http://www.interlogix.com/video/product/truvision-dvr-15)

## Quick Archive

### To archive recorded video using Quick Archive:

1. Insert the backup device into the recorder.

If using a USB memory drive, insert the device into the USB port on the front panel. If more than one media type is found, the USB device takes precedence over the others.

2. Press the **Archive**  button on the front panel to open the *Quick Archive* window.
3. Select the files you want to archive.
4. Click **Start** or press **Archive** on the front panel again. The unit starts to download the selected files to the backup device.

**Note:** A message will appear if there is a capacity limitation on the backup device.

A message will appear to confirm when the download is complete.

## Archive files from search results

You can insert a mini-USB hub to the USB port to attach a mouse for navigation or a USB drive for archiving. However, the unit may not support all types of USB hubs.

The Archive options available may depend on the type of backup device selected.

### Archive window

After searching for all the recordings from selected parameters and cameras using *Advanced Search*, the results are listed in the Search window. When you select the desired files to archive and click the **Archive** or **Archive All** buttons, the Archive window appears (see Figure 18 on page 55).

The Archive window lists all the files currently on your backup device. The window shows the free space available on the backup device. You can also delete files from the device and search by type of files present. Files cannot be played back from the Archive window.

Figure 18: Example of an archive window

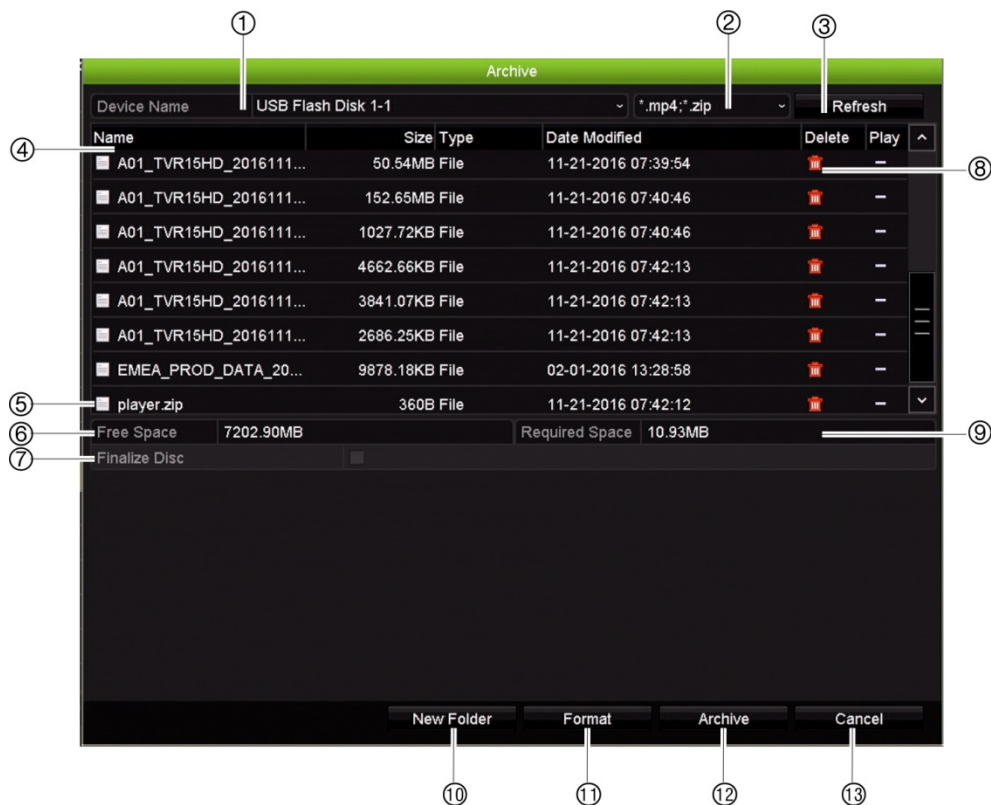

Function	Description
1. Device name	Select one of the storage media for archiving. If the backup device is not recognized: <ul style="list-style-type: none"> <li>• Click the Refresh button</li> <li>• Reconnect device</li> <li>• Check for compatibility from vendor</li> </ul>
2. Search file format	Search files on the backup device with the selected format.
3. Refresh	Refresh the search results if any parameters have been modified.
4. Name	Files found on the backup device are listed.
5. Player information file	Select to automatically include the Player tool when archiving files.
6. Free Space	Free space available on the backup device.
7. Finalize Disc	Select to prevent other files being recorded onto the disc.
8. Delete	Click to delete a selected file from the backup device.
9. Required Space	Space required on the backup device for the files to archive.
10. New Folder	Create a new folder on the backup device. Files from the recorder can be archived to a specific folder.
11. Format	Format the backup device.
12. Archive	Start downloading selected files onto the backup device.
13. Cancel	Cancel search and return to previous menu.

## Export recorded files to a backup device

### To export recorded files:

1. Connect the backup device to the recorder.  
If using a USB memory drive, insert the device into the USB port on the front panel.
2. In live view mode press the **Search** button on the front panel or remote control.  
- Or -  
Right-click the mouse and select **Advanced Search**.  
The Advanced Search window appears.
3. Select the cameras and search parameters required.
4. Click **Search**. The list of results appears.
5. Select the files to export.  
Note: You can click the **Play** button to verify that the selected files are the files to export.
6. Click **Archive**. The Archive window appears.
7. Select the storage medium to export to from the drop-down list.
8. Click **Archive** to begin the backup process of the selected files.  
- Or -  
Click **Archive All** to begin the backup process of the all the files.
9. If you have not already done so, go to the Interlogix site to download the latest Player tool to play back the files.

## Archive video clips and locked files

You can manage the video clips and locked recordings that you create during 24-hour playback.

### To archive video clips and locked files:

1. In playback mode, click the  **File Management** button. The *File Management* window appears.
2. Select the tab for the files you want to manage: *Video Clips* or *Locked File*.
3. Insert your backup device into the recorder.
4. Select the files you want to archive and click **Archive** or **Archive All**.
5. In the *Archive* window that appears, select from the drop-down list the backup device to be used.

If you want to filter the existing files already on the backup device, select the file format.

- Click **Archive**. File downloading starts.

The files are saved onto the backup device. A pop-up screen tells you when downloading is complete. The player.zip file is automatically saved with the file that tells you where to go to download the TruVision Player application.

**Note:** If you are using a USB 3.0 compatible device, it is recommended to use the USB on the back panel.

## Merge video files in TruVision Player

You can include multiple files in the TruVision Player playlist. Double-click the desired video file from the list and click the **Start** button. When the first file finishes, the next file will automatically start.

**To add exported video files to TruVision Player:**

- Click the menu icon  and select **Tool > Merge**.
- The *Merge* window appears. Click **Add File** to add the files you want to merge onto a selected video file. Under **Output Setting**, select the video file to which you want to add the files.

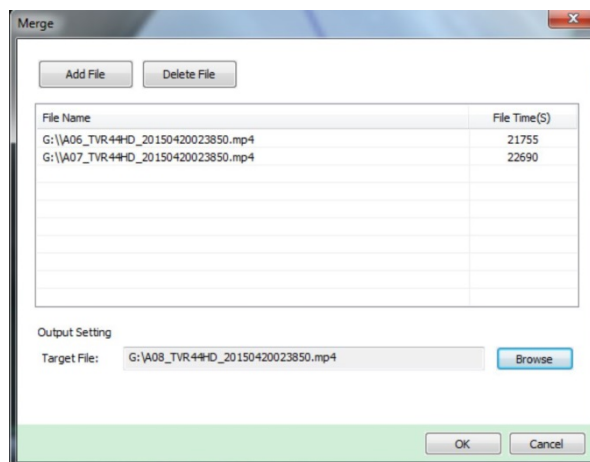

- Click **OK**.

## Export video recordings via TruVision Navigator

TruVision Navigator allows you to export a single recording file per camera. Exported video files from TruVision Navigator need to be viewed using the TruVision export file tool.

- In the playback window, drag the blue seek triangle in the Controller timeline to locate the desired time frame of the video segment.

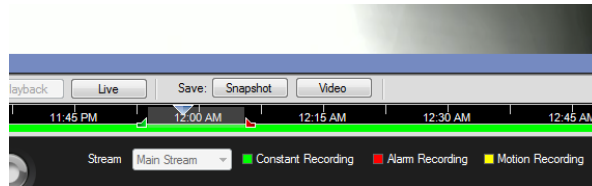

2. Slide the green and red markers of the video segment to adjust the time frame of the segment as required.

**Note:** The selected time frame can apply to multiple cameras.

3. Click the **Video** button to move the selected video segment to the Collector.
4. In the Collector, select the desired video thumbnails to export.
5. Click **Browse** and select the destination of the export file.

All selected video thumbnails will be exported as a single file.

6. Click the **Export Now** button.

# Chapter 9

## Display settings

Use the *Display Settings* menu to modify how the camera images appear on screen.

### Display settings

Use the *Display Settings* menu to adjust the settings related to the local monitor output of the recorder, such as selecting the main and event monitors, multiview layout, display the monitor time bar, sequence dwell time options, and enable or disable the local audio output. See Figure 19 below.

**Figure 19: Display Settings window**



**Table 9: Description of the Display setup window**

Option	Description
1. BNC Output Standard	Define the desired output mode. The BNC output can be used as event monitor and also produces the image that is used for the V-stream.  Select one of the options from the drop-down list: PAL or NTSC, and click <b>Apply</b> .

Option	Description
2. Picture Setting	Define the desired output mode. Select one of the options from the drop-down list: Standard, Bright, Soft, or Vivid, and click <b>Apply</b> .
3. BNC Output Brightness	Define the desired brightness by using the slider.
4. VGA/HDMI Resolution	Define the resolution of the selected monitor. Select one of the options from the drop-down list and click <b>Apply</b> . The selected resolution must be the same as that of the monitor.
5. Display Status Icons	Define whether the status icons are displayed. Default is Enabled.
6. Time Bar Transparent	Select the transparency of the monitor output time bar on screen relative to the background to make the time bar easier to read. Check the box to enable/disable. Default is Disabled.
7. Enable Time bar	Select whether the monitor output time bar appears on screen. Check the box to enable/disable. Default is Enabled.
8. Time Bar Size	Select the size of the time bar: Large, Medium, or Small. Default is Large.
9. Video Output Interface	Select the desired video output interface to apply: VGA, HDMI or V-stream/BNC. Default is VGA/HDMI.
10. Default View	The factory default multiview format displays all channels (2x2).
11. Sequence Dwell Time	Set the length of time for which a camera image is displayed on the selected monitor before moving to the next camera during sequencing. Default is off ("No Switch").
12. Enable Audio Output	Select whether to hear audio from cameras in both live and playback mode. However, in order to be able to hear audio in playback, you must enable the audio output setting. Default is Disabled. Check the box to enable/disable audio output.
13. Volume	Define the desired volume by using the slider.
14. Event Monitor	Select which monitor will be the event monitor showing full screen monitoring in case of events: VGA/HDMI or V-stream/BNC.
15. Event Full Screen Monitoring Dwell Time (s)	Set the length of time during which an image is displayed on the event monitor in full screen in case of an event. Default is 10 seconds.
Alarm Full Screen Monitoring Dwell Time (s)	Set the length of time during which an image is displayed on the event monitor in full screen in case of an alarm. Default is 10 seconds.

## Layout

The Layout window allows you to define the layout of each of the different views as they are shown when selecting the different live views or the sequencing order.

The cameras are sequenced in numeric order by default. You can change the order of the cameras for all monitors.



The camera order in the different views is consistent. This means that if Channel 2 is the first camera shown in the single camera view then it will also be the top left camera of the 4-channel view.

You can switch the tile of a camera with that of another camera in the system. This lets you, for example, have the images of camera 1 appear on tile 10, and the images of camera 10 appear on tile 1. This feature is useful when you want to watch the sequence of images from specific cameras so that they are next to each other on-screen.

See Figure 20 below. Each video tile displays both the order of the camera on screen and the camera number.

**Figure 20: Camera layout window**

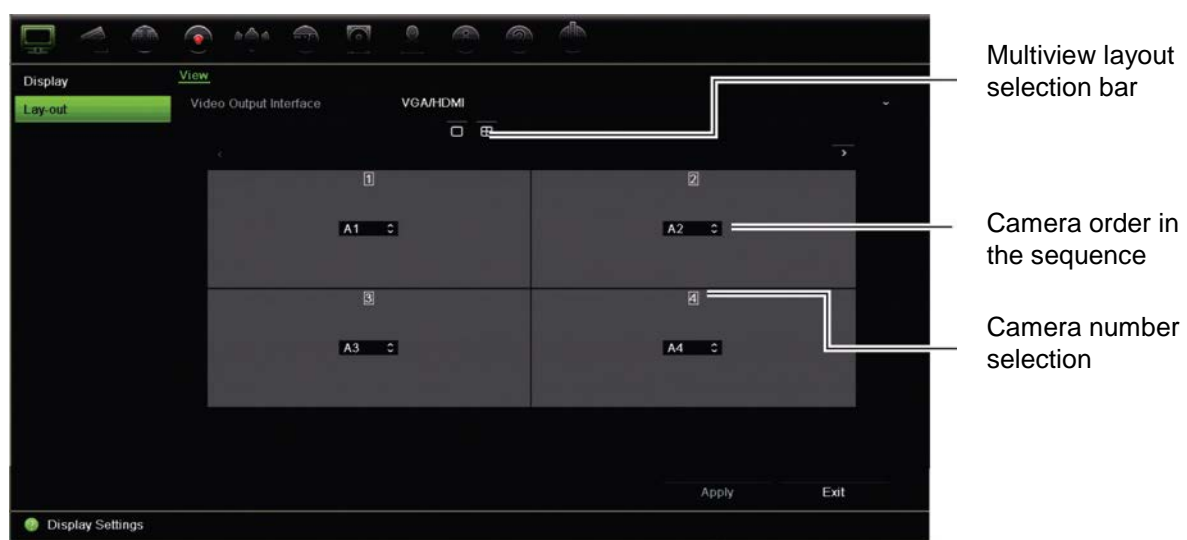

# Chapter 10

## Camera setup

Use the Camera Setup menu to configure analog and IP cameras. You can also configure the camera OSD, snapshots, recording settings, image quality, motion detection, privacy masking, camera tampering, VCA settings, PTZ configurations, V-stream settings, and people counting.

**Note:** Not all settings are available for IP cameras. For advanced IP camera settings, please consult the IP camera web browser interface.

### Supported cameras

The recorder supports the following IP cameras:

- HD-TVI cameras up to 5 MPX. Both TruVision and third party cameras are supported. HD-TVI cameras are encoded as H.264 streams.
- Standard analog cameras
- TruVision IP cameras up to 4 MPX

The analog video inputs on the recorder can automatically detect whether a camera is analog video or HD-TVI.

**Important note:** There are limitations in the number of channels that can be used when using 5 MPX cameras. Only up to a quarter of the channels are available for use. See Table 10 below for information on which channel number to use.

**Table 10: Channels available when using 5 MPX cameras**

Recorder model	Channel number available for use
TVR 150c4HD	1
TVR 1508HD	1 and 2
TVR 15016HD	1, 2, 3 and 4

## Configure the signal input channel

The recorder can support up to 16 cameras depending on the model, which can be a mix of analog and IP cameras. By default, all camera channels in the recorder are analog. You need to disable analog cameras in order to add IP cameras.

You can quickly see an overview of all the analog cameras and their status in the **Analog Camera Overview** screen (see Figure 21 below). The number of cameras displayed depends on the recorder model.

When an analog camera is enabled or disabled, the system must reboot for the changes to take effect.

**Figure 21: Analog Camera Overview window (16-channel recorder model shown)**

List of analog channels (number depends on recorder model)

List of IP channels



Maximum number of IP cameras that can be connected

### To enable or disable an analog camera:

1. From the menu toolbar, click **Camera Setup > Analog Camera Overview**.
2. Check the boxes of the analog cameras that you want to enable. Uncheck those you want to disable in order to add an IP camera.

**Note:** Every channel must be allocated to a channel type (analog or IP). If not, the following error message appears: "Please select at least one signal type".

3. Click **Apply** to save the changes.
4. A pop-up message will appear asking if you want to reboot the system. Click **Yes**.
5. Click **Exit** to return to live view.

# IP camera status

The IP Camera Status menu allows you to add, edit and remove IP cameras to the recorder, as well as update the cameras' firmware. The recorder supports all TruVision IP cameras and encoders and is compliant with ONVIF profile S cameras.

**Note:** Ensure that the ONVIF camera has been tested together with the recorder before installation.

The maximum number of IP cameras that can be connected depends on the number of analog cameras enabled. You must disable an analog camera to add an IP camera.

Figure 22: IP Camera Status window

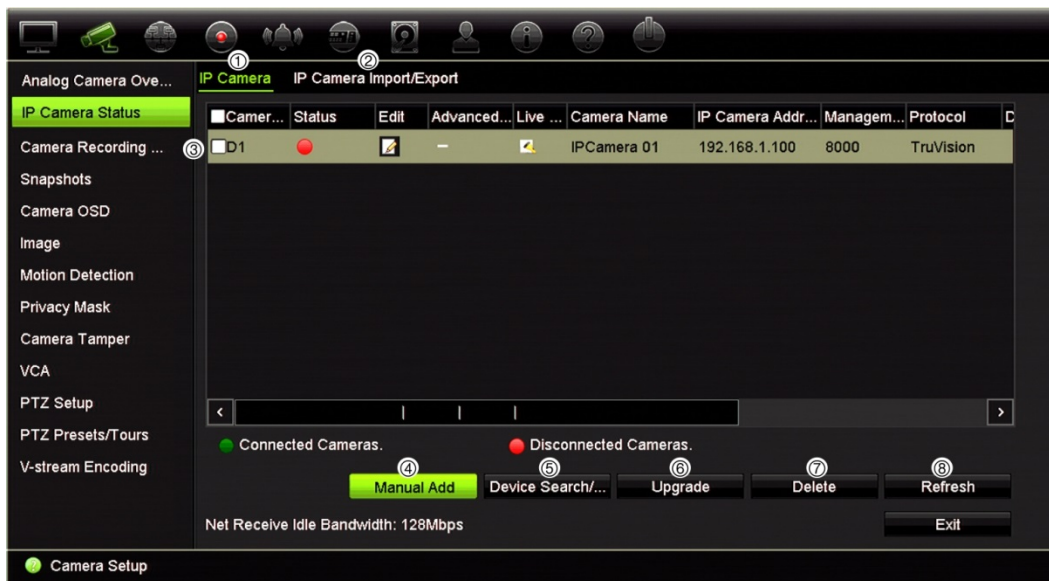

Table 11: Description of the IP camera window

Option	Description
1. IP Camera tab	This tab shows the list of IP cameras added to the recorder. The camera information shown is: Camera No., Status, Edit, Advanced Set, Live View, Camera Name, IP Camera Address, Manage Port, Protocol, Device Model, Serial Number, and Firmware.  The Status column shows whether an IP camera is connected (green) or disconnected (red).
2. IP Camera Import/Export tab	Import and export the list of IP cameras. The file format is in *.xls (MS Excel 2003).
3. IP Camera	Lets you see live view of the selected IP camera as well as change the IP camera information.  Click the Live View icon to see live view from the selected IP camera.
4. Manual Add	Add the selected cameras from the search results list to the recorder system without modifying the camera configuration.
5. Device Search/Add	Search the network for available IP cameras. Use this to add an IP camera to the recorder system.

Option	Description
6. Upgrade	Upgrade IP camera software. Insert USB flash drive in the recorder and select the upgrade file. The camera will automatically reboot once the software is upgraded.
7. Delete	Delete the selected IP camera from the list.
8. Refresh	Update the information displayed on a camera in the recorder device list.

### To automatically add an IP camera:

1. From the menu toolbar, click **Camera Setup > IP Camera Status**.
2. Click **Device Search/Add** to search for any supported IP cameras located in the recorder LAN. A list of the cameras found is displayed.

**Note:** If cameras still have default settings, they might have the same IP addresses. This creates an IP conflict. Before adding the IP camera to the recorder, use the Edit button to assign a different IP address to each camera.

3. Check the boxes of the cameras that you want to add to the recorder.
4. Click **Add** to add the selected cameras to the list of devices in the recorder. Click **Back** when complete in order to return to the main window.

**Note:** The maximum number of IP cameras that can be added is shown in the *IP Camera* tab.

The cameras are added to the end of the list of devices.

5. To test if a camera connection is operational, select the desired camera from the list of devices connected to the recorder and click **Live**. A pop-up window should appear showing the camera's live view.

**Note:** If cameras still have default settings, they might have the same IP addresses. This creates an IP conflict. Use the Edit button to assign a different IP address to each camera. Ensure that for each camera to successfully connect the cameras.

6. Click **Exit** to return to live view.

### To manually add an IP camera:

1. From the menu toolbar, click **Camera Setup > IP Camera Status**.
2. Click **Manual Add**. In the pop-up window, enter the camera details such as the IP camera address/domain, protocol, management port, user name and password. Click **OK**.

The camera is added to the end of the list of devices.

**Note:** Only one camera can be manually added at a time.

### To edit IP camera information

1. From the menu toolbar, click **Camera Setup > IP Camera Status**.
2. In the *IP Camera* tab, select a camera from the list displayed.

3. Click the **Edit**  icon of the desired camera row to get the pop-up window displaying the camera information: Camera ID number, IP camera address/domain, protocol, management port, stream number, transfer protocol, user name, and password.
4. Change the information as required.
5. Click OK to save the changes and return to the IP Camera window.
6. Click **Exit** to return to live view.

## Import/export IP camera files

You can export the configuration information on the IP cameras to an MS Excel file via the browser or through a USB port. The information in the exported file can be modified but the file structure must not be changed.

This file can also be imported to the recorder.

### To export IP camera settings:

1. Insert the archive device in a USB port of the recorder.
2. From the menu toolbar, click **Camera Setup > IP Camera Status > IP Camera Import/Export**.
3. Select the archive device and click **Export**. A pop-up message appears to say that the file has been successfully exported to the archive device and the exported file is listed on-screen.



### To import IP camera settings:

1. Insert the archive device in a USB port of the recorder with the MS Excel file to be imported.
2. From the menu toolbar, click **Camera Setup > IP Camera Status > IP Camera Import/Export**.
3. Select the archive device and click **Import**. A pop-up message appears to say that the file has been successfully exported to the recorder.

## Camera recording settings

Ensure that the HDD has been installed and initialized before configuring the recording settings. See chapter "Storage management" on page 117 for more information.

## To configure recording settings:

1. From the menu toolbar, click **Camera Setup > Camera Recording Settings**.

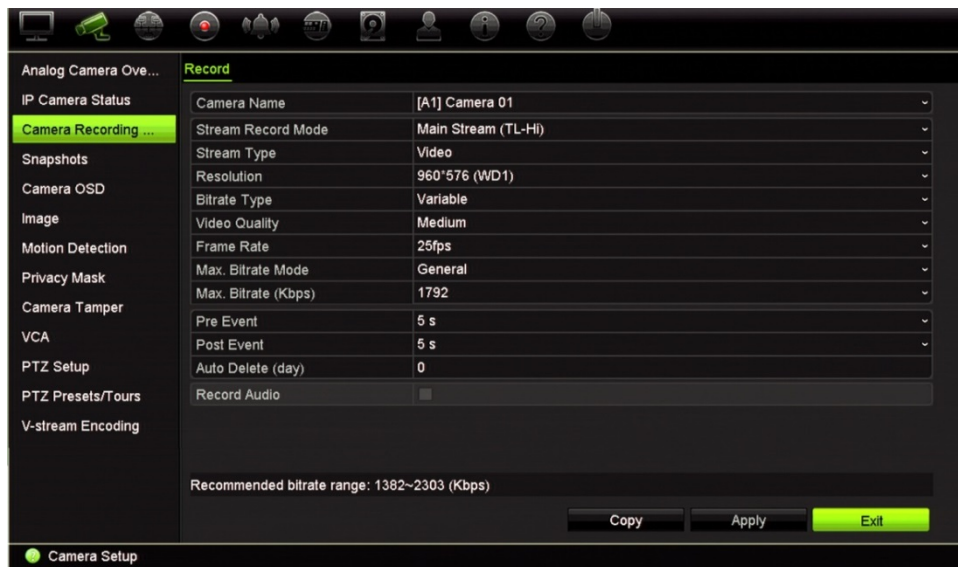

2. Select the camera you want to configure.
3. Configure the following recording settings (options available depend on the camera model):

- **Stream Record Mode:** Select one of the stream types to configure the recording parameters of that record mode: Mainstream (TL-Hi) (default), Mainstream (TL-Lo), Mainstream (Event), Mainstream (Alarm), or Substream.
- **Stream Type:** Select the type of stream to record, either video or video and audio. Default is Video.
- **Resolution:** Select the resolution of the recording. Options include (depending on the camera): 5MP, 3MP, 1920\*1080 (1080P), 1280\*720 (HD720P), 960\*576 (WD1), 704\*576 (4CIF), 640\*480 (VGA), or 352\*288 (CIF).
- **Bitrate Type:** Select Variable (default) or Constant. If “Variable” is selected, the bandwidth can vary depending on video quality and the bandwidth required. If “Constant” is selected the video streaming is always at the maximum bit rate selected.
- **Video Quality:** Select the quality at which to record. If “Constant” is selected as the bit rate type, this option is unavailable.

If a low video quality is selected, the image quality is poorer and the bandwidth required is reduced thereby allowing recording over a longer period of time.

- **Frame Rate:** Select the recording frame rate.
- **Max. Bitrate Mode:** Select the general (Default) or customized option.
- **Max. Bitrate (Kbps):** If the customized maximum bit rate mode was selected, enter the value here. It must be between 32 and 10240 kbps. It is calculated from the frame rate and time required. Default is 4096.

- **Pre Event:** This is the time the camera starts recording before the event. Select the time in seconds from the list to start pre-recording before the event. Default is 5 seconds.

The maximum pre-recording times available depend on the bit rate. See “Maximum storage times” in the appendix.

- **Post Event:** This is the time the camera continues to record after the event. Select the time in seconds from the list to stop post-recording after the event. Default is 5 seconds.
- **Auto Delete (day):** Select the number of days after which recorded video from the specified camera is permanently deleted from the HDD. A “day” is defined as the 24-hour period from when the auto delete mode (ADM) was set.

The maximum number of days that can be set is 9999. However, the actual number of days permitted depends on the HDD capacity. If the value is set to ‘0’, the option is disabled. Default is Disabled.

- **Record Audio:** Enable to record sound with the images. Default is Disabled.
4. Click **Apply** to save the settings.
  5. If you want to save these parameters to another camera, click **Copy** and select the camera in the pop-up window that appears. Click **OK** and return to the main window.
  6. Click **Apply** to save the settings.
  7. Click **Exit** to return to live view.

## Snapshots

You can define the image quality and resolution of snapshots for each camera. Snapshots can be taken at any time during live view or playback. They can also be created when an alarm occurs and sent by email or sent to an FTP server.

### To configure snapshots:

1. From the menu toolbar, click **Camera Setup > Snapshots**.
2. Select the desired camera.
3. Select the snapshot resolution from the drop-down list.  
Select QCIF, CIF, 4CIF, or Maximum. Maximum is the maximum available resolution from the camera. For analog cameras, this is the maximum available resolution in the camera. For IP cameras, this is the resolution being recorded.
4. Select the snapshot quality from the drop-down list (low, medium or high).
5. Click **Apply** to save the settings.
6. To copy the settings to other cameras, click **Copy** and select the desired cameras. Click **OK**.



- Click **Exit** to return to live view.

## Camera OSD

The recorder lets you configure which information is displayed on-screen for each individual camera.

The on-screen display (OSD) settings appear in live view mode and include the camera name, time and date. They are part of the image and are therefore also recorded.

### To configure the OSD settings:

- From the menu toolbar, click **Camera Setup > Camera OSD**.



- Under **Camera**, select the desired camera.
- Under **Camera Name**, enter a name for the camera, if required. The name can have up to 32 alphanumeric characters.
- Check the **Display Name**, **Display Date**, and **Display Day** boxes to display the camera name, date, and week.
- Select a date format and a time format.
- Select how you want the camera information displayed.

Select one of the options from the drop-down list. Default is non-transparent/non-flashing.

- Transparent & Flashing
- Transparent & Not flashing
- Non-transparent & Flashing
- Non-transparent & Not flashing

7. There are two colored text boxes in the camera view window; one for the camera name (red box) and the other for the date/time (yellow box). Using the mouse, click and drag a text box to the display position.
8. To copy the settings to other cameras, click **Copy** and select the desired cameras. Click **OK**.
9. Click **Apply** to save the settings and then click **Exit** to return to live view.

## Image settings

The Image tab allows you to adjust image settings for each individual camera channel. You may need to adjust the camera image depending on the location background in order to get the best image quality.

The system has image settings for frequently encountered lighting conditions; Standard, Indoor, Dim Light and Outdoor. You can also manually adjust the brightness, contrast, saturation, hue, sharpness, and digital noise reduction values.

You can modify the digital noise reduction (DNR) value to improve image quality. This function removes image noise from a video signal, which can be more pronounced in low light conditions.

For IP cameras more image settings may be available depending on the camera model.

**Note:** These options can also be modified from the image settings button on the live view toolbar (see “Live view toolbar” on page 28).

### To adjust display settings:

1. From the menu toolbar, click **Camera Setup > Image**.
2. Under **Camera**, select the desired camera.
3. Under **Image Setting**, select the camera for which to adjust the video image settings (Standard, Indoor, Dim Light, or Outdoor).
4. Adjust the brightness, contrast, saturation, hue, sharpness, and digital noise reduction values by dragging each scroll bar.

Click the **Default** button to return image setting values to the default position.

5. To copy the settings to other cameras, click **Copy** and select the desired cameras. Click **OK**.
6. Click **Apply** to save the settings and then click **Exit** to return to live view.

## Motion detection

The motion detection menu allows you to enable or disable motion detection for each camera, as well as create motion grids, set the sensitivity of the motion detection and link motion detection to a specific action.

### To set up motion detection:

1. From the menu toolbar, click **Camera Setup > Motion Detection**.  
Areas covered by the red grid are sensitive to motion detection.
2. Select the camera to detect motion. Each camera must be set up individually.
3. Check **Enable Motion Detection**. If this is not enabled, motion will not be recorded.
4. For IP cameras only: Check **Enable Dynamic Analysis**. This allows you to see on-screen motion being detected while setting up the feature. Areas where motion is detected are shown as solid red squares in the motion grid.

**Note:** Dynamic analysis is always enabled for analog/HD-TVI cameras.

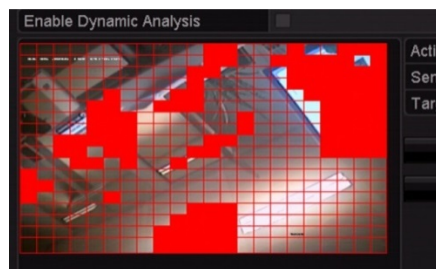

5. Create the areas on-screen to be sensitive to motion.

Click and drag the mouse cursor across the window to select areas sensitive to motion detection, which are shown as a red motion grid.



Click **Full Screen** to activate the whole screen or **Clear** to clear the screen.

6. Set the sensitivity level.

Drag the Sensitivity scroll bar to the desired sensitivity level. Default is 3. Maximum sensitivity is 5.

7. Specify the target size.

In the Target Size option, specify how many grid squares must be activated before motion is detected. Enter a value between 0 and 255 squares. Default is 1 square.

8. Select the cameras that will start the motion recording schedule once motion is detected.

Click **Actions**. The Actions window appears. Click the **Trigger Channel** tab and select the cameras that will record when a motion alarm is triggered. Click **Apply** to save the settings.

9. Select the arming schedules for motion detection.

In the Actions window, click the **Arming Schedule** tab and select the day of the week and the time periods during the day when motion can be recorded. You can schedule up to eight time periods in a day. Default is 24 hours.

Click **Apply** to save the settings. Click **Copy** to copy the settings to other days of the week.

**Note:** Time periods defined cannot overlap.

10. Link the corresponding action to motion detection.

In the Actions window, click the **Actions** tab to define the method by which you want the recorder to notify you of the alarm (see “Alarm and event notification” on page 99 for the list of alarm notification types available). “Notify Alarm Host” is the default selection. More than one option can be selected.

Click **Apply** to save settings.

11. Click **OK** to return to the motion detection settings window.

12. Click **Apply** to save all settings.

13. Click **Exit** to return to live view.

## Privacy mask

You can define an area on screen to remain hidden from view and recording. For example, you can choose to block the view of a camera when overlooking residential premises. This hidden area is referred to as privacy masking. Privacy masking cannot be viewed in live view or recorded mode, and appears as a black area on the video image.

Up to four privacy masks can be defined for one analog camera. For IP cameras, the number of privacy masks is determined by the number supported by the camera.

### To setup a privacy mask:

1. From the menu toolbar, click **Camera Setup > Privacy Mask**.
2. Select the camera for which to set up privacy masking.
3. Check the **Enable Privacy Mask** box to enable the feature.

- Set up the mask area. Up to four areas can be set (depending on the camera).

Using the mouse, click and drag a privacy-mask box in the camera view window over the desired area. You can set up to four areas for privacy masking. Masked areas are dimmed and outlined in four different colors. Click **Apply** to save settings.

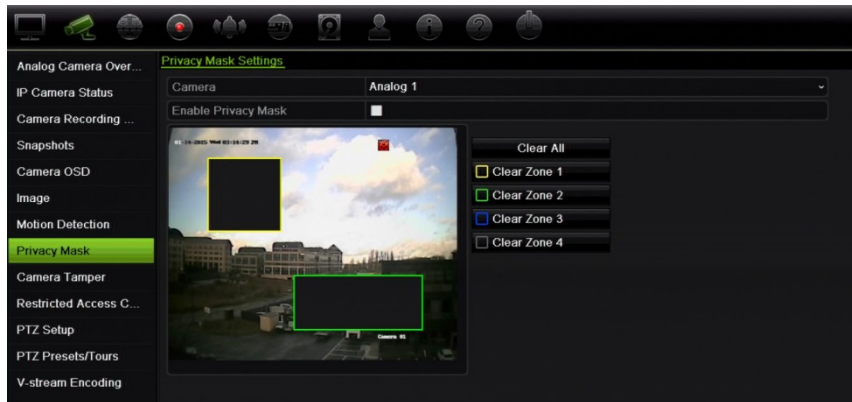

To delete a mask, click **Clear All**. All the masks are deleted.

- To copy the settings to other cameras, click **Copy** and select the desired cameras. Click **OK**.
- Click **Apply** to save the settings and then click **Exit** to return to live view.

## Camera tamper

You can setup the recorder to alert you when the camera view has changed such as when someone has deliberately blocked the camera view by spraying paint on the lens or by moving the camera. Tampering detection only applies when the whole image is covered and all light is blocked. You cannot select a specific area of the camera screen to detect tampering for analog/HD/TVI cameras. You can select a specific area for IP cameras.

**Note:** It is strongly recommended not to configure for video tampering when using PTZ dome cameras.

### To set up video tampering detection:

- From the menu toolbar, click **Camera Setup > Camera Tamper**.
- Select a camera to configure for video loss detection.
- Check the **Enable Camera Tamper** box to enable the feature.
- Select the tamper detection sensitivity level by clicking the sensitivity scroll bar. Higher sensitivity is to the right of the bar. The maximum sensitivity value is 3.
- Select the arming schedule for the tamper.

Click **Actions** and then select the **Arming Schedule** tab to select the day of the week and the time periods during the day when motion can be recorded. You can schedule up to eight time periods in a day. Default is 24 hours.

Click **Apply** to save the settings. Click **Copy** to copy the settings to other days of the week and holiday period.

**Note:** The time periods defined cannot overlap.

6. Select the response method.

Click **Actions** and then select the **Actions** tab to select the method by which you want the recorder to notify you of the alarm: Full-screen monitoring, Enable alarm audio, Notify alarm host, Send email, and Trigger alarm output. See page 97 for the description of alarm notification types.

Click **Apply** to save settings and then **OK** to return to the main window.

7. Click **Exit** to return to live view.

## VCA setup

The configuration of each individual VCA (Video Content Analysis) event is done in the camera browser. Within the recorder you can link actions to a VCA alarm from IP cameras that support this feature.

For analog cameras the VCA setup is done from the recorder (via the OSD only).

There are several types of VCA events to select. A series of linkage methods can be triggered if a VCA event is detected. See Table 12 below.

**Note:** VCA events trigger recordings; they are marked in the recorder and allow you to easily find the assisted video.

**Table 12: VCA types for analog/HD-TVI cameras**

VCA event types	Description
Cross Line Detected	This function can be used to detect people, vehicles and objects crossing a pre-defined line or an area on-screen. The line crossing direction can be set as unidirectional or bidirectional. Unidirectional is crossing the line from left to right or from right to left. Bidirectional is crossing the line from both directions.
Perimeter Intrusion Detected	You can set up an area in the surveillance scene to detect when intrusion occurs. If someone enters the area, a set of alarm actions can be triggered.
Audio Input Exception	Audio exception detection detects sounds that are above a selected threshold.
Sudden Scene Change	You can configure the camera to trigger an alarm when the camera detects a change in the scene caused by a physical repositioning of the camera.

**To setup VCA alarm actions:**

1. From the menu toolbar, click **Camera Setup > VCA**.
2. Select the camera for which to set up the VCA alarm.
3. Check the **Enable VCA Alarm** box to enable the feature.
4. Select the desired VCA type.
5. Select the recording schedules for the selected VCA.
6. Click the **Actions** button to define which actions are required with each selected VCA event from each camera.

In the Actions window, click the **Trigger Channel** tab and then select the cameras to be triggered for recording when an alarm is detected. Click **Apply** to save the settings and then **OK** to return to the VCA window.

7. Select the arming schedules for the VCA event.

In the Actions window, click the **Arming Schedule** tab and select the day of the week and the time periods during the day when motion can be recorded. You can schedule up to eight time periods in a day. Default is 24 hours.

**Note:** The time periods defined cannot overlap.

Click **Apply** to save the settings. Click **Copy** to copy these settings to other days of the week. Click **OK** to return to the VCA window.

8. Select the response method to a VCA event.

In the Actions window, click the **Actions** tab to define the method by which you want the recorder to notify you of the alarm: Full-screen Monitoring, Enable Alarm Audio, Notify Alarm Host, Send Email, Play Audio File, and Trigger Alarm Output. See page 97 for the description of alarm notification types. More than one option can be selected.

Click **Apply** to save the settings and then **OK** to return to the VCA window.

9. Select the PTZ camera function required in response to a VCA alarm.

In the Actions window, click the **PTZ Linking** tab. Select the PTZ camera and enter the number of preset, preset tour or shadow tour that is triggered when the alarm is detected.

10. Click **Apply** to save all the settings and then click **Exit** to return to live view.

## Configure PTZ settings

Use the **PTZ Setup** menu to configure only analog PTZ dome cameras. Each analog camera must be set up individually. The cameras must be configured before they can be used.

HD-TVI PTZ cameras can be controlled over the coax cable.

Ensure that the PTZ dome cameras are correctly connected to the RS-485 port on the back panel.

**Note:** If a camera does not work correctly after configuring the recorder, check the parameters entered.

**To configure PTZ dome camera settings:**

1. Click the **PTZ Control** icon on the live view toolbar.

– Or –

From the menu toolbar, click **Camera Setup > PTZ Setup**.

2. Select the camera, baud rate, data bit, stop bit, parity, flow control, PTZ protocol and address for the camera. See Appendix E “Default menu settings” on page 153 for the default values.

**Note:** It is important to ensure that the settings correspond with those used in the PTZ camera.

3. Click **Copy** to copy the settings to another camera, if required, and select the cameras.
4. Click **Apply** to save the settings and then click **Exit** to return to live view.

## PTZ presets and tours

Presets are previously defined locations of an analog PTZ dome camera. It allows you to quickly move the PTZ dome camera to a desired position. They are configured and modified from the Camera Setup > PTZ Presets/Tours window (see Figure 23 below).

Tours are series of presets. Shadow tours allow you to record the manual movement of a PTZ and follow the same tour at a later date.

**Note:** The PTZ dome camera used must be able to support a preset command. See Appendix D “Supported PTZ commands” on page 150 for the complete list of PTZ commands available by camera protocol.



Figure 23: PTZ configuration window

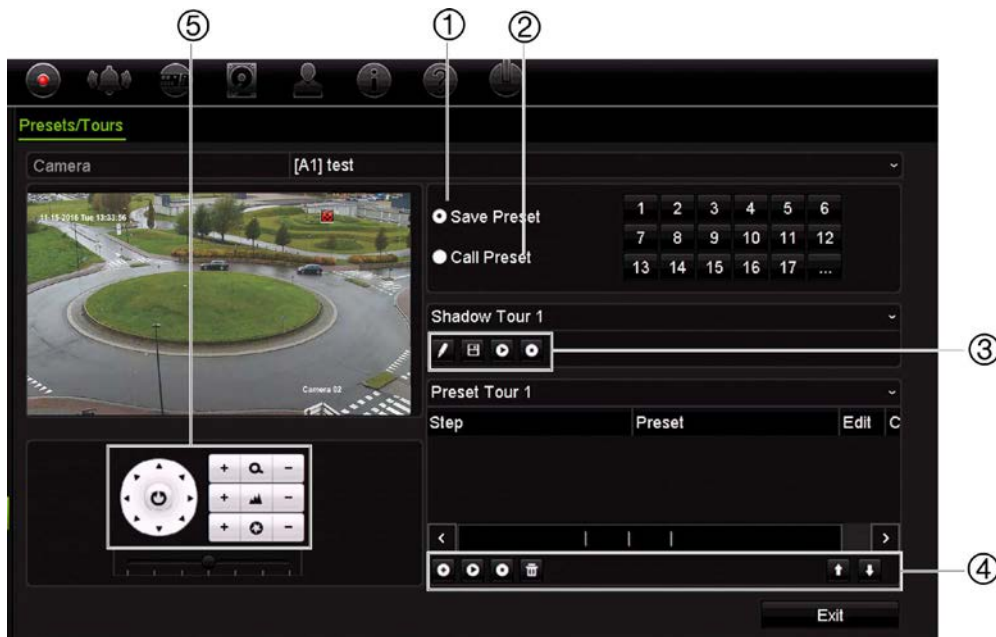











Table 13: Description of the PTZ Presets/Tours configuration window

Name	Description
1. Save Preset	Saves preset.
2. Call Preset	Calls up pre-existing preset.
3. Shadow Tour toolbar	 Starts recording the shadow tour.  Saves the shadow tour.  Starts the selected shadow tour.  Deletes the selected shadow tour.
4. Preset Tour toolbar	 Adds a step to a selected preset tour.  Starts the selected preset tour.  Stops the selected preset tour.  Deletes all the preset tour steps.  Scroll up the list.  Scroll down the list.
5. Preset control panel	

### To set up a preset:

- From the menu toolbar, click **Camera Setup > PTZ Presets/Tours**.
- Use the directional, zoom, focus and iris buttons to position the analog camera in the desired preset location.
- Check **Save Preset** and enter a preset number (1 to 255). The preset is enabled and stored in the camera.

If the desired preset number is larger than the 17 numbers listed, click [...]. The Preset window appears. Select a preset number from the dropdown list and click the **OK** button to save changes.

**Note:** Presets can be overwritten.

4. Click **Exit** to return to live view.

**To call up a preset:**

1. From the menu toolbar, click **Camera Setup > PTZ Presets/Tours**.
2. Check **Call Preset** and enter the preset number to call up. The camera immediately moves to that preset position.
3. Click **Exit** to return to live view.

**To delete a preset:**

1. From the menu toolbar, click **Camera Setup > PTZ Presets/Tours**.
2. From the preset list, select a preset number, and click  to delete the selected the preset.
3. Click **Exit** to return to live view.

**To call up a preset tour:**

1. From the menu toolbar, click **Camera Setup > PTZ Presets/Tours**.
2. Check **Call Preset** and enter the preset number to call up. The camera immediately moves to that preset position.
3. Click **Exit** to return to live view.

**To set up a preset tour:**

1. From the menu toolbar, click **Camera Setup > PTZ Presets/Tours**.
2. Select the preset tour number.
3. In the preset tour toolbar, click  to add a step to the preset tour. The Step window appears. Select the preset number, dwell time and speed of the step. Click **OK** to save the settings.



**Note:** A preset tour should have at least two presets.

4. Repeat step 3 to configure other steps in the preset tour.



5. In the preset tour toolbar, click  to call up the preset tour.
6. Click **Exit** to return to live view.

#### To call up a preset tour:

1. Click the **PTZ Settings** icon on the menu toolbar and select **More Settings**.
2. Select the desired preset tour from the list and click  to start the tour. Click  to stop the preset tour.
3. Click **Back** to return to live view.

#### To delete a preset tour:



1. From the menu toolbar, click **Camera Setup > PTZ Presets/Tours**.
2. From the preset tour list, select a tour number and click  to delete the selected the preset tour.

– Or –

In the preset tour toolbar, click  to delete all the preset tours.

3. Click **Exit** to return to live view.



#### To set up a shadow tour:

1. From the menu toolbar, click **Camera Setup > PTZ Presets/Tours**.
2. Select the shadow tour from the drop-down list.
3. To record a new shadow tour, click  and use the directional buttons on the PTZ control panel to move the camera along the desired path.
4. Click  to save the shadow tour.

**Note:** The shadow tour can be overwritten.

5. Click **Exit** to return to live view.

#### To call up a shadow tour:

1. From the menu toolbar, click **Camera Setup > PTZ Presets/Tours**.
2. Select the shadow tour from the list and click  to start the tour. Click  to stop the shadow tour.
3. Click **Exit** to return to live view.

## V-stream encoding

If the available bandwidth is limited, you can remotely view several channels in real time with one stream over the web browser or VMS (Video Management System), such as TruVision navigator, using the V-stream encoding option ("V" stands for "virtual"). When enabled, you can see the V-stream from the cameras on a remote client monitor in one stream.

### To enable V-streaming:

1. From the menu toolbar, click **Camera Setup > V-Stream Encoding**.
2. Check the **Enable V-Stream Encoding** box to enable the feature.
3. Select the **Frame Rate** from the drop-down menu.
4. Select the **Max. Bitrate** from the drop-down menu.

**Note:** The layout of the V-stream can be set up via the OSD menu (Display Settings > Layout menu (BNC)) or via the webpage.

### To configure V-streaming:

The V-stream shows video on the recorder's BNC output.

1. Click the **Display Settings > Display > Video Output Interface** and select **V-stream/BNC**.
2. Under **Default View**, select the desired view format.
3. Under **Sequence Dwell Time**, select the desired camera sequence mode.

**Note:** Sequencing can only be done in single-view display mode.

4. Click the **Display Settings > Layout > Video Output Interface** and select **V-stream/BNC**.
5. Select the desired sequence order of the cameras.
6. Click **Apply** to save the settings and **Exit** to return to live view.

## Call-up the TruVision HD-TVI camera OSD menu

TruVision HD-TVI cameras with dual video outputs (HD-TVI and standard CVBS) support the camera OSD feature. This camera OSD can be accessed via the recorder.

### To call-up the TruVision HD-TVI camera OSD menu:

1. Connect the camera's TruVision HD-TVI output directly to the recorder.  
**Note:** The camera must be connected directly to the recorder and not via a distributor.
2. In **Camera Settings** access the PTZ menu. The default protocol for the TruVision HD-TVI camera is TruVision-Coax.
3. In live view of the desired camera, click the **PTZ Control** icon on the live view toolbar to access the PTZ control panel (see "PTZ preset and tours" on page 30 for further information).
4. **Via the recorder OSD:** Click the **Iris+** or **Menu** button to open the camera's OSD menu.

**Via the browser:** Click the **Iris+** button to open the camera's OSD menu. See the camera's user manual for further information on configuring the camera. For

example, to change the language, use the left/right arrows to select Language and then the up/down arrows to select the desired language.

5. Click **EXIT** in the camera OSD menu to exit the camera OSD.

# Chapter 11

## Network settings

The Network settings menu allows you to manage all network related aspects of the recorder including general network settings, DDNS, NTP synchronization, email setup and FTP server setup.

Additionally, the Net Detect and Network statistics menus provide you with a useful and efficient tool to analyze the behavior of the recorder on the network.

You must correctly configure your recorder's network settings before using it over the network in order to:

- Connect IP cameras to it
- Connect to the recorder over the LAN
- Connect to the recorder over the internet

The recorder must have access to the internet when configuring the network settings.

## Network settings

**Note:** As every network configuration may differ, please contact your Network Administrator or ISP to see if your recorder requires specific IP addresses or port numbers.

### To configure general network settings:

1. From the menu toolbar, click **Network Settings > Network Settings**.

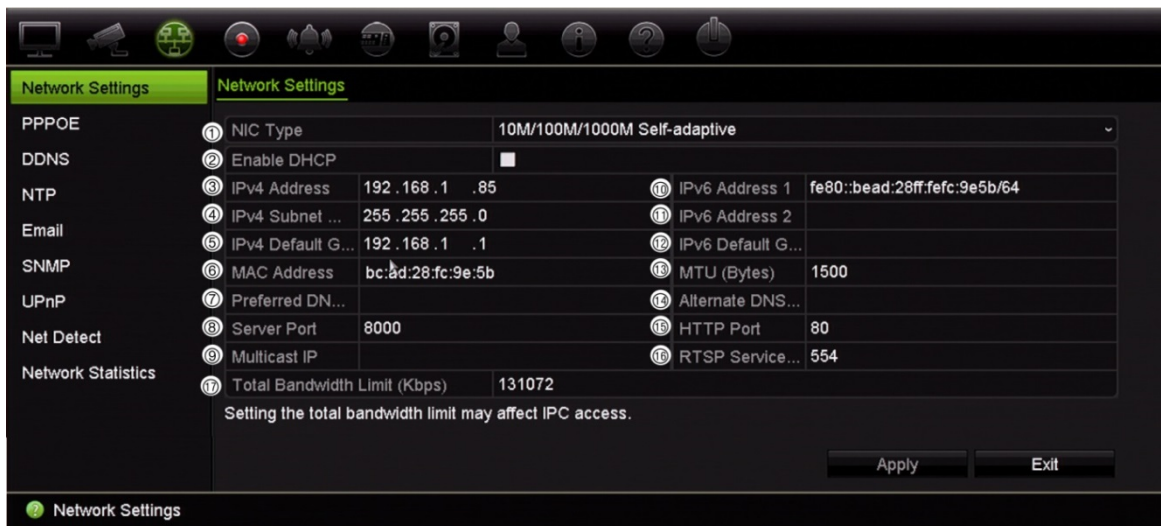

## 2. Enter the required settings:

Option	Description
1. NIC Type	Network interface card (NIC) is a device used to connect the recorder to a network. Select the NIC type used from the drop-down list.  Default value is 10/100M self-adaptive for the 4 channel recorder and 10/100/1000M self-adaptive for the 8 or 16 channel recorders.
2. Enable DHCP	DHCP (Dynamic Host Configuration Protocol) is a protocol for assigning an IP address dynamically to a device each time it connects to a network.  Check this box if you have a DHCP server running and want your recorder to automatically obtain an IP address and other network settings from that server. The DHCP server is typically available in your router.  Default value is Disabled.
3. IPv4 Address	Enter the IP address for the recorder.  Default value is 192.168.1.82.
4. IPv4 Subnet Mask	Enter the subnet mask for your network so the recorder will be recognized within the network.  Default value is 255.255.255.0.
5. IPv4 Default Gateway	Enter the IP address of your network gateway so the recorder will be recognized within the network. This is typically the IP address of your router. Consult your router user manual or contact your ISP to get the required information on your gateway.  Default value is 192.168.1.1.
6. MAC Address	Displays the MAC address. The MAC address is a unique identifier of your recorder and it cannot be changed.
7. Preferred DNS Server	Enter the preferred domain name server to use with the recorder. It must match the DNS server information of your router. Check your router's browser interface or contact your ISP for the information.
8. Server Port	Use the server port for remote client software access. The port range is between 1024 and 65535.  Enter the server port value. The default value is 8000.

Option	Description
9. Multicast IP	Enter a D-class IP address between 224.0.0.0 to 239.255.255.255. Only specify this option if you are using the multicast function. Some routers prohibit the use of multicast function in case of a network storm.
10. IPv6 Address 1	Enter the IPv6 address for the recorder. This is the IP address of the local network to which the recorder is connected.  Default value is fe80::240:3dff:fe7e:926f/64
11. IPv6 Address 2	When the recorder is connected to an external network (such as the internet), the second IPv6 address is automatically assigned.
12. IPv6 Default Gateway	Enter the IPv6 address of your network gateway so the recorder will be recognized within the network. This is typically the IP address of your router.
13. MTU (bytes)	Enter a value between 500 and 9676. Default is 1500.
14. Alternate DNS Server	Enter the alternate domain name server to use with the recorder. It must match the DNS server information of your router. Check your router's browser interface or contact your ISP for the information.
15. HTTP Port	Use the HTTP port for remote internet browser access.  Enter the HTTP port value, which can be any port number that is not occupied. The default value is 80.
16. RTSP Service Port	The RTSP (Real Time Streaming Protocol) is a network control protocol designed for use in entertainment and communications systems to control streaming media servers.  Enter the RTSP port value, which can be between 1 to 65535. The default value is 554.
17. Total Bandwidth Limit (Kbps)	The total outgoing bandwidth limit is a threshold you can set to limit the amount of outgoing bandwidth that is being handled by the recorder.

18. Click **Apply** to save the settings and **Exit** to return to live view.

## PPPoE settings

Although not usually used, you can connect the recorder directly to a DSL modem. To do this, you need to select the PPPoE option in the network settings. Contact your ISP to get the user name and password.

### To configure PPPoE settings:

1. From the menu toolbar, click **Network Settings > PPPoE**.
2. Check the enable PPPoE box.
3. Enter your user name and password, and confirm the password.
4. Click **Apply** and manually reboot the recorder to save the settings.



## DDNS settings

DDNS servers allow you to connect to your recorder using a dynamic address. This dynamic address needs to be registered with a DNS service. The DDNS setup menu allows you to enable or disable DDNS and to configure it using ezDDNS, No-IP or DynDNS.

**Note:** Some service providers block the default RTSP streaming port 554 used for video streaming, so if you are not receiving video images over the internet, you may need to change it to another value. See Appendix C “Port forwarding information” on page 137 for more information. See “Port forwarding information” in the appendix for more information.

There are three ways to set up a DDNS account:

- **ezDDNS:** A free-of-charge service included with your recorder and fully managed within the recorder interface. It is exclusive to TruVision products.
- **DynDNS:** A third-party service where users need to apply for a DynDNS account on the Dyn.com website.
- **No-IP:** A third-party service where users need to apply for a no-IP account on the no-ip.com website.

**CAUTION:** If you use the services of DynDNS or No-IP, your account user name and password for these services will be sent to them in clear text format when you set up your connection in the recorder.

Figure 24: ezDDNS setup window



**Note:** You cannot have two recorders with the same host name.

**To set up DDNS:**

1. From the menu toolbar, click **Network Settings > DDNS**.
2. Check the **Enable DDNS** box to enable this feature.
3. Select one of the DDNS types listed:

**ezDDNS:** Click the **Get URL** button. The URL address to access the unit is displayed. If no host name is specified, the DDNS will allocate one automatically.

The maximum length for the host name field is 64 characters. This limit does not include tvn-ddns.net. An example of a host name could be *max64chars.tvr-ddns.net*.

- Or -

**DynDNS:** Select **DynDNS** and enter the server address for DynDNS. In the recorder domain name field, enter the domain name obtained from the DynDNS web site. Then enter your user name and password registered in the DynDNS network.

For example:

Server address: members.dyndns.org

Domain: mycompanydvr.dyndns.org

User name: myname

Password: mypassword

- Or -

**NO-IP:** Enter server address (for example, dynupdate.no-ip.com). In the host name field, enter the host obtained from the NO-IP web site. Then enter the user name and password that are registered with the No-IP network.

4. Ask your ISP service provider for your DNS server address or look it up in the browser interface settings of your router.  
  
Go to **Network Settings** and enter the preferred and alternate DNS server addresses as well as the default gateway address.
5. Click **Apply** to save the settings and click **Exit** to return to live view.

## NTP server settings

A Network Time Protocol (NTP) server can also be configured on your recorder to keep the date and time current and accurate.

**Note:** If the device is connected to a public network, you should use a NTP server that has a time synchronization function, such as the server at the National Time Center (IP Address: 210.72.145.44) or europe.ntp.pool.org. If the device is setup in a more customized network, NTP software can be used to establish a NTP server used for time synchronization.

**To set up an NTP server:**

1. From the menu toolbar, click **Network Settings > NTP**.
2. Check the NTP box to enable feature. It is disabled by default.
3. Enter the NTP settings:
  - **Interval (min):** Time in minutes to synchronize with the NTP server. The value can be between 1 and 10080 minutes. Default is 60 minutes.
  - **NTP Server:** IP address of the NTP server.
  - **NTP Port:** Port of the NTP server.
4. Click **Apply** to save the settings and click **Exit** to return to live view.

## Email settings

The recorder can send email notifications of alarms or notifications through the network.

**Note:** Ensure that the DNS address has been set up correctly beforehand.

**To configure email settings:**

1. From the menu toolbar, click **Network Settings > Email**.
2. Enter the required settings.

Option	Description
Enable Server Authentication	Check the box if your mail server requires authentication and enter the login user name and password.
User Name	If the mail server requires authentication, enter the login user name.
Password	If the mail server requires authentication, enter the login password.
SMTP Server	Enter the SMTP server's IP address.
SMTP Port	Enter the SMTP port. The default TCP/IP port for SMTP is 25.
Enable SSL/TLS	Check the box to enable TLS and encrypt emails. If the destination server does not support TLS, the recorder will default to SSL.  If disabled, emails will not be encrypted and will be sent in clear text.
Sender	Enter the name of the sender of the email.
Sender's Address	Enter the sender's email address.
Select Receiver	Select an email recipient. Up to three receivers can be selected.
Receiver	Enter the name of the receiver of the email.
Receiver's Address	Enter the email address of the receiver.
Include Snapshot	Check the Attach JPEG File box if you want to send an email with attached alarm images.

Option	Description
Interval	Select an interval range in the Interval box.  The interval range represents the time range in between the alarm images being sent. For example, if you set the interval range at two seconds, the second alarm image will be sent two seconds after the first alarm image

3. Click **Test** to the test email settings.

**Note:** We recommend that you test the email settings after entering values in the email window.

4. Click **Apply** to save the settings and click **Exit** to return to live view.

## SNMP settings

SNMP is a protocol for managing devices on networks. When you enable SNMP in the menu, network management systems can retrieve recorder status information from the recorder via SNMP.

When you set the trap address and trap port in the recorder menu to the network management system's IP address and port number, and set up the network management system as trap receiver, trap notifications (such as startup) are sent from the recorder to the network management system.

Before configuring this function, you must first install the SNMP software.

### To configure SNMP protocol settings:

1. From the menu toolbar, click **Network Settings > SNMP**.
2. Check the **Enable SNMP** box.
3. Enter the required settings.
4. Click **Apply** to save the settings and click **Exit** to return to live view.

## UPnP settings

The recorder supports UPnP (Universal Plug and Play). This feature lets the recorder automatically configure its own port forwarding, if this feature is also enabled in the router.

You can select one of two methods to set up UPnP:

**Automatic mapped type:** The recorder automatically uses the free ports available that were set up in the Network Settings menu.

**Manual mapped type:** You enter the particular external port settings and IP addresses required to connect to the desired router (see Figure 25 on page 89).

Figure 25: UPnP auto configuration screen



### To enable UPnP:

1. Connect the recorder to the router.

**Note:** The router must support UPnP and this option must be enabled.

2. From the menu toolbar, click **Network Settings > UPnP**.
3. Check the **Enable UPnP** box.
4. From **Mapped Type**, select Auto or Manual.

If **Manual** is selected, enter the external ports and IP addresses required. Click the **Edit** icon to change the values.

5. Click **Apply** to save the settings and click **Exit** to return to live view.

## Network status

You can easily check network traffic in order to obtain information about the recorder such as its linking status, MAC address, MTU, sending/receiving rate, and NIC type.

The Network Detection window shows the network traffic between the recorder and your local network. However, the traffic between the plug and play cameras and the recorder is not shown.

You can also check the network connection status by testing its delay and packet loss.

### To check network traffic:

1. From the menu toolbar, click **Network Settings > Net Detect**. The Traffic window appears. The information displayed is refreshed once a second.

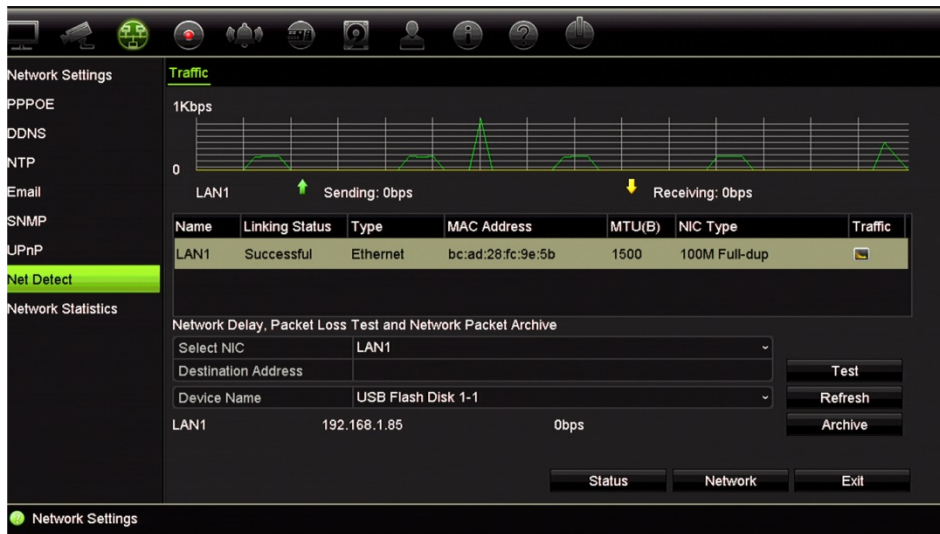

### To check network delay and packet loss:

1. From the menu toolbar, click **Network Settings > Net Detect**.
2. Under **Select NIC**, select the destination address. Click **Test**.

The test result appears in a pop-up window.

3. If you need to check the current network parameters, click the **Network** button to get an overview. The current values for NIC type, DHCP, IPv4 address, IPv4 subnet mask, IPv4 default gateway are shown as well as the preferred DNS server and alternate DNS server if used.

The **NIC Type** and **Enable DHCP** options can be changed. Click **Apply** to save any changes made and then click **OK** to return to the main window.

4. Click **Exit** to return to live view.

### To check network status:

1. When all the network parameters have been set, click the **Status** button to confirm that all parameters are operating correctly.

## Export network packet data

When the recorder is connected to a network, you can export the captured data packet to a USB-flash drive, SATA/eSATA CD-RW and other local backup devices.

### **To export network packet data:**

1. From the menu toolbar, click **Network Settings > Net Detect**.
2. Click **Refresh** to get a list of the local backup devices available, which are listed under **Device Name**. Select one from the list.
3. Click **Archive** to export the data to the backup device. Up to 1M of data can be exported at a time.
4. Click **Exit** to return to live view.

## **Network statistics**

You can easily check the bandwidth that is being used by remote live view and playback.

### **To check network statistics:**

1. From the menu toolbar, click **Network Settings > Net Statistics**.
2. The latest information is displayed on the bandwidth used by remote live view and playback as well by Net Receive Idle and Net Send Idle. Click **Refresh** to update the information.
3. Click **Exit** to return to live view.

## **Port forwarding**

When using an internet connection, ensure that the ports are open or forwarded as follows:

- **When using TruNav:** Port 8000 and 554
- **When using a web browser:** Port 80 and 554

See “Internet Explorer users” on page 133 for more information.

# Chapter 12

## Recording

Use the Recording menu to define the camera recording schedules, modify the instant playback duration, and to select the cameras for manual recording.

### Recording schedule

Defining a recording schedule lets you specify when the recorder records video and which pre-defined settings are used. Each camera can be configured to have its own recording schedule.

The schedules are visually presented on a map for easy reference. See Figure 26 below for a description of the recording schedule window.

Figure 26: Description of the recording schedule window



1. **Camera.** Select a camera.
2. **Schedule time.** Represents the 24-hour cycle during which a schedule is selected.
3. **Schedule map.** There are eight days to select: Sunday (Sun), Monday (Mon), Tuesday (Tue), Wednesday (Wed), Thursday, (Thu), Friday (Fri), Saturday (Sat), and Holiday (if enabled)..
4. **Recording type.** There are five types of recording to select, which are color-coded:  
Each square in the timeline represents an hour in the 24-hour period.



- TL-Hi (Dark green): Continuous recording. High quality time lapse. Records high quality video.
  - TL-Lo (Bright green): Continuous recording. Low quality time lapse. Records low quality video. This could be used, for example, for night recordings when few events or alarms are expected. Saving the video in low quality helps save resources on the HDD.
  - Event (Yellow): Records only events, such as motion detection.
  - Alarm (Red): Records only alarms.
  - None (Grey): No recording during this period.
5. **Edit button.** Click to modify schedules and to copy schedules to other days of the week.
  6. **Timeline.** There is a 24-hour time line for each day. Up to eight recording periods can be scheduled during the 24-hour period.
  7. **Copy button.** Click to copy schedules between cameras.

### The difference between recording and alarm/VCA/event arming schedules

The recording schedule defines when a recording can occur. The alarm and event arming schedules define when triggered alarms and motion detection can be detected. If you want to specify when triggered alarms, VCA or motion detection can or cannot be recorded, you also need to plan their arming schedules. See “Motion detection” on page 71, “VCA setup” on page 74 and “Set up alarm inputs” on page 96.

For example, for motion detection if you have deactivated the detection of motion in the arming schedule for a certain time period then if motion happens during that period it will not be recorded even if you have selected event recording type in the recording schedule.

Motion detection will also not be recorded if it is not enabled (see “Motion detection” on page 71).

## Define a schedule from the recording schedule window

### To set up a daily recording schedule:

1. From the menu toolbar, click **Recording > Recording Schedule**.
2. Select a camera.
3. Check the **Enable Recording** box to indicate that video from this camera is to be recorded.
4. Click a recording type in the legend to activate that record type. The cursor changes to a pen, and a yellow box appears around the schedule map and selected recording type.
5. Drag the pen cursor across desired hours and days in the schedule overview to mark those times with that specific record mode. To mark areas with a different record type, click on a different record type to activate it.

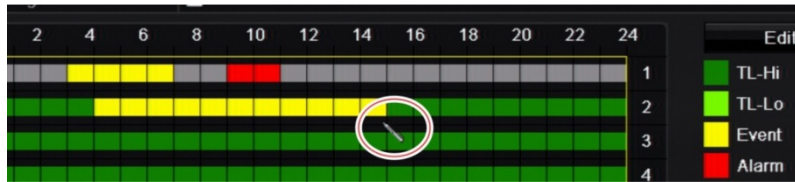

**Note:** You can schedule up to eight time periods in a day.

6. Click **Apply** to save the settings and **Exit** to return live view.

## Define a schedule from the Edit menu

To set up a daily recording schedule:

1. From the menu toolbar, click **Recording > Recording Schedule**.
2. Select a camera.
3. Check the **Enable Recording** box.
4. Click **Edit**. The following window is displayed:

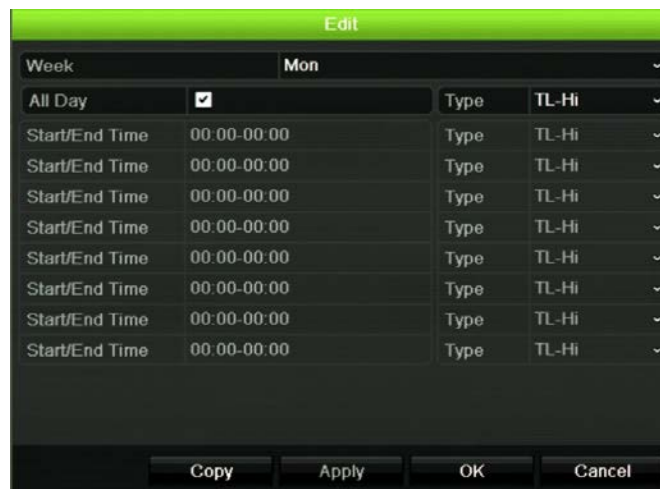

5. Select the day of the week for which you want to set up the schedule.  
You can define a different schedule for each day of the week.
6. Set the start and end time for recording.  
Define a time period by entering a start (left column) and end (right column) time. You can schedule up to eight time periods. Click **All Day** to record all day.

**Note:** Time periods defined cannot overlap.

7. Select a recording type.  
The recording type can be based on time and triggered by motion detection and/or an alarm. If set to TimeLapse (TL-Hi or TL-Low), the recorder records continuously.
8. Click **Apply** to save settings.
9. Repeat steps 4 to 8 for other days of the week or to copy the schedule settings to another day.

To copy the current schedule settings to another day of the week, click **Copy**. Select the number of the day of the week to which to copy the schedule. Click **OK** to save changes and return to the Edit window.

10. Repeat steps 4 to 9 for the other cameras.

11. Click **Apply** to save the settings and **OK** to return to the schedule window.

The recording schedule window appears showing the schedule selected (see Figure 26 on page 92 for an example).

## Manual recording

The recorder lets you manually record video during live view. This can be useful if you know that the recorder is not currently recording and you see something of interest on a camera screen that should be recorded.

Once a manual recording is started, the recording continues until it is manually stopped. If an alarm occurs during a manual recording, the alarm recording has priority over the manual recording. If a scheduled recording is already in progress when a manual recording is started, it continues to record as scheduled.

You can check to see if a camera is recording manually by looking at the icon on the live view toolbar. The icon is red when manually recording. Default is off.

There are two ways to start and stop a manual recording:

- **Use the live view toolbar**

You can start/stop manual recording for each camera individually. Position the cursor over a camera image and left-click the mouse to display the live view toolbar. Click the manual record icon to start or stop manual recording. The icon is red when recording.

- **Use the configuration menu**

This option lets you select more than one camera at a time. Go to **Recording > Manual Recording** to access the manual recording menu and check the boxes of the cameras to start or stop manual recording.

# Chapter 13

## Alarm and event setup

This chapter describes the alarm and event setup menu and provides more information on the different types of alarms and connected responses. Alarms are all notifications related to either physical alarm inputs on recorders and cameras or anything that does not work as expected: device errors, network issues, and video loss.

### Set up alarm inputs

The recorder can be configured to record when an alarm is triggered by an external alarm device (for example, PIR detector, dry contacts...). They are the physical inputs on the cameras and recorder.

#### To set up external alarms:

1. From the menu toolbar, click **Alarm & Event Setup > Alarm Input**.



2. Select the alarm input number of a camera, which corresponds to the connector on the back panel of the recorder, and enter the name of the input, if required.
3. Select the alarm input type, NO (normally open) or NC (normally closed). Default is NO.
4. Check the **Enable Alarm Input** box and click **Actions** to set up the rules for the cameras to be triggered, their alarm schedules, method of alarm notification and PTZ linking function.
5. Select the cameras to be triggered when an external alarm is detected.

In the Actions window, click the **Trigger Channel** tab and then select the cameras to be triggered for recording when an alarm is detected. Click **Apply** to save the settings.

6. Select the arming schedules for the external alarm.

In the *Actions* window, click the **Arming Schedule** tab and select the day of the week and the time periods during the day when alarms can be recorded. You can schedule up to eight time periods in a day. Default is 24 hours.

Click **Apply** to save the settings. Click **Copy** to copy these settings to other days of the week.

**Note:** The time periods defined cannot overlap.

7. Select the response method to an external alarm.

In the *Actions* window, click the **Actions** tab to define the method by which you want the recorder to notify you of the alarm. Select one or more of the five notification types. See “Alarm response actions” below for a description of these alarm notification methods.

Click **Apply** to save the settings.

8. Select the PTZ camera function required in response to an external alarm.

In the Actions window, click the **PTZ Linking** tab. Select the PTZ camera and enter the preset, preset tour or shadow tour that is triggered when the alarm is detected.

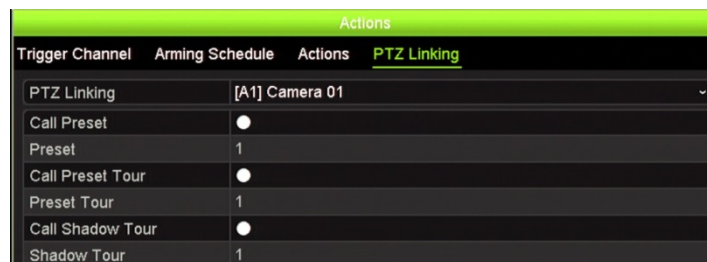

Click **Apply** to save the settings.

9. Click **OK** to return to the alarm input window.
10. Click **Apply** to save all settings.
11. Click **Exit** to return to live view.

## Alarm response actions

When setting up the rules for alarm detection, you can specify how you want the recorder to notify you about an alarm or event. You can select more than one notification type.

Not all alarm response actions are available for all types of alarms.

The alarm response actions are:

- **Full-screen monitoring:** When an alarm is triggered, the monitor (VGA or HDMI) displays an image in live view mode. For alarms that are triggered simultaneously, images display one at a time every 10 seconds (default dwell time). You can set a different dwell time using the “Dwell Time” setting under the Display Settings>Layout window. When the alarm stops, cycling of the images stops and you return to live view mode. This alarm option must be selected for each channel where it is required.
- **Enable Alarm Audio:** Triggers an audible beep when an alarm or event is detected by the system or a camera.
- **Notify Alarm Host:** Sends a signal to TruVision Navigator or other software applications when an alarm or event is detected.
- **Send Email:** Sends an email when an alarm or event is detected. See “Email settings” on page 87 for information on how to configure the recorder to send an email.
- **Trigger Alarm Output:** Triggers an alarm output or multiple alarm outputs when a notification is detected for an external alarm. See “Set up alarm outputs” below for information on configuring an alarm output.

## Set up alarm outputs

You can connect the recorder to an alarm system, such as a siren or intrusion system, which is then activated when an alarm is triggered. You can select how long the alarm signal remains active as well as schedule when alarm outputs can be triggered.

### To set up an alarm output:

1. From the menu toolbar, click **Alarm & Event Setup > Alarm Output**.
2. Select the alarm output.
3. Select a timeout option between 5 and 600 seconds or select “Manually Clear”.

The timeout setting lets you define how long an alarm signal remains active after the alarm has ended. If you select **Manually Clear**, the alarm signal remains active until it is manually acknowledged by pressing the alarm button on the front panel or remote control (see “Manual trigger” on page 99).

4. Select the arming schedules for the alarm output.

Click the **Actions** button and select the day of the week and the time periods during the day when motion can be recorded. You can schedule up to eight time periods in a day. Default is 24 hours.

Click **Apply** to save the settings. Click **Copy** to copy the settings to other days of the week and holiday period.

**Note:** The time periods defined cannot overlap.

5. Click **OK** to return to the alarm output window.

6. Click **Copy** to copy these settings to other cameras, if required, and then click **Apply** to save the changes.
7. Click **Exit** to return to live view.

## Manual trigger

The manual trigger menu allows you to manually trigger outputs of the recorder.

### To trigger or clear alarm outputs manually:

1. From the menu toolbar, click **Alarm & Event Setup > Manual Trigger**.
2. Select the desired alarm output and click the following buttons:
 

**Trigger / Clear:** Trigger an alarm output or stop an alarm output. As there is only one alarm output available, the “Trigger All” button just triggers the one output. However, if an IP camera is connected to the recorder, then the outputs of the camera will also be listed.

**Clear All:** Stop all alarm outputs at once.
3. Click **Exit** to return to live view. The alarm is silenced.
 

- Or -

Press the **Alarm** button on the front panel or remote control. The alarm is silenced.

## Buzzer settings

When an alarm is triggered by the system or a camera, the recorder can be set up to respond with a warning buzzer. You can modify the time during which the warning buzzer sounds for both system and camera alarm. Select **Alarm & Event Setup > Buzzer Settings** and select a buzzer time limit for the system and camera alarms. Select Mute, 5 s, 10 s, 20 s, 30 s, 60 s, 120 s, 240 s, or Constant. Default is Constant.

## Alarm and event notification

You can select the alarm and event notifications to be included in the event hint icon of the alarm center displayed in live view. Clicking the icon opens the window of the alarm center that lists the detected alarm and event notifications. See “Status information” on page 25 for information on the status icon displayed in the OSD.

You can quickly check the system status by looking at the status LEDs on the front panel.

The different types of alarm and event notifications are:

- **HDD Full:** All installed HDDs are full and will not record any more video.

- **HDD Error:** Errors occurred while files were being written to the HDD, there is no HDD installed, or the HDD had failed to initialize.
- **Network Disconnected:** Disconnected network cable.
- **Duplicate IP Address Found:** There is an IP address conflict with another system on the network.
- **Illegal Login:** Wrong user ID or password used.
- **Input/Output Video Standard Mismatch:** I/O video standards do not match.
- **Input/Recording Resolution Mismatch:** The input and recording resolutions do not match.
- **Video Loss:** The video image is lost. Video may be lost if the camera develops a fault, is disconnected, or is damaged.
- **Alarm Input Triggered:** An alarm triggered by an external alarm device (for example, PIR detector, dry contacts...)
- **Camera Tamper Detected:** The camera view has changed. For example, someone has deliberately blocked the camera view by spraying paint on the lens or by moving the camera
- **Motion Detected:** Motion is detected.
- **Abnormal Record:** HDD cannot record any more files. This could be due to the overwrite option being disabled so recorded files are locked and cannot be deleted.
- **IP Camera Conflicted:** Conflict in IP address setting.
- **Resolution or Bitrate of Substream Not Supported**
- **Cross Line Detected:** People, vehicles and objects have been detected crossing a pre-defined line or an area on screen.
- **Perimeter Intrusion Detected:** Someone has been detected entering a pre-defined area in the surveillance scene.
- **Audio Input Exception:** A camera has detected sounds that are above a selected threshold.
- **Sudden Change of Sound Intensity:** A camera has detected a sudden change in the sound intensity.
- **Face Detected:** A camera has detected that a human face is moving towards it.
- **Defocus Detected:** There is image blur caused by defocusing the lens.
- **Sudden Scene Change:** A camera has detected a change in the scene caused by an intentional rotation of the camera.
- **Enter Region Detected:** A camera has detected that an object, such a vehicle, people or other objects, has entered a designated region.
- **Exit Region Detected:** A camera has detected that an object, such a vehicle, people or other objects, has exited a designated region.



- **Leave Behind:** A camera has detected that an object has been left in a designated region, such as baggage.
- **Object Removed:** A camera has detected that an object has been removed from a designated region, such as exhibits on display.
- **Panel Heartbeat Alarm:** This is an intrusion integration event. There is no communication between the intrusion panel and the recorder.
- **Arming Panel Alarm:** This is an intrusion integration event. The intrusion panel has been armed.
- **Disarming Panel Alarm:** This is an intrusion integration event. The intrusion panel has been disarmed.
- **Intrusion Alarm:** This is an intrusion integration event. An intrusion alarm has been triggered by the intrusion panel.

#### To set up event notifications:

1. From the menu toolbar, click **Alarm & Event Setup > Notifications**.
2. Check **Display Event Icon** so that the event icon appears in the OSD in live view when an alarm or event is triggered (default is enabled).
3. Under **Event Hint Settings**, click the Actions button. From the drop-down list, select the desired event notifications to be listed in the alarm center in live view and click **OK**. See “Alarm and event notification” on page 99 for the complete list.
4. Select the event priority: VCA < Motion or VCA > Motion. Default is VCA < Motion, where motion has priority over VCA.
5. Select a technical event notification and how the recorder should respond to it.

Under **Notification Type**, select the desired technical event notification:

- **HDD Full:** All installed HDDs are full and will not record any more video.
- **HDD Error:** Errors occurred while files were being written to the HDD, there is no HDD installed, or the HDD had failed to initialize.
- **Network Disconnected:** Disconnected network cable.
- **Duplicate IP Address Found:** There is an IP address conflict with another system on the network.
- **Illegal Login:** Wrong user ID or password used.
- **Input/Output Video Standard Mismatch:** I/O video standards do not match.
- **Input/Recording Resolution Mismatch:** The input and recording resolutions do not match.
- **Abnormal Record:** HDD cannot record any more files. This could be due to the overwrite option being disabled so recorded files are locked and cannot be deleted.

Check one or more response method: Enable Alarm Audio, Notify Alarm Host, Send Email, and Trigger Alarm Output.

**Note:** The list of response methods available depends on the notification type selected.

6. Repeat step 5 for other notification types.
7. Click **Apply** to save the settings.
8. Click **Exit** to return to live view.

## Video loss

Video may be lost if the camera develops a fault, is disconnected, or is damaged. You can set up the recorder to detect video loss and trigger a system notification.

### To setup video loss detection:

1. From the menu toolbar, click **Alarm & Event Setup > Video Loss**.
2. Select a camera to configure for video loss detection.
3. Check the **Enable Video Loss Alarm** box to enable the feature.
4. Click the **Actions** button to enter the Actions window.
5. Set the arming schedule for detecting video loss.

Click the **Actions** tab and select the schedule of when you want video loss detection to be enabled. The schedule can be set for all week or any day of the week with up to 8 time periods per day. Click **Apply** to save the settings.

6. Select the alarm response method.

Click the **Arming Schedule** tab and select how you want the recorder to notify you of video loss. Select one or more options: Full-screen monitoring, enable alarm audio, notify alarm host, send email, and trigger alarm host. Click **Apply** to save the settings.

7. Click **OK** to return to the main window
8. Click **Copy** to copy these settings to other cameras, if required, and then click **Apply** to save the changes.
9. Click **Exit** to return to live view.

## Alarm host setup

If an alarm host is set, the recorder sends a signal to the host when an alarm is triggered. The remote alarm host must have the TruVision Navigator server software installed.

**To set up a remote alarm host:**

1. From the menu toolbar, click **Alarm & Event Setup > Alarm Host Setup**.
2. Enter Alarm Host IP and Alarm Host Port values.

Alarm host IP represents the IP of the remote PC where the Network Video Surveillance software installed. The alarm host port value must be the same as software's alarm monitor port. Up to three alarm hosts can be set. For each alarm host, the default port is 5001, 5002, and 5003.

3. Click **Apply** to save the settings.
4. Click **Exit** to return to live view.

## Intrusion integration alarm reporting

The recorder includes an alarm receiver software module for intrusion integration. This permits SIA and XSIA events to be reported to the recorder from Interlogix intrusion panels via IP and to be linked to recorder actions.

The following Interlogix panels are supported:

- ATS Master (EMEA only)
- Advisor Advanced (EMEA only)
- NetworX panels

Up to three intrusion panels can be set up in the recorder. Each panel can report up to 32 intrusion zones (a zone is an intrusion panel input).

The panels must support the SIA or XSIA reporting protocol. They can report the following alarm types to the recorder:

- An arming event
- A disarming event
- An alarm event that has an "A" as a second character in the SIA/XSIA code
- A heartbeat alarm

In the intrusion panel set up the recorder as a normal monitoring station. Use OH version 3 so that the data format is understood by the recorder.

**To set up an alarm panel in the recorder:**

1. From the menu toolbar, click **Alarm & Event Setup > Intrusion Panel Setup**.
2. In the Intrusion Panel Setup window, enter the required settings.

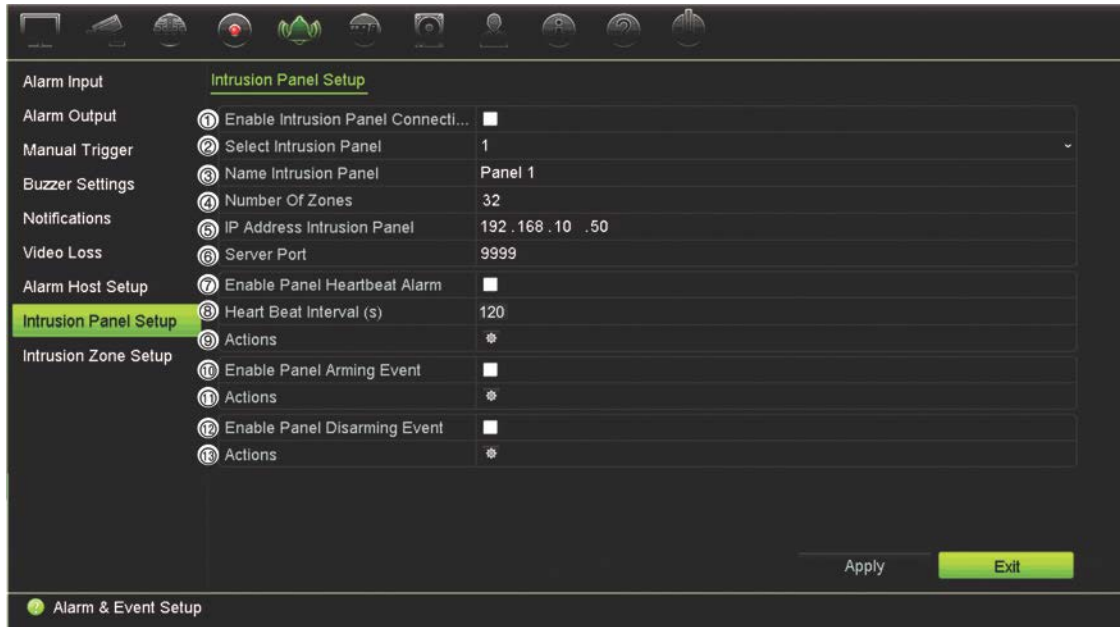

Option	Description
Set up the intrusion panel connection parameters:	
1. Enable Intrusion Panel Connection	Check this box to enable the intrusion panel connection.
2. Select Intrusion Panel	Select which panel you want to set-up. Up to three panels can be set up.
3. Name Intrusion Panel	Enter a name for the panel.
4. Number Of Zones	Up to 32 panel zones can report to the recorder. The number cannot be increased but you can allocate a different ID for each zone under the “Intrusion Zone Setup” menu.
5. IP Address Intrusion Panel	Enter the panel’s IP address. The IP address must be in the same LAN as the recorder.
6. Server Port	Enter the port that is used to report the events. Default is 9999. This port number must match the port number set up in the intrusion panel.
Set up the heartbeat alarm parameters:	
7. Enable Panel Heartbeat Alarm	Check this box to enable the panel heartbeat alarm. The heartbeat alarm will then be reported to the recorder.
8. Heartbeat Interval (s)	Enter the interval between two heartbeats. It is measured in seconds. Default is 120 s. This interval is valid even if the “Enable Panel Heartbeat Alarm” check box is disabled.  To be able to trigger a heartbeat alarm when the heartbeat is not received within this interval, enable the “Enable Panel Heartbeat Alarm” check box.  The recorder heartbeat interval must always be higher than that of the intrusion panel.
9. Actions	Click the icon to set up the actions linked to the panel heartbeat alarm. Go to step 3.

Set up the panel arming event parameters:

Option	Description
10. Enable Panel Arming Event	Check this box to enable the panel arming event. When the panel is armed, it will be reported to the recorder.
11. Actions	Click the icon to set up the actions linked to the panel arming alarm. Go to step 3.
Set up the panel disarming alarm parameters:	
12. Enable Panel Disarming Event	Check this box to enable the panel disarming event. When the panel is disarmed, it will be reported to the recorder.
13. Actions	Click the icon to set up the actions linked to the panel disarming alarm. Go to step 3.

3. To define the actions for the heartbeat, panel arm and panel disarm alarms that are reported by the intrusion panel, click **Action** and each of the tabs:

**Trigger Channel:** Select the cameras that will record when an alarm event is received. The cameras will record following the main stream (alarm) parameters. The recordings will be 10 seconds for each assigned camera.



**Arming Schedule:** Define the alarm schedule for the actions. You can schedule up to eight periods in a day. Default is 24 hours.

**Actions:** Check the required action that needs to be executed when an alarm is received:

- Enable an alarm audio (buzzer)
- Notify the alarm host (supported by TruVision Navigator 7.0)
- Send email
- Trigger an alarm output

**PTZ Linking:** Select the PTZ camera as well as the preset, preset tour, or shadow tour that is triggered when the alarm/event is detected.

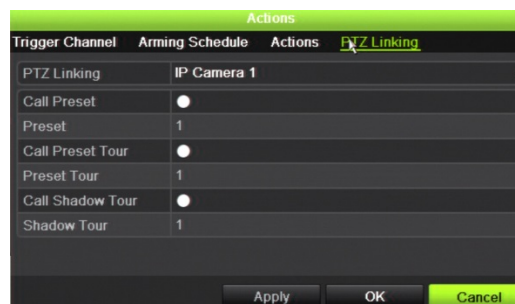

Click **Apply** to save the settings. Click **OK** to return to the main window.

4. Click **Apply** to save the intrusion panel setup parameters.

5. Click **Exit** to return to live view.

**To set up the zones in an alarm panel:**

1. From the menu toolbar, click **Alarm & Event Setup > Intrusion Zone Setup**.
2. Under **Select Intrusion Panel**, select intrusion panel 1, 2 or 3.
3. Select the desired ID of a zone. The maximum is 32. The number does not have to match the zone number.
4. Under **Zone Number**, select the desired zone number. The zone number can be any valid number of the panel, which does not need to match the zone number.
5. Click **Action** to define the actions for the selected zone number.

---

**Trigger Channel:** Select the cameras that will record when an alarm event is received. The cameras will record following the main stream (alarm) parameters. The recordings will be 10 seconds for each assigned camera.

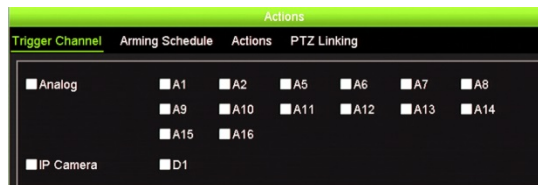

---

**Arming Schedule:** Define the alarm schedule for the actions. You can schedule up to eight periods in a day. Default is 24 hours.

---

**Actions:** Check the required action that needs to be executed when an alarm is received:

- Enable an alarm audio (buzzer)
- Notify the alarm host (supported by TruVision Navigator 7.0)
- Send email
- Trigger an alarm output

---

**PTZ Linking:** Select the PTZ camera as well as the preset, preset tour, and/or shadow tour that is triggered when the alarm/event is detected.

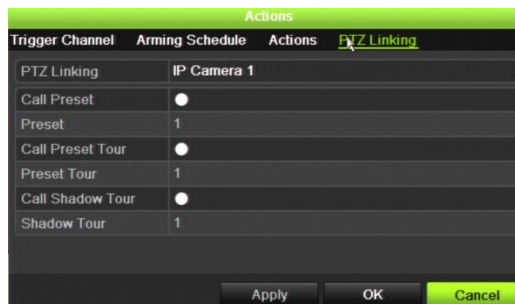

---

Click **Apply** to save the settings. Click **OK** to return to the main window.

6. Click **Apply** to save the intrusion panel setup parameters.
7. Click **Exit** to return to live view.

## TVRMobile push notifications

TVRMobile 2.3 (and higher) can receive events from the recorder.

The 'Push notifications' feature lets TVRmobile notify a user of new messages or events even when the user is not actively using TVRMobile.

In TVRMobile, events can be received from the recorder and these events can be shown as a push notification to the user.

The recorder needs to be connected to the internet to be able to use push notifications. Even when the phone or tablet is used via Wi-Fi on the same LAN as the recorder, an internet connection is required.

### Recorders supporting push notifications

- TVN 10 (FW 2.1)
- TVN 21 (FW 3.1)
- TVN 22 (FW 1.0)
- TVR 12HD (FW 1.2)
- TVR 15HD (FW 1.0)
- TVR 44HD (FW 1.2)

## Set up push notifications

### To set up push notifications in the recorder

1. In the browser or OSD set up an event for the desired camera.
2. In the *Actions* tab, enable **Notify Alarm Host**.
3. Under **Alarm & Event Setup > Alarm Host Setup** leave the destination address empty.
4. Go to **Network Settings > Network Settings**.
5. Enter the DNS, IPv4 Default Gateway settings. Also enter the HTTP port, RTSP service port and Server port settings.
  - HTTP port (default: 80) (\*)
  - RTSP port (default: 554) (\*)
  - Server port (default: 8000)

(\*) Some ISPs block the use of port 80 and/or 554. When these ports are blocked, use a port number higher than 1024.

### To set up push notifications for TVRMobile:

1. In TVRMobile, add the recorder.
2. Enter the DNS and Default Gateway settings.

3. In the menu option **Alarm**, select **Set Alarm Notification**.

The events will be listed in the *Alarm Information* window.

4. Slide the button to the right to enable the push notification function for the recorder.

#### To set up push notifications for TVRMobileHD:

1. In TVRMobileHD, add the recorder.
2. In the menu option **Alarm**, select **Alarm Push Notification**.

The events will be listed in the *Alarm Information* window.

3. Slide the button to the right to enable the push notification function for the recorder.

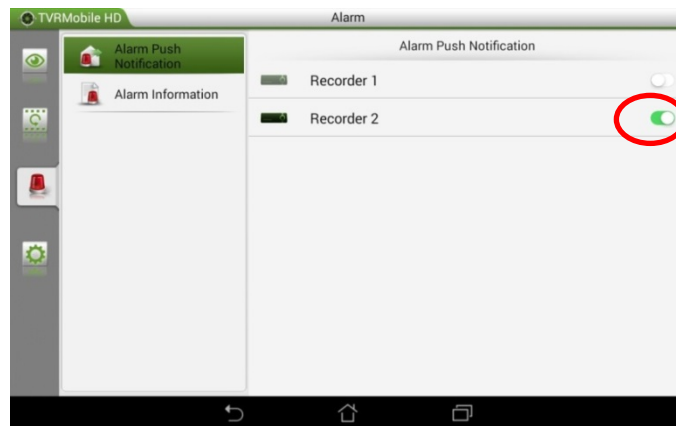

As soon as an event happens, the event will appear in the mobile app and a notification will be shown.

## Display push notifications

#### To display push notifications on TVRMobile:

1. When motion detection is detected, a red dot appears in the left upper corner with the number of triggers that have been detected.

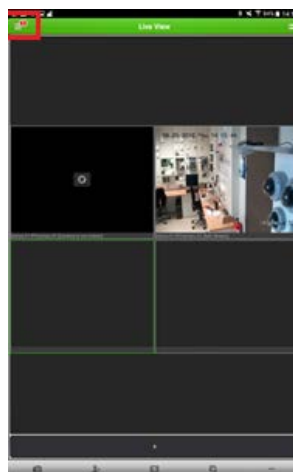

2. Select the red dot and select **Alarm**. A list of events will be displayed.



3. Select the cameras symbol next to an event to view live or recorded video of the event.

#### To display push notifications on TVRMobileHD:

1. When motion detection is detected, a red dot appears on the alarm icon with the number of triggers that have been detected.



2. Select the **Alarm** icon. The Alarm information screen will be shown with the list of alarms.
3. Select the camera symbol next to an event to view live or recorded video of the event.

# Chapter 14

## Device management

This chapter describes how to:

- Set up the time and date of the recorder
- Select the recorder language and set up general system parameters such as the device name, menu timeout period, and enable/disable password requirement
- Import/export configuration files
- Upgrade the firmware
- Set up holiday periods
- Configure RS-232 settings

### Time and date settings

You can set up the date and time that will appear on-screen as well as on time stamped recordings. The start and end time of daylight saving time (DST) in the year can also be set. DST is deactivated by default. See Figure 27 below for the Time settings screen.

Figure 27: Time and Date Settings window



Table 14: Description of the Time and Date Settings window

Option	Description
1. Time Zone	Select a time zone from the list.
2. Date Format	Select the date format from the drop-down list. Default format is DD-MM-YYYY.
3. Time Format	Select either the 12-hour or 24-hour time format from the list. Default format is 24-hour format.
4. Display Week	Check to display the day of the week in the monitor time bar. Check the box to enable/disable. Default is Disabled.
5. System Date	Enter the system date. Default date is the current date.
6. System Time	Enter the system time. Default time is the current time.
7. Auto DST Adjustment	Enable to activate DST is automatically. It depends on the time zone selected. Default is Disabled.
8. Enable DST	Manually define DST. If this option is selected, the <i>Auto DST adjustment</i> option is disabled. Default is Disabled. Click the check box to enable or disable daylight savings time (DST).
From	Enter the start date and time for daylight savings.
To	Enter the end date and time for daylight savings.
DST Bias	Set the amount of time to move DST forward from the standard time. Default is 60 minutes.

## General recorder settings

Use the General Settings menu of Device Management to configure general recorder options.

See Figure 28 below for the general options available. The changes are immediately implemented once Apply is clicked to save the settings.

Figure 28: General Settings of the recorder

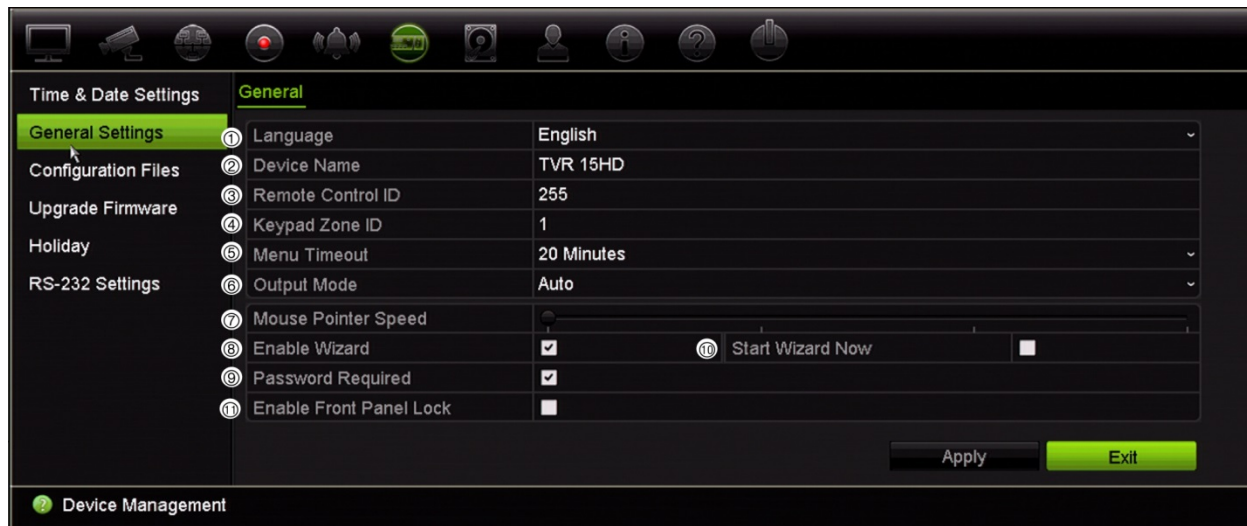

Table 15: Description of the General Settings window

Option	Description
1. Language	<p>Define the language of the system.</p> <p>Select the desired language from the drop-down list and click <b>Apply</b>. The language displayed changes immediately.</p> <p>Default is English.</p>
2. Device Name	<p>Define the recorder name.</p> <p>Click the edit box and enter the new name from the soft keyboard.</p>
3. Remote Control ID	<p>The device number to use for the recorder when linking the device to a remote control. The default value is 255.</p>
4. Keypad Zone ID	<p>The keypad zone ID number.</p>
5. Menu Timeout	<p>Define the time in minutes after which the menu window reverts to live view mode. Select a time from the drop-down list, and click <b>Apply</b>. Menu timeout also applies to the system idle time after which a password will be required.</p> <p>Default value is 5 minutes.</p>
6. Output Mode	<p>Select from Auto, HDMI, and VGA.</p>
7. Mouse Pointer Speed	<p>Modify the speed of the mouse pointer. Adjust the scroll bar point to the desired level and click <b>Apply</b>.</p> <p>Default is the slowest of the four speeds.</p>

Option	Description
8. Enable Wizard	Immediately start the Startup Wizard without rebooting the system. Check the box to enable/disable and click <b>Apply</b> . Default is Enabled.
9. Start Wizard Now	Reboot the system immediately and start the Startup Wizard. Default is Enabled.
10. Password Required	Define whether a login password is required to open the menu. Check the box to enable/disable and click <b>Apply</b> . Default is Enabled.
11. Enable Front Panel Lock	When the system logs out, the front panel is automatically locked. When enabled, to unlock the front panel, press the Live button for 5 seconds. Default is Disabled.

## Configuration files

You can export and import configuration settings from the recorder. This is useful if you want to copy the configuration settings to another recorder, or if you want to make a backup of the settings.

You cannot import a configuration file if the firmware version of the recorder has in the meantime changed.

### Import and export files

Insert an external storage device in the recorder. Go to the **Device Management > Configuration Files** to import or export configuration settings. Click **Export** to export the recorder's configuration settings into an external storage device or click **Import** to import configuration settings after selecting a configuration file from the external storage device.

### Restore default settings

The administrator can reset the recorder to the factory default settings. Network information such as IP address, subnet mask, gateway, MTU, NIC working mode, server port, and default route are not restored to factory default settings.

#### To restore parameters to default factory settings:

1. From the menu toolbar, click **Device Management > Configuration Files**.

**Note:** Only the administrator can restore the default settings.

2. To restore all parameters to default factory settings:

Click the **Default** button. Enter the Admin password, click **OK**, and then click **Yes** to confirm that you want to restore all parameters to default.

— Or —

To restore all parameters, except network settings, to default factory settings:

Click the **Restore** button. Enter the Admin password, click **OK**, and then click **Yes** to confirm that you want to restore all parameters except network settings to default.

3. Click **OK** to confirm you want to restore default settings.  
The system will restart.

## Upgrade system firmware

The firmware on the recorder can be updated using three methods:

- Via a USB device
- Via the recorder web browser
- Using TruVision Navigator. For further information, refer to the TruVision Navigator user manual.

The firmware upgrade file is labeled *TVR15HD.dav*.

### To update the system firmware using a USB device:

1. Download the latest firmware from our web site at:  
[www.interlogix.com](http://www.interlogix.com)
2. Connect the USB device to the recorder.
3. From the menu toolbar, click **Device Management > Upgrade Firmware**.  
The list of files on the USB is displayed.
4. Select the firmware file and click **Upgrade**. Click **Yes** to begin the upgrade process.
5. When the upgrade process is completed, reboot the recorder. The recorder does not reboot automatically.

## Holiday schedules

It is possible to indicate holidays for which you can create a separate recording schedule. Once one or more holidays are created, a separate entry for holiday will be included in the recording schedule (refer to “Recording schedule” on page 92 of the manual)

### To set up a holiday recording schedule:

1. From the menu toolbar, click **Device Management > Holiday**.
2. Select a holiday period from the list and click its **Edit** button to modify the settings. The Edit window appears.
3. Enter the name of the holiday period and click **Enable**.
4. Select whether the holiday period will be categorized by date, week, or month and then enter the start and end dates.
5. Click **Apply** to save the settings and then **OK** to return to the Edit window.
6. Repeat steps 2 to 5 for other holiday periods.
7. Click **Exit** to return to live view.

## RS-232 settings

Use the **Device Management** menu to configure the RS-232 parameters such as baud rate, data bit, stop bit, parity, flow control, and interface.

Figure 29: RS-232 setup window



Table 16: Description of the RS-232 settings window

Option	Description
1. Baud Rate	This is a measure of the speed of data transmission. Default is 115200.
2. Data Bit	A bit is the smallest unit of data in a serial communication message. A data bit is the bit carrying the information, as opposed to the start bit and the stop bit. Default is 8.
3. Stop Bit	Stop bits mark the end of a transmission of a serial communication message. Default is 1.
4. Parity	The method used to detect errors in the number of bits being transmitted. Default is None.

---

<b>Option</b>	<b>Description</b>
5. Flow Ctrl	Flow control is the process by which data transfer is regulated so that it does not arrive too quickly for the receiving process. Default is None.
6. Interface	Select one of the two ways the RS-232 port can be used: <b>Technical Support:</b> Console mode.

---



# Chapter 15

## Storage management

This chapter describes the content of the Storage Management menu, including HDD information, storage mode, S.M.A.R.T. settings as well as bad sector detection.

### HDD status information

You can check the status of any of the installed HDDs on the recorder at any time.

#### To check the status of a HDD:

1. From the menu toolbar, click **Storage Management > HDD Information**.
2. Note the status of the HDDs listed under the Status column.

If the status is listed as Normal or Sleeping, the HDD is in working order. If it is listed as Abnormal and has already been initialized, the HDD needs to be replaced. If the HDD is Uninitialized, you need to initialize it before it can be used in the recorder. Refer to “Initializing HDDs” above for more information.

**Note:** The status information is also shown in the **System Information > HDD** window.

### Initialize a HDD

The built-in HDD does not need to be initialized before it can be used. You can also re-initialize the HDD. However, all data on the HDD will be destroyed.

#### To initialize a HDD:

1. From the menu toolbar, click **Storage Management > HDD Information**.
2. Under the *HDD Information* tab, select the HDD to be initialized.
3. Click the **Initialize** button to begin initialization.

After the HDD has been initialized, the status of the HDD changes from Abnormal to Normal.

## Overwrite a HDD

You can select how the recorder responds when the HDDs become full and there is no longer sufficient space to save new data. The overwrite option is enabled by default.

### To enable overwrite when the HDDs are full:

1. From the menu toolbar, click **Storage Management > HDD Information**.
2. Enable **Overwrite**.

---

**Caution:** If the overwrite option is disabled and the quota management capacity for a channel is set to zero, the recordings on that channel can still be overwritten. To avoid this happening, set a quota level for the channel or use the group management mode.

---

3. Click **Apply** to save the settings.
4. Continue to configure the recorder or click **Exit** to return to live view.

## Add a HDD

You can add additional network-attached hard drives to setup a NAS or SAN system.

### To add a HDD:

1. From the menu toolbar, click **Storage Management > HDD Information**.
2. Click the **Add** button to begin.
3. Select a **Network Storage** name.
4. Select the network storage type. Select from NAS or IP SAN.

**Note:** Only NAS with NFS version 3.0 or higher is supported. The NAS must be able to be used without login credentials.

5. Enter the HDDs Storage IP address. Click the **Search** button to search for the Storage Directory.
6. Click the **OK** button to create the selected network attached storage.

## Storage mode

To ensure an efficient use of the storage space available on HDDs, you can control an individual camera's storage capacity using HDD quota management. This function lets you allocate different storage capacities for both recordings and snapshots to each camera.

**Note:** If the overwrite function is enabled, the maximum capacity for both recordings and snapshots is set to zero by default.

### To set the HDD quota for a camera:

1. From the menu toolbar, click **Storage Management > Storage Mode**.



2. Under the Mode option, select **Quota**.
3. Select a camera whose storage capacity you want to change and enter the values in GB for the maximum record capacity and snapshot capacities. The available quota space available is displayed on screen.
4. Click **Apply** to save the settings.
5. If you want to copy these values to other cameras, click **Copy** and select each camera individually. Click **OK**. Click **Apply** to save the settings.

## Group HDDs

This is only valid for eight and 16-channel recorders.

Your recorder can organize multiple HDDs into groups. Videos from specified channels can be set to be recorded onto a particular HDD group. You could, for example, save the records from a couple of high priority cameras to one HDD, and save the recordings from all the other cameras to another HDD.

### To set up an HDD group:

1. From the menu toolbar, click **Storage Management > Storage Mode**.
  2. Under **Mode**, select **Group**.
  3. Under **Record on HDD Group**, select a number for the HDD group.
  4. Check the channels to be added to this group.
- Note: By default, all channels belong to HDD group 1.
5. Click **Apply** to save the settings.

A pop-up window will appear asking to reboot the system. Click **Yes**.

6. Change the HDD status property of the selected HDD. See “Change the HDD status property” below.

## Change the HDD status property

If you have more than one HDD installed, you can change the behavior of a HDD by changing its property. It can be set to read-only or read/write (R/W). The storage mode must be set to *Group* before setting the HDD property.

A HDD can be set to read-only to avoid important recorded files from being overwritten when the HDD becomes full.

### To change a HDD status property:

1. From the menu toolbar, click **Storage Management > HDD Information**.
2. Select the HDD whose property you want to change.
3. Click the **Edit** icon . The **Local HDD Settings** window appears.

**Note:** The Edit icon is only available if there are at least two HDDs installed.

4. Click the desired HDD property for the selected HDD: R/W, Read Only, or Redundancy.
5. Click the group number for this HDD.
6. Click **Apply** to save and exit the window.

**Note:** Once set to read-only, the HDD cannot be used to save recorded files until it is set back to read/write (R/W). If the HDD that is currently being written to is set to read-only, the data is then recorded to the next HDD. If there is only one HDD present, setting it to read-only means the recorder cannot record.

## Set up HDD sleep mode

You can set the HDD to enter standby mode, or sleep mode, after a period of inactivity. Sleep mode decreases the power consumption of a HDD.

### To enable HDD sleep mode:

1. From the menu toolbar, click **Storage Management > Storage Mode**.
2. Check **Enable HDD Sleeping** to enable sleep mode. Default is Enabled.
3. Click **Apply** to save the settings.
4. Continue to configure the recorder or click **Exit** to return to live view.

## S.M.A.R.T. settings

S.M.A.R.T. (Self-Monitoring, Analysis and Reporting Technology) reports on a variety of hard drive attributes. It helps ensure that the HDD is functioning properly at all times while protecting video stored on the hard drive.

To view the S.M.A.R.T. information of a HDD:

1. From the menu toolbar, click **Storage Management > S.M.A.R.T. Settings**.
2. Select the HDD whose data you want to see. A detail listing of S.M.A.R.T. information is displayed.



3. If you want to continue to use a HDD when the S.M.A.R.T. test has failed, check the box **Use when the disk has failed to self-evaluate**. Click **Apply** to save the settings.
4. Click **Exit** to return to live view.

## Bad sector detection

You can improve the performance of your HDDs by ensuring that they have no bad sectors. Bad sectors can slow down an HDD when reading or writing data, for example.

Figure 30: Bad sector detection window

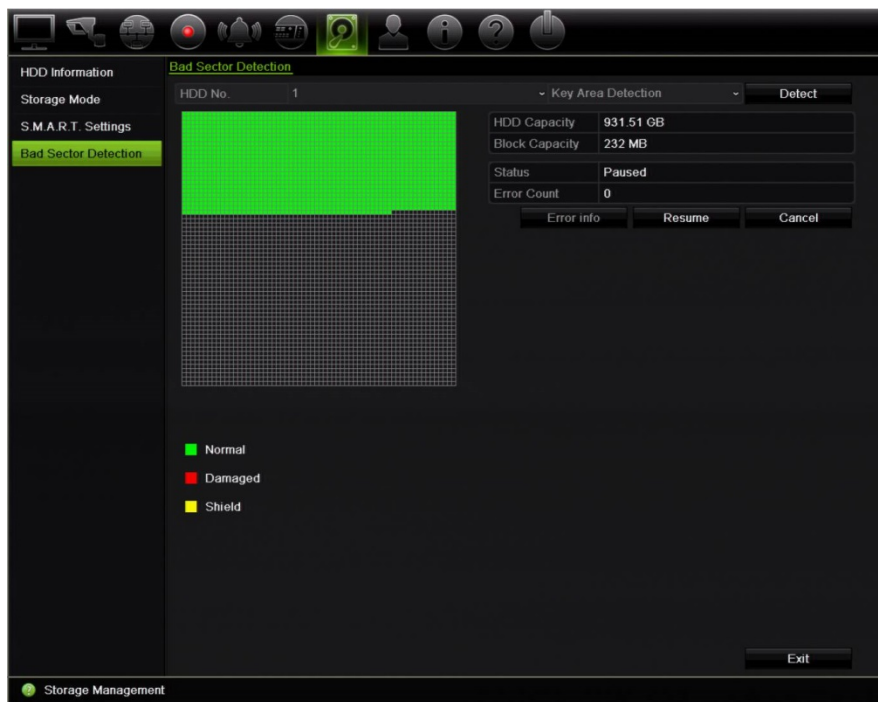

### To detect bad sectors:

1. From the menu toolbar, click **Storage Management > Bad Sector Detection**.
2. Select the HDD you want to test.
3. Select whether you want to do a key area detection or a full detection, and click **Detect**.
4. The system checks the HDD. The color-coded result is displayed on screen. If there are bad sectors found, click **Error Info** to see a list of the errors found.
5. If required, click **Pause** to pause the test or **Cancel** to cancel it.
6. Click **Exit** to return to live view.

# Chapter 16

## User management

### Add a new user

Only a system administrator can create a user. You can have a maximum of 16 users (the administrator as well as operators and guests).

#### To add new users:

1. From the menu toolbar, click **User Management**.
2. Click **Add** to enter the Add User window.
3. Enter the new user's name and password. Both the user name and password can have up to 16 alphanumeric characters.
4. Select the new user's access level: Operator or Guest. Default is Guest.
5. Enter the user's MAC address to let the user access the recorder from a remote computer with this MAC address.
6. Click **OK** to save the settings and return to the previous window.
7. Define the user's permissions.

Click the **Permission** button  for the new user. In the *Permissions* pop-up window check the required access privileges for local, remote and camera configuration. See "Customizing a user's access privileges" below for the permission descriptions for each group.

Click **Apply** to save the settings and **OK** to return to the previous window.

8. Click **Exit** to return to live view.

## Customize a user's access privileges

Only an administrator can allocate access privileges to Operator and Guest users. The access privileges can be customized for each user's needs. The administrator's access privileges cannot be changed.

There are three types of privilege settings: Local Configuration, Remote Configuration, and Camera Configuration.

**Note:** Only the administrator can restore factory default settings.

## Local configuration settings

By default, only the local information (log) management setting is enabled for both operators and guests.

- **Local Information (Log) Management:** Search and view logs of the recorder and view system information.
- **Local Parameter Settings:** Configure parameters and import the configuration from the recorder.
- **Local Camera Management:** Locally add, delete, and edit IP cameras.
- **Local Advanced Operation:** Access HDD management (including the initialization and modification of disk properties). Update system firmware as well as stop the I/O alarm output.
- **Local Shutdown/Reboot:** Shutdown or reboot the recorder.

## Remote configuration settings

By default, only remote log search and two-way audio are enabled for operators, and only the remote log search is enabled for guests.

- **Remote Log Search:** Remotely view logs that are saved on the recorder.
- **Remote Parameter Settings:** Remotely configure parameters and import configuration.
- **Remote Camera Management:** Remotely enable and disable channels.
- **Remote Video Output Control:** For future use.
- **Two-Way Audio:** Use bi-directional audio between the remote client and the recorder.
- **Remote Alarm Control:** Remotely alert or control the relay output of the recorder. Alarm and notification settings must be configured properly to upload to host.



- **Remote Advanced Operation:** Remotely manage HDDs (initializing and setting properties for HDDs) as well as remotely update system firmware and clear the I/O alarm output.
- **Remote Shutdown/Reboot:** Remotely shutdown or reboot the recorder.

## Camera configuration settings

By default, all analog cameras are enabled for operators for each of these settings. By default, the analog cameras are only enabled for local playback and remote playback for guests. IP cameras cannot be configured.

- **Local Playback:** Locally play recorded files that are on the recorder.
- **Local Manual Operation:** Locally start/stop manual recording on any of the channels, snapshots, and video clips.
- **Local PTZ Control:** Locally control PTZ dome cameras.
- **Local Video Export:** Locally back up recorded files from any of the channels.
- **Remote Live View:** Remotely select and view live video over the network.
- **Remote Playback:** Remotely play and download recorded files that are on the recorder.
- **Remote Manual Operation:** Remotely start/stop manual recording on any of the channel.
- **Remote PTZ Control:** Remotely control PTZ dome cameras.
- **Remote Video Export:** Remotely backup recorded files from any channel.
- **Remote Video Download:** Remotely download video.

### To customize a user's access privileges:

1. Click the **User Management** icon in the menu toolbar to display its window.
2. Click the Permission button  for the user whose access privileges need to be changed. The *Permissions* pop-up window appears.
3. Click **Apply** to save the settings.
4. Click the **OK** button to return to the previous window.
5. Click **Exit** to return to live view.

## Delete a user

Only a system administrator can delete a user.

**To delete a user from the recorder:**

1. Click the **User Management** icon in the menu toolbar to display its window.
2. Click the **Delete** button  for the user to be deleted.
3. Click **Yes** in the pop-up window to confirm deletion. The user is immediately deleted.
4. Click **Exit** to return to live view.

## Modify a user

A user's name, password, access level and MAC address can be changed. Only a system administrator can modify a user.

**To modify a user:**

1. Click the **User Management** icon in the menu toolbar to display its window.
2. Click the **Edit** button  for the user whose details need to be changed. The *Edit User* pop-up window appears.
3. Edit the user information and click **OK** to save the settings and return to the previous window.
4. Click **Exit** to return to live view.

## Change the Admin password

The administrator's password can be changed in the **User Management** menu.

**To change the admin password:**

1. Click the **User Management** icon in the menu toolbar to display its window.
2. Click the **Edit** button  for admin. The *Edit User* pop-up window appears.
3. Edit the current admin password and check the **Change Password** box.
4. Enter the new admin password and confirm it. Change the admin MAC address, if required. Click **OK** to save the settings and return to the previous window.
5. Click **Exit** to return to live view.

# Chapter 17

## System information

### View system information

**To view system information:**

1. From the menu toolbar, click **System Information**.
2. To view device information, click **Device Info**.

You can view the device name, model, serial number, firmware version, and encoding version. The QR code for the recorder is also displayed.

You can quickly enter the recorder parameters into TVRMobile by scanning the QR code.

**Note:** The TVRMobile app must first be installed on your smart phone before scanning the recorder QR code.

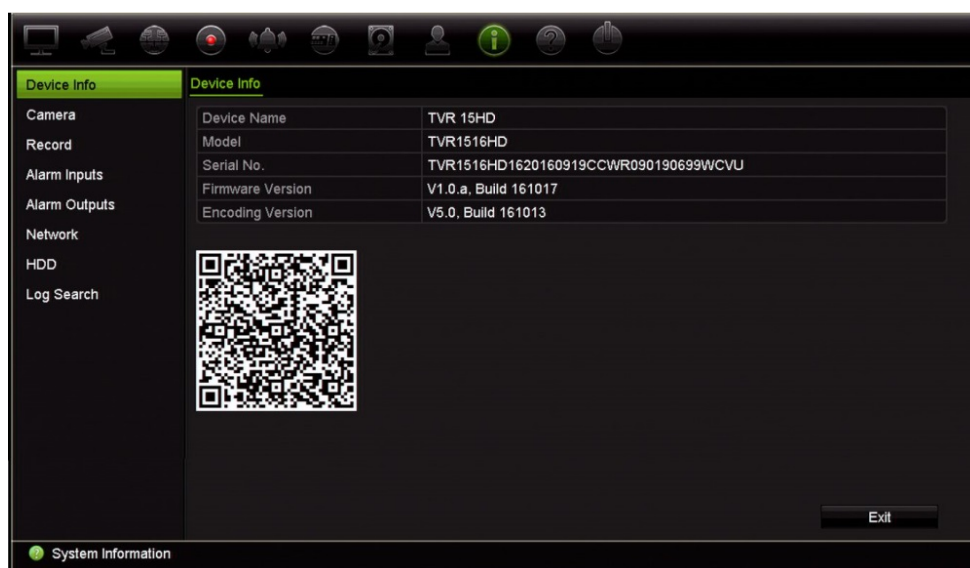

3. To view camera information, click **Camera**.

You can view the information on each camera: camera number, camera name, status, motion detection, tamper proof, video loss, preview link sum, and preview link information.

Preview link sum shows the amount of rote applications that are streaming video from this video channel. Preview link information shows you the IP addresses that are currently connected to this channel.



4. To view record information, click **Record**.

You can view the camera number, recording status, stream type, frame rate, bit rate (Kbps), resolution, record type, active schedule.

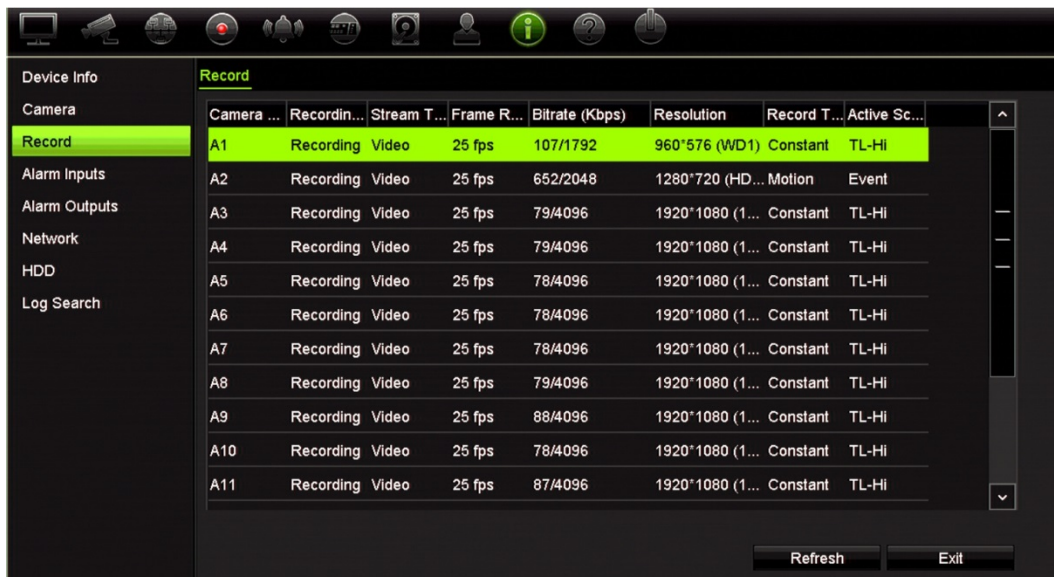

5. To view alarm input information, click **Alarm Inputs**.

You can view the alarm input number, alarm name, alarm type, alarm status, and the triggered camera.



6. To view alarm output information, click **Alarm Outputs**.

You can view the alarm output number, alarm name, and alarm status.

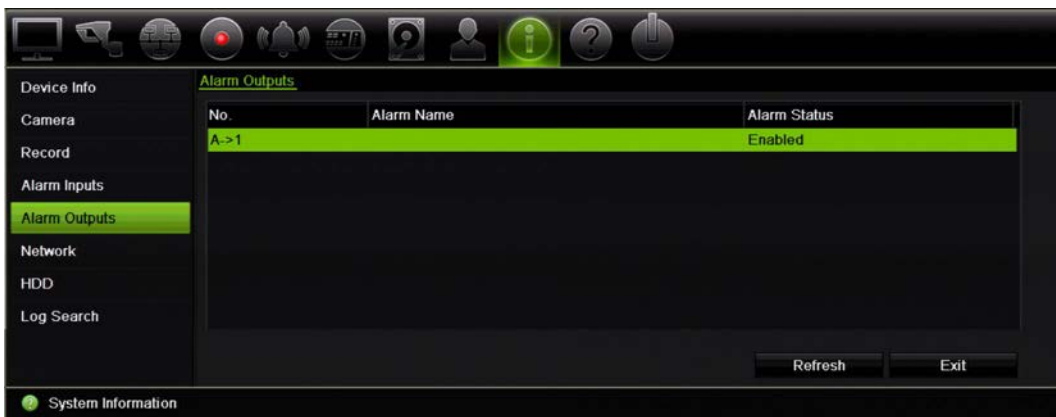

7. To view network information, click **Network**.

You can view the IPv4 address, IPv4 subnet mask, IPv4 default gateway, IPv6 address 1, IPv6 address 2, IPv6 default gateway, MAC address, preferred DNS server, alternate DNS server, enable DHCP, and enable PPPoE,

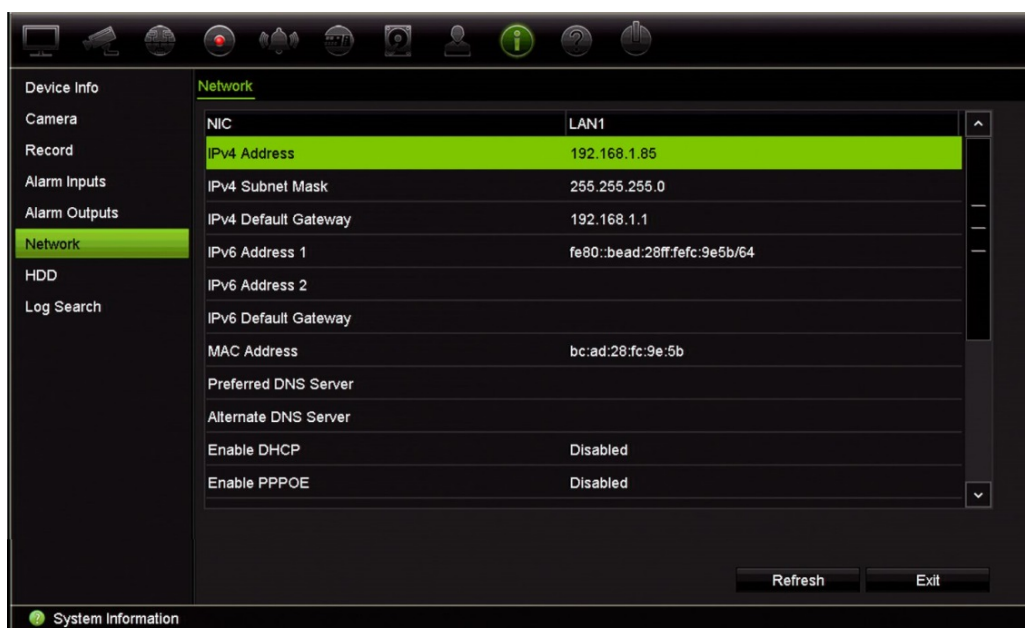

- To view HDD information, click **HDD**.

You can view the HDD label, status, capacity, free space, property, type, and group. The recorded time (how many days we have recordings on the HDD) is also shown.



- Click **Exit** to return to live view.

## Search the system log

Many events of the recorder, such as operation, alarm, information, and notification are logged into the system logs. They can be viewed and exported at any time.

Up to 2000 log files can be viewed at once.

Log files can also be exported onto a USB device. The exported file is named according to the time it was exported. For example: 20160729124841logBack.txt.

**Note:** Connect the backup device, such as a USB flash drive, to the recorder before commencing the log search.

### To search video from the system log:

- From the menu toolbar, click **System Information > Log Search**.
- Select the search start and end date and times.
- Under **Event**, select an option from the drop-down list: All, Alarm, Notification, Operation, or Information.
- From the **Type** list, select one of the options:

Event	Type
All	All
Alarm	All, Alarm Input, Alarm Output, Start Motion Detection, Stop Motion Detection, Start Camera Tamper, Stop Camera Tamper, Cross Line Alarm Started, Cross Line Alarm Stopped, Perimeter Intrusion Alarm Started, Perimeter Intrusion Alarm Stopped, Audio Input Exception Alarm Started, Audio Input Exception Alarm Stopped, Sudden Change of Sound Intensity Alarm Started, Sudden Change of Sound Intensity Alarm Stopped, Face Detection Alarm Started, Face Detection Alarm Stopped, Defocus Detection Alarm Started, Defocus Detection Alarm Stopped, Sudden Scene Change Alarm Started, Sudden Scene Change Alarm Stopped, Enter Region Alarm Started, Enter Region Alarm Stopped, Exit Region Alarm Stopped, Exit Region Alarm Stopped, Object Left Behind Alarm Started, Object Left Behind Alarm Stopped, Object Removed Alarm Started, Object Removed Alarm Stopped, Intrusion Arming Panel Event Started, Intrusion Arming Panel Event Stopped, Intrusion Event Alarm Start, Intrusion Panel Heartbeat Alarm Start, Intrusion Disarming Panel Event Start, Intrusion Disarming Panel Event Stop
Notification	All, Video Loss Alarm, Abnormal Video Signal, Illegal Login, HDD Full, HDD Error, Duplicate IP Address Found, Network Disconnected, Abnormal Record, IP Camera Disconnected, IP Camera Address Conflicted, Input/Output Video Standard Mismatch, IP Camera Access Exception, Record Buffer Overflow, IP Camera Motion Analysis Exception, Input/Recording Resolution Mismatch
Operation	All, Power Up, Local: Shutdown, Abnormal Shutdown, Watchdog Reboot, Local: Restart, Local: Login, Local: Logout, Local: Configure Parameters, Local: Upgrade, Local Operation: Restore Defaults, Local Operation: Factory Defaults, Local: Start Manual Recording, Local: Stop Manual Recording, Local: PTZ Control, Local: Lock File, Local: Unlock File, Local: Trigger Alarm Output, Local: Initialize HDD, Local: Add IP Camera, Local: Delete IP Camera, Local: Set IP Camera, Local: Upgrade IP Camera Firmware, Local: Import IP Camera File, Local: Export IP Camera File, Local: Playback by File, Local: Playback by Time, Local: Playback by Snapshot, Local: Export Config File, Local: Import Config File, Local: Export Record File, Local: Snapshot File, Local: Add Network Storage, Local: Delete Network Storage, Local: Set Network Storage, Local: Restore Admin's Password, Local: Operate Bookmark, Local: Switch Output, Local: HDD Detect, Local: Delete HDD, Local: Configure SNMP, Local Operation: Export People Counting File, Quick Snapshot, Remote: Shutdown, Remote: Reboot, Remote: Login, Remote: Logout, Remote: Configure Parameters, Remote: Upgrade, Remote Operation: Restore Defaults, Remote Operation: Factory Defaults, Remote: Start Manual Recording, Remote: Stop Manual Recording, Remote: PTZ Control, Remote: Lock File, Remote: Unlock File, Remote: Trigger Alarm Output, Remote: Initialize HDD, Remote: Add IP Camera, Remote: Delete IP Camera, Remote: Set IP Camera, Remote: Upgrade IP Camera Firmware, Remote: Import IP Camera File, Remote: Export IP Camera File, Remote: Playback by File, Remote: Playback by Time, Remote: Download by File, Remote: Download by Time, Remote: Export Config File, Remote: Import Config File, Remote: Export Record File, Remote: Export Snapshot File, Remote: Get Parameters, Remote: Get Working Status, Connect Transparent Channel, Disconnect Transparent Channel, Start Two-way Audio, Stop Two-way Audio, Remote: Alarm Arming, Remote: Alarm Disarming, Remote: Add Network Storage, Remote: Delete Network Storage, Remote: Set Network Storage, Remote: Operate Bookmark, Remote: Delete HDD, Remote: Configure SNMP
Information	All, Local HDD Information, HDD S.M.A.R.T., Start Recording, Stop Recording, Delete Expired Video File, Network Storage Information, System Running Status

5. Click the **Search** button. A list of results appears.





6. Select a file and click:

- **Details:** Displays information on the log or recording. For a recording, it lists such information as start time, type of event, local user, host IP address, parameter type, camera number, and gives a description on the types of events recorded and when record time was stopped.

- **Play:** Click to start playback of the selected recording.

- **Export:** Click to archive the selected file to a USB device. The export window appears.

7. Click **Exit** to return to live view.



# Chapter 18

## Using the web browser

This chapter describes how you can use the web browser interface to configure the device, play back recorded video, search through event logs, and control a PTZ dome camera. You can also specify settings on the web browser interface to optimize video playback and recording performance when operating in a low or limited bandwidth environment. Many of the browser configurations are similar to those done locally.

### Internet Explorer users

Internet Explorer for Windows operating systems have increased security measures to protect your PC from any malicious software being installed. When using the recorder web browser interface, you can install ActiveX controls to connect and view video using Internet Explorer.

To have complete functionality of the web browser interface and the recorder player with Internet Explorer, do the following:

- Run the Browser interface and the recorder player application as an administrator in your workstation
- Add the recorder's IP address to your browser's list of trusted sites

#### **To add the recorder's IP address to Internet Explorer's list of trusted sites:**

1. Open Internet Explorer.
2. Click **Tools**, and then **Internet Options**.
3. Click the Security tab, and then select the Trusted Sites icon.
4. Click **Sites**.
5. Clear the "Require server verification (https:) for all sites in this zone" box.
6. Enter the IP address or DDNS name in the "Add this website to the zone" field.
7. Click **Add**, and then click **Close**.
8. Click **OK** in the Internet Options dialog box.
9. Connect to the recorder for full browser functionality.

## Access the web browser

To access the recorder, open the Microsoft Internet Explorer web browser and enter the IP address assigned to the recorder, as a web address. On the logon window, enter the user ID and password.

**Note:** Only one recorder can be viewed per browser.

The default values for recorder network settings are:

- IP address - 192.168.1.82
- Subnet mask - 255.255.255.0
- Gateway address - 192.168.1.1
- Server port: 8000
- Ports:

When using the browser:

RTSP port: 554

HTTP port: 80

When using TruNav:

RTSP port: 554

Server/Client software port: 8000

For more information on port forwarding, see Appendix C “Port forwarding information” on page 148.

## HTTPS settings

Using HTTPS (Hypertext Transfer Protocol Secure) is a secure protocol that provides authenticated and encrypted communication. It ensures that there is a secure private channel between the recorder and cameras

You can create self-signed server certificates as well as request certified server certificates to ensure your network security.

### To create a certificate:

1. Go to **Configuration > Network Settings > HTTPS** of the browser.
2. Click “**Create Self-Signed certificate**”.
3. Type in the country, hostname/IP address, and days of validity (there are more parameters, but you don't need to add anything to them).
4. Click **OK**.
5. Check “**Enable HTTPS**”.

This only works if you enter the address in the browser as HTTPS (as in `https://192.168.1.70`).

6. Click through the warning you get on the browser.

**Buy a certificate:**

1. Go to the **Configuration > Network Settings > HTTPS** section of the browser.
2. Click **“Create Certificate Request”** and fill out the parameters that appear.
3. Click **OK**.
4. Click **“Download”** next to the request that you just created in the browser, and get a .csr file.
5. Visit a site like <https://www.startssl.com/?app=1> and upload your .csr file to get a trusted certificate.

For larger companies, a corporate certificate might be available from the IT department.





## Web browser live view





The recorder web browser lets you view, record, and play back videos as well as manage all aspects of the recorder from any PC with Internet access. The browser's easy-to-use controls give you live view to all the recorder functions. See Figure 31 on page 136.

Figure 31: Live view in the web browser interface



Table 17: Description of live view in the web browser

Name	Description
1. Camera	Select the camera.
2. Menu toolbar	Lets you do the following: <ul style="list-style-type: none"> <li>• View live video</li> <li>• Play back video</li> <li>• Search for event logs</li> <li>• Configure settings</li> <li>• Log out of the interface</li> </ul>
3. Viewer	View live or playback video.
4. Display format	Define how you want video to be displayed in the viewer: Multiview or full-screen.
5. Video function toolbar	Lets you do the following in live view: <ul style="list-style-type: none"> <li> Switch between mainstream and substream.</li> <li> Start/stop all streaming from selected cameras.</li> <li> Start recording from selected cameras.</li> <li> Digital zoom.</li> <li> Take a video snapshot.</li> </ul>

Name	Description
	 View previous and next camera respectively.
	 If viewing in multiview format, live view moves to the next group of cameras for the selected number of video tiles.
	 Turn audio on/off
	 Turn microphone on/off
6. Alarm Trigger Output	 Turn Alarm Output on/off
7. PTZ panel	Hide/display the PTZ panel.

## Control a PTZ dome camera via the web browser

The web browser interface lets you control the PTZ functions of a dome camera. Click a PTZ dome camera and use the PTZ controls on the interface to control the PTZ functions.

Figure 32: PTZ controls

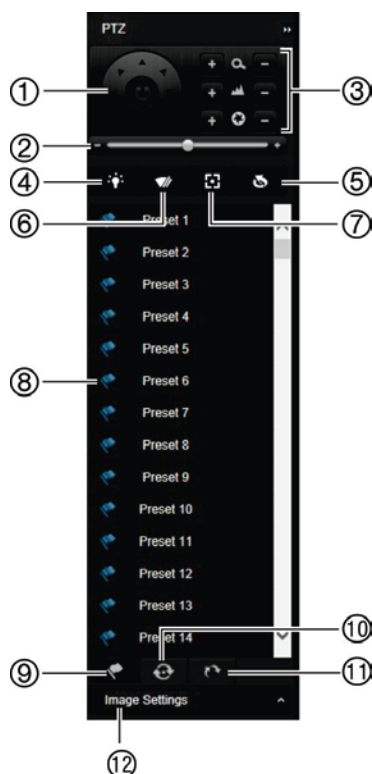

1. Directional pad/auto-scan buttons: Controls the movements and directions of the PTZ. Center button is used to start auto-pan by the PTZ dome camera.
2. Adjust speed of PTZ dome camera.
3. Adjust zoom, focus, and iris.
4. Turn on or off the camera light (if available on the camera).
5. Lens initialization: Initialize the lens of a camera with a motorized lens, such as PTZ or IP cameras. This function helps to maintain lens focus accuracy over prolonged periods of time.
6. Start or stop camera wiper (if available on the camera).
7. Auxiliary focus: Automatically focus the camera lens for the sharpest picture.
8. Start selected preset/tour/shadow tour (depending on function selected).
9. List presets available.
10. List preset tours available.
11. List shadow tours available.
12. Modify brightness, contrast, saturation, and hue values.





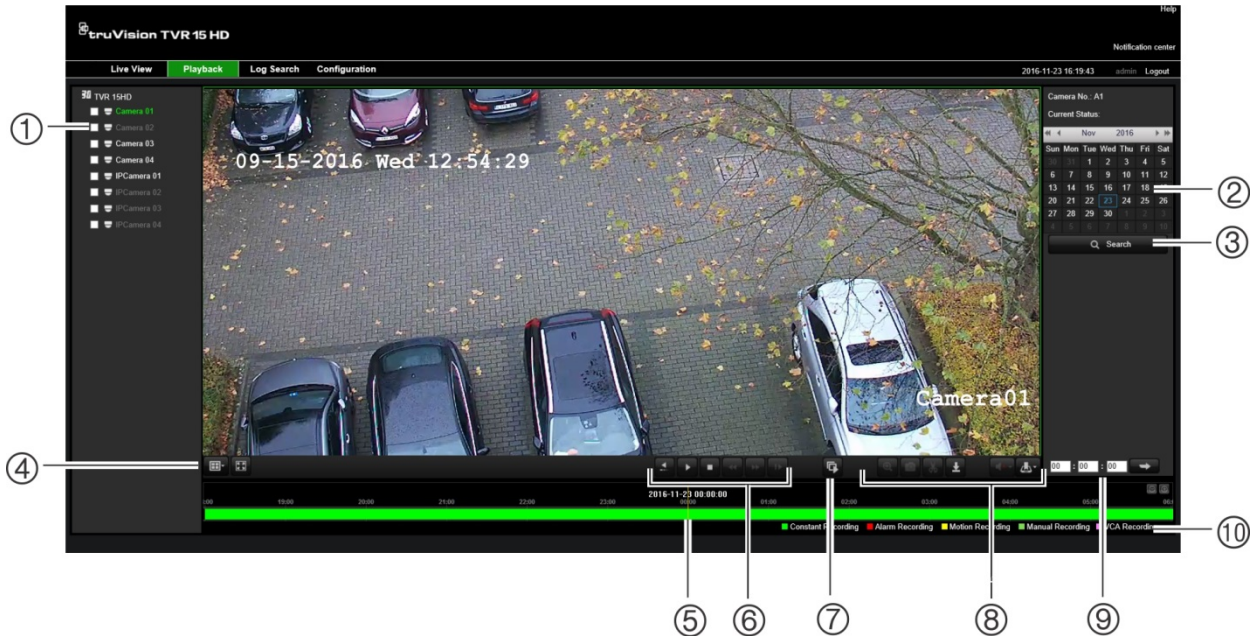

## Play back recorded video







To search and play back recorded video, click Playback on the menu bar to display the Playback page shown in Figure 33 below.

Figure 33: Browser playback page



### Description

1. Selected camera.
2. **Calendar:** Selected day is highlighted.
3. **Search:** Click to start searching recorded files for the selected camera.
4. **Display format:** Click to change the display format in the viewer: single view or multiview display.
5. **Timeline:** The timeline moves left (oldest video) to right (newest video). Click a location on the timeline to move the cursor to where you want playback to start.
6. **Playback control toolbar:**
  -  **Reverse:** Click to reverse playback.
  -  **Start/stop:** Start or stop playback.
  -  **Stop playback.** Timeline jumps back to 00:00:00 time (midnight) of the previous day.
  -  **Speed down:** Click to scroll through the different speeds available: single frame, 1/8 speed, 1/4 speed, 1/2 speed, normal, X2 speed, X4 speed, X8 speed, maximum speed. Current speed is displayed under the camera name on top right of window.
  -  **Speed up:** Click to scroll through the different speeds available: single frame, 1/8 speed, 1/4 speed, 1/2 speed, normal, X2 speed, X4 speed, X8 speed, maximum speed. Current speed is displayed under the camera name on top right of window.
  -  **Single frame:** Click to play back one frame at a time.
7.  **Stop streaming:** Stop streaming from all cameras.

Description	
8.	<b>Audio and video control toolbar:</b>
	<b>Digital Zoom.</b> Access digital zoom. See “Digital zoom in playback” on page 50 for further information.
	<b>Snapshot:</b> Capture a snapshot of the video.
	<b>Video clips:</b> Start/stop video clip during playback. Sections of a recording can be saved to an external storage device.
	<b>Download:</b> Download video clips.
	<b>Backup:</b> Click to make back up of recorded files to save locally on the recorder. A list of the recorded files appears
	<b>Audio:</b> Click to enable/disable audio.
	<b>Bookmark management:</b> Manage bookmarks.
9.	<b>Jump start:</b> Enter a precise time in the box and click the <b>Go To</b> button to jump start the playback to this selected time.
10.	<b>Type of recording:</b>
	<b>Dark green:</b> Indicates video recorded based on the recording schedule defined.
	<b>Red:</b> Indicates video recorded triggered by an alarm event.
	<b>Yellow:</b> Indicates video recorded triggered by motion detection.
	<b>Pale green:</b> Indicates manually recorded video.
	<b>Magenta:</b> Indicates VCA recording.

Select a camera and a day to search from on the calendar displayed, and then click Search. The timeline below the page indicates video recorded for the specified day. The timeline also classifies by color the type of recording with each type.

Click and drag the marker across the timeline on where you want video playback to begin, and then click Play on the playback control toolbar. You can capture a snapshot of a video image, save the video playback, or download the recorded video.

## Search for event logs

The recorder compiles a log of events, such as the start or end of video recording, recorder notifications, and alarms, through which you can easily search. Logs are categorized by the following types:

- **Alarm:** Includes motion detection, tamper detection, video tampering, and other alarm events
- **Notifications:** Includes system notifications such as video loss, HDD failures, and other system-related events
- **Operations:** Includes users access to the web interfaces and other operational events



- **Information:** Includes general information on the recorder actions, such as the start and end of video recording, etc.

To search for logs, click Log on the menu bar, select a log type, specify a date and time range, and then click Search. See Figure 34 below for an example of the results of a log search. For further information on searching and viewing logs, go to “Search the system log” on page 130.

Figure 34: Results of a log search

No.	Log Time	Event	Type	Camera/Alarm/HDD No.	Local/Remote User	Remote Host IP
1	2016-11-23 12:21:28	Operation	Local Logout		admin	0.0.0.0
2	2016-11-23 12:04:57	Operation	Remote Play Back by Time	A1		0.0.0.0
3	2016-11-23 11:36:13	Operation	Local Login		admin	0.0.0.0
4	2016-11-23 11:35:57	Operation	Local Logout		admin	0.0.0.0
5	2016-11-23 11:19:57	Operation	Local Playback By Time	A1	admin	0.0.0.0
6	2016-11-23 11:19:47	Operation	Local Playback By Time	A1	admin	0.0.0.0
7	2016-11-23 11:19:23	Operation	Local Playback By Time	A1	admin	0.0.0.0
8	2016-11-23 11:18:43	Operation	Local Configure Parameters	A1	admin	0.0.0.0
9	2016-11-23 11:18:38	Operation	Local Configure Parameters	A1	admin	0.0.0.0
10	2016-11-23 11:18:38	Operation	Local Configure Parameters	A1	admin	0.0.0.0
11	2016-11-23 11:18:38	Operation	Local Configure Parameters	A1	admin	0.0.0.0
12	2016-11-23 11:18:23	Operation	Local Configure Parameters	A1	admin	0.0.0.0
13	2016-11-23 11:18:23	Operation	Local Configure Parameters	A1	admin	0.0.0.0
14	2016-11-23 11:18:19	Operation	Local Configure Parameters	A1	admin	0.0.0.0
15	2016-11-23 11:18:19	Operation	Local Configure Parameters	A1	admin	0.0.0.0
16	2016-11-23 11:18:06	Operation	Local Configure Parameters	A1	admin	0.0.0.0
17	2016-11-23 11:18:06	Operation	Local Configure Parameters	A1	admin	0.0.0.0
18	2016-11-23 11:18:06	Operation	Local Configure Parameters	A1	admin	0.0.0.0
19	2016-11-23 11:18:05	Operation	Local Configure Parameters	A1	admin	0.0.0.0
20	2016-11-23 11:18:05	Operation	Local Configure Parameters	A1	admin	0.0.0.0
21	2016-11-23 11:17:37	Operation	Local Playback By Time	A1	admin	0.0.0.0
22	2016-11-23 11:17:17	Operation	Local Playback By Time	A1	admin	0.0.0.0
23	2016-11-23 11:16:28	Operation	Local Configure Parameters	A1	admin	0.0.0.0
24	2016-11-23 11:16:28	Operation	Local Configure Parameters	A1	admin	0.0.0.0
25	2016-11-23 11:16:08	Operation	Local Configure Parameters	A1	admin	0.0.0.0
26	2016-11-23 11:16:08	Operation	Local Configure Parameters	A1	admin	0.0.0.0
27	2016-11-23 11:14:52	Operation	Local Configure Parameters	A1	admin	0.0.0.0
28	2016-11-23 11:14:52	Operation	Local Configure Parameters	A1	admin	0.0.0.0
29	2016-11-23 11:14:28	Operation	Local Configure Parameters	A1	admin	0.0.0.0
30	2016-11-23 11:14:28	Operation	Local Configure Parameters	A1	admin	0.0.0.0
31	2016-11-23 11:11:07	Operation	Local Configure Parameters	A4	admin	0.0.0.0
32	2016-11-23 11:11:07	Operation	Local Configure Parameters	A4	admin	0.0.0.0

## Configure the recorder via the browser

Click **Configuration** on the menu toolbar to display the configuration window. There are two ways to configure the recorder: Local and Remote.

### Camera management

Camera configuration lets you define communication and network parameters such as protocol type, maximum file size, stream type and network transmission settings. You can also specify the directory locations for saving recorded and playback video, captured images, and downloaded files.

### Remote configuration

See Figure 35 on page 141 for an example of the Configuration screen. See Table 18 on page 141 for an overview of the different browser menu functions. Please refer to the specific sections on the OSD menu functions in the manual for more information on configuring these functions.



Go to **Browser Configuration** to set up the browser parameters. See “Access the web browser” on page 134 for further information.

**Note:** The configuration settings defined remotely are different from those that can be defined locally.

**Figure 35: Remote browser configuration window (Recording Schedule window shown)**

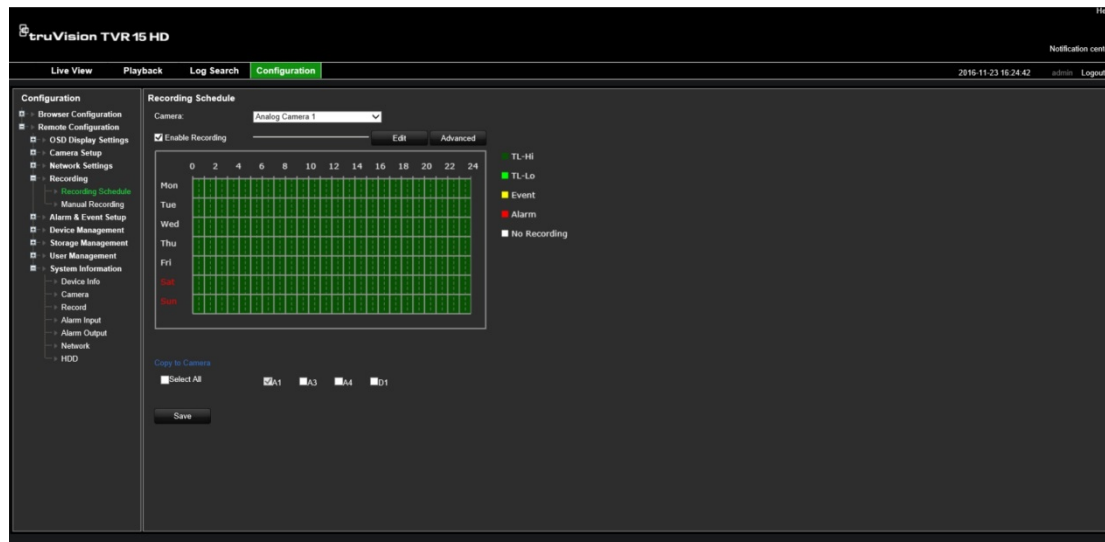

**Table 18: Description of remote configuration menus**

Menu	Function	Description
Camera Setup	Analog Camera Overview	Define the analog cameras. See “Configure the signal input channel” on page 63 for further information.
	IP Camera Status	Define the IP cameras. See “IP camera status” on page 64 for further information
	IPC Import/Export	Import and export the IP camera configuration information. See “Import/export IP camera files” on page 66 for further information.
	Camera Recording Settings	Define the general camera settings such as camera name, stream record mode, resolution, frame rate, audio recording, and pre and post event times. See “Camera recording settings” on page 66 for more information.
	Snapshots	Define the image quality of snapshots. See “Snapshots” on page 68 for further information.
	Camera OSD	Define which information is displayed on-screen. Only applied for analog cameras. See “Camera OSD” on page 69 for further information.
	Motion Detection	Define motion detection parameters. See “Motion detection” on page 71 for more information.
	Privacy Mask	Define the on-screen privacy mask areas. See “Privacy mask” on page 72 for more information.
	Camera Tamper	Define the video tampering detection settings. See “Camera tamper” on page 73 for more information.
	Text Overlay	Define the text to be added on-screen to display extra

Menu	Function	Description
		information, such as contact information. This text is embedded in the video and cannot be removed.  This can only be defined via the browser.
	PTZ Setup	Define the PTZ parameters of analog PTZ dome cameras. See “Configure PTZ settings” on page 75 for further information.
	BNC/V-stream	Define the V-stream parameters. See “V-stream encoding” on page 79 for more information.
	VCA	Define an area on screen to enable a VCA alarm from IP cameras. For analog cameras, the VCA setup is done from the recorder.  See “VCA setup” on page 74 for further information.
Network Settings	Network Settings	Define the general network settings. See “Network settings” on page 82 for more information.
	PPPoE	Define the PPPoE settings. See “PPPoE settings” on page 84 for more information.
	DDNS	Define the DDNS settings. See “DDNS settings” on page 85 for more information.
	NTP	Define the NTP server settings. See “NTP server settings” on page 86 for more information.
	Email	Define the settings to send an email. See “Email settings” on page 87 for more information.
	SNMP	Define the SNMP settings. See “SNMP settings” on page 88 for more information.
	Network Storage	Define the type and location of the network storage system. See “Add a HDD” on page 118 for further information.
	UPnP	Enable this function so that the recorder can automatically configure its own port forwarding. See “UPnP settings” on page 88 for more information.
	HTTPS	Define self-signed server certificates as well as request certified server certificates to ensure your network security.  See “HTTPS settings” on page 134 for further information.
	Network Statistics	Check the bandwidth being used by remote live view and playback. See “Network statistics” on page 91 for more information.
Recording	Recording Schedule	Define the recording schedules. See “Recording schedule” on page 92 for more information.
	Manual Recording	Define which cameras can manually record. See “Manual recording” on page 95 for more information.
Alarm & Event Setup	Alarm Input	Define the alarm input parameters for when an external alarm is triggered. See “Set up alarm inputs” on page 96 for more information.
	Alarm Output	Define the response when an external alarm is triggered. See “Manual trigger” on page 99 for more information.
	Manual Trigger	Define the manually trigger outputs of the recorder. See “Manual trigger” on page 99 for further information.

Menu	Function	Description
	Buzzer Settings	Define the warning buzzer time. See “Buzzer” on page 99 for more information.
	Notifications	Define the notification parameters when irregular events occur, such as a HDD is full. See “Alarm and event notification” on page 99 for more information.
	Video Loss	Define the video loss detection settings. See “Video loss” on page 102 for more information.
	Alarm Host Setup	Define the remote alarm host. See “Alarm host setup” on page 102 for more information.
	Intrusion Zone Setup	Define the alarm panel in the recorder. See “Intrusion integration alarm reporting” on page 103 for more information.
	Intrusion Panel Setup	Define the zones in an alarm panel. See “Intrusion integration alarm reporting” on page 103 for more information.
Device Management	Time & Date Setting	Define time and date. See “Time and date” on page 110 for more information.
	General Settings	Define the general settings of the recorder such as language, device name, enable the wizard, menu timeout, and enable front panel lock. See “General recorder settings” on page 112 for more information.
	Configuration Files	Import/export configuration settings, restore default factory settings, and restart the recorder. See “Configuration files” on page 113 for more information.
	Upgrade Firmware	Upgrade the recorder firmware. See “Upgrade system firmware” on page 114 for more information.
	Holiday	Define how recordings occur during holiday periods. See “Holiday schedules” on page 114 for more information.
	RS-232 Settings	Define the RS-232 parameters. See “RS-232 ” on page 115 for more information.
Storage Management	HDD Information	Define the HDD basic settings and initialize the HDD. See “HDD status information” on page 117 and “Initialize a HDD” on page 117 for more information.
	Storage Mode	Define the storage mode of the HDD. See “Storage mode” on page 118 and “Group HDDs” on page 119 for more information.
	S.M.A.R.T. Settings	List the S.M.A.R.T. information on the HDD. See “S.M.A.R.T. settings” on page 121 for more information.
User Management	Users	Define, modify, and delete users. See Chapter 16 “User management” on page 123 for more information.
System Information	Device Info	Review the status of the device. See Chapter 17 “information” on page 127 for more information.
	Camera	Review the status of the cameras. See Chapter 17 “System information” on page 127 for more information.
	Record	Review the status of the recordings. See Chapter 17 “System information” on page 127 for more information.

<b>Menu</b>	<b>Function</b>	<b>Description</b>
	Alarm Input	Review the status of the alarm inputs. See Chapter 17 "System information" on page 127 for more information.
	Alarm Output	Review the status of the alarm outputs. See Chapter 17 "System information" on page 127 for more information.
	Network	Review the status of the network. See Chapter 17 "System information" on page 127 for more information.
	HDD	Review the status of the HDD.

# Appendix A

## Specifications

	TVR 150c4HD	TVR 1508HD	TVR 1516HD
<b>Video &amp; audio input</b>			
Video compression	H.264		
Video input	4-ch, BNC interface (1.0 Vp-p, 75 Ω), supporting coaxitron connection	8-ch, BNC interface (1.0 Vp- p, 75 Ω), supporting coaxitron connection	16-ch, BNC interface (1.0 Vp-p, 75 Ω), supporting coaxitron connection
Supported HDTV input	1080p/25Hz, 1080p/30Hz, 720p/25Hz, 720p/30Hz, 720P/50Hz, 720p/60Hz, 3MP, 5MP		
BNC input	Supported		
IP video input	Up to 4-ch (Disabled all analog cameras)	Up to 8-ch (Disabled all analog cameras)	Up to 16-ch (Disabled all analog cameras)
Audio compression	G711u		
Audio input	4-ch, RCA (2.0 Vp-p, 1 kΩ)		
<b>Video &amp; audio output</b>			
BNC output	Support (Only for aux output)		
HDMI/VGA output	<b>VGA:</b> 1-ch, 1920 × 1080/60Hz, 1280 × 1024/60Hz, 1280 × 720/60Hz, 1024 × 768/60 Hz <b>HDMI:</b> 1-ch, 1920 × 1080/60Hz, 1280 × 1024/60Hz, 1280 × 720/60Hz, 1024 × 768/60 Hz		
Encoding resolution	5MP@12 fps / 3MP@15 fps / 1080p / 720p / WD1 / 4CIF / VGA/CIF		
Frame rate	<b>Main stream:</b> 25 fps (PAL) / 30 fps (NTSC) <b>Substream:</b> WD1/4 CIF@12 fps (non-real time); CIF / QVGA / QCIF (real time)		
Video bit rate	32 Kbps to 10 Mbps		
Analog output	1-ch, BNC (1.0 Vp-p, 75 Ω), Resolution: PAL: 704 × 576; NTSC: 704 × 480		
Audio output	1-ch, RCA (Linear, 1 KΩ)		
Audio bit rate	64 Kbps		
Stream type	Video, Video & Audio		

	TVR 150c4HD	TVR 1508HD	TVR 1516HD
Synchronous playback	4-ch	8-ch	16-ch
<b>Network management</b>			
Network protocols	TCP/IP, PPPoE, DHCP, DNS, DDNS, NTP, SADP, NFS, iSCSI, UPnP™, HTTPS, ONVIF		
<b>Hard disk</b>			
SATA	1 SATA interface	2 SATA interfaces	
Capacity	Up to 6TB capacity		
<b>External interface</b>			
Bi-directional audio input	1-ch, RCA (2.0 Vp-p, 1 K $\Omega$ ) (using the audio input)		
Network interface	1 RJ45 10M / 100M self-adaptive Ethernet interface	1 RJ45 10M / 100M / 1000M self-adaptive Ethernet interface	
Serial interface	1; RS-485 serial interface, half-duplex		
USB interface	Front panel: USB 2.0; Back panel: USB 3.0		
Alarm in/out	4/1	8/4	16/4
<b>Miscellaneous</b>			
Power supply	12 VDC		
Power consumption (without HDD)	$\leq 15$ W	$\leq 20$ W	
Operating temperature	-10 to +55 °C (14 to 131 °F)		
Relative humidity	10 to 90%		
Dimensions (W x H x D)	315 x 242 x 45 mm (12.4 x 9.5 x 1.8 in.)	380 x 320 x 48 mm (15.0 x 12.6 x 1.9 in.)	
Weight	$\leq 1.5$ kg (3.3 lb.)	$\leq 2$ kg (4.4 lb.)	

# Appendix B

## PTZ protocols

---

Interlogix-485

---

Interlogix-422

---

KALATEL

---

KTD-348

---

Pelco-D

---

Pelco-P

---

# Appendix C

## Port forwarding information

A router is a device that lets you share your internet connection between multiple computers. Most routers will not allow incoming traffic to the device unless you have configured them to forward the necessary ports to that device. By default our software and recorders require the following ports to be forwarded:

**Note:** Port forwarding may reduce the security of the computers on your network. Please contact your network administrator or a qualified network technician for further information.

Port: 80	HTTP protocol	Used to connect via IE browser.
Port: 8000	Client Software Port	Used to connect to video streams.
Port: 554	RTSP Port	Real time streaming protocol. Used to record video remotely.
Port: 1024	RTSP Port for 3G/4G	Use with mobile apps. Used for 3G/4G connection.

**Note:** It is recommended that the RTSP port 1024 should only be used when experiencing connection issues over a 3G/4G connection.

## Seeking further assistance

Third-party assistance on configuring popular routers can be found at:

<http://www.portforward.com/>

<http://canyouseeme.org/>

<http://yougetsignal.com>

Note: These links are not affiliated with nor supported by Interlogix technical support.

Many router manufacturers also offer guides on their websites as well as including documentation with the product.

On most routers the brand and model number is located on or near the serial number sticker on the bottom of the device.



If you cannot find any information for your particular router, please contact your router manufacturer or internet service provider for further assistance.

# Appendix D

## Supported PTZ commands

**Table 19: Supported PTZ commands by camera protocols (Part 1)**

Protocol	PTZ command												
	Tilt up	Tilt down	Pan left	Pan right	Left up	Left down	Right up	Right down	Auto pan	Zoom +	Zoom -	Focus +	Focus -
Interlogix-485	Y	Y	Y	Y	N	N	N	N	N	Y	Y	Y	Y
Interlogix-422	Y	Y	Y	Y	N	N	N	N	N	Y	Y	Y	Y
KALATEL	Y	Y	Y	Y	N	N	N	N	N	Y	Y	Y	Y
DSCP	Y	Y	Y	Y	N	N	N	N	N	Y	Y	Y	Y
HIKVISION	Y	Y	Y	Y	Y	Y	Y	Y	Y	Y	Y	Y	Y
Honeywell	Y	Y	Y	Y	N	N	N	N	N	Y	Y	Y	Y
INFINOVA	Y	Y	Y	Y	N	N	N	N	N	Y	Y	Y	Y
KTD-348	Y	Y	Y	Y	N	N	N	N	N	Y	Y	Y	Y
LG MULTIX	Y	Y	Y	Y	N	N	N	N	N	Y	Y	Y	Y
LILIN	Y	Y	Y	Y	N	N	N	N	N	Y	Y	Y	Y
PANASONIC_CS850	Y	Y	Y	Y	N	N	N	N	N	Y	Y	Y	Y
PELCO-D	Y	Y	Y	Y	Y*	Y*	Y*	Y*	Y	Y	Y	Y	Y
PELCO-P	Y	Y	Y	Y	Y*	Y*	Y*	Y*	Y	Y	Y	Y	Y
PHILIPS	Y	Y	Y	Y	N	N	N	N	N	Y	Y	Y	Y
PHILIPS-3	Y	Y	Y	Y	N	N	N	N	N	Y	Y	Y	Y
SAE	Y	Y	Y	Y	N	N	N	N	N	Y	Y	Y	Y
Samsung	Y	Y	Y	Y	N	N	N	N	N	Y	Y	Y	Y
Siemens	Y	Y	Y	Y	N	N	N	N	N	Y	Y	Y	Y
SONY-EVI-D30/31	Y	Y	Y	Y	N	N	N	N	N	N	N	N	N
SONY-EVI-D70	Y	Y	Y	Y	N	N	N	N	N	N	N	N	N
SONY-EVI-D100/P	Y	Y	Y	Y	N	N	N	N	N	N	N	N	N

Protocol	PTZ command												
	Tilt up	Tilt down	Pan left	Pan right	Left up	Left down	Right up	Right down	Auto pan	Zoom +	Zoom -	Focus +	Focus -
TECHWIN	Y	Y	Y	Y	N	N	N	N	N	N	N	N	N
VICON	Y	Y	Y	Y	N	N	N	N	N	Y	Y	Y	Y
YOULI	Y	Y	Y	Y	N	N	N	N	N	Y	Y	Y	Y

\*: Hikvision only.

**Table 20: Supported PTZ commands by camera protocols (Part 2)**

Protocol	PTZ command										
	Iris+	Iris-	Light	Wiper	Zoom area	Center	Menu	Preset	Tour	Shadow tour	
Interlogix-485	Y	Y	N	N	N	N	N	Y	N	Y	
Interlogix-422	Y	Y	N	N	N	N	N	Y	N	Y	
KALATEL	Y	Y	N	N	N	N	N	Y	N	Y	
DSCP	Y	Y	N	N	N	N	N	Y	N	Y	
HIKVISION	Y	Y	N	N	Y	Y	Y	Y	Y	Y	
Honeywell	Y	Y	N	N	N	N	N	N	N	N	
INFINOVA	Y	Y	N	N	N	N	N	Y	N	Y	
KTD-348	Y	Y	N	N	N	N	N	Y	N	Y	
LG MULTIX	Y	Y	N	N	N	N	N	Y	Y	Y	
LILIN	Y	Y	N	N	N	N	N	N	N	N	
PANASONIC_CS850	Y	Y	N	N	N	N	N	Y	N	Y	
PELCO-D	Y	Y	Y**	Y#	N	N	N	Y	Y	Y	
PELCO-P	Y	Y	N	N	N	N	N	Y	Y	Y	
PHILIPS	Y	Y	N	N	N	N	N	N	N	N	
PHILIPS-3	Y	Y	N	N	N	N	N	N	N	N	
SAE	Y	Y	N	N	N	N	N	Y	Y	Y	
Samsung	Y	Y	N	N	N	N	N	Y	N	Y	
Siemens	Y	Y	N	N	N	N	N	Y	N	Y	
SONY-EVI-D30/31	N	N	N	N	N	N	N	N	N	N	
SONY-EVI-D70	N	N	N	N	N	N	N	N	N	N	
SONY-EVI-D100/P	N	N	N	N	N	N	N	N	N	N	
TECHWIN	Y	Y	N	N	N	N	N	Y	N	N	
VICON	Y	Y	N	N	N	N	N	N	N	N	
YOULI	Y	Y	N	N	N	N	N	Y	N	N	

\*\* : Aux. 2

# : Aux. 1

# Appendix E

## Default menu settings

<b>Display Settings</b>	
Display	
General	
	BNC Output Standard:
	Picture Setting: Standard
	BNC Output Brightness: (Null)
	VGA/HDMI Resolution: (Null)
	Display Status Icons: Enabled
	Time Bar Transparent: (Null)
	Enable Timebar: Enabled
	Video Output Interface: VGA/HDMI
	Default View: 1*1, 2*2, 1+5, 1+7, 3*3 (for 8-ch models), and 4*4 (16-ch models)
	Sequence Dwell Time: No switch
	Enable Audio Output: Disabled
	Volume: (Null)
	Event Monitor: VGA/HDMI
	Event Full-Screen Monitoring Dwell Time: 10
	Alarm Full-Screen Monitoring Dwell Time: 10
Layout	
	Video Output Interface: VGA/HDMI
<b>Camera Setup</b>	
Analog Camera Overview	
Signal Input Status	
	Camera Number: (Null)
	TVI/CDBS: (Null)
	IP: (Null)

IP Camera Status	
IP Camera	
	Camera No., Status, Edit, Advanced Set, Live View, Camera Name, IP Camera Address, Manage Port, Protocol, Device Model, Serial Number, and Firmware
IP Camera Import/Export	
	Device Name, Name, Fee Space
Camera Recording Settings	
Record	
	Camera Name: [A1] Camera 01
	Stream Record Mode: Main Stream (TL-Hi)
	Stream Type: Video
	Resolution: 960*576 (WD1)
	Bitrate Type: Variable
	Video Quality: Medium
	Frame Rate:
	Max. Bitrate Mode: General
	Max Bitrate (Kbps): 1792
	Pre Event: 5 s
	Post Event: 5 s
	Auto Delete (day): 0
	Record Audio: Disabled
Snapshots	
Snapshot	
	Camera: [A1] Camera 01
	Resolution: Maximum
	Snapshot quality: Medium
Camera OSD	
Camera OSD Settings	
	Camera: [A1] Camera 01
	Camera Name: Camera 01
	Display Name: Enabled
	Display Date: Enabled
	Display Day: Enabled
	Date Format: MM-DD-YYYY
	Time Format: 24-hour
	Display Mode: Non-transparent & Not Flashing
	OSD font: 32*32

Image	
	Image Settings
	Camera: [A1] Camera 01
	Image Setting: Standard
	Brightness: 128
	Contrast: 128
	Saturation: 128
	Hue: 128
	Sharpness: 1
	Digital Noise: 2
Motion Detection	
	Motion Detection Settings
	Camera: [A1] Camera 01
	Enable Motion Detection: Disabled
	Actions: Trigger Channel [A1]; Arming Schedule - All day for whole week; Actions: (Null)
	Sensitivity: 2
	Target size: 1
Privacy Mask	
	Privacy Mask Settings
	Camera: [A1] Camera 01
	Enable Privacy Mask: Disabled
	Zone: (Null)
Camera Tamper	
	Camera Tamper Settings
	Camera: [A1] Camera 01
	Enable Camera Tamper: Disabled
	Actions: Arming Schedule - All day for whole week; Actions: (Null)
	Sensitivity: 1
VCA	
	VCA
	Camera: [A1] Camera 01
	Enable VCA Alarm: Disabled
	VCA Type: Cross Line Detected
	Actions: Arming Schedule - All day for whole week; Actions: (Null)
	Rule: 1

PTZ Setup	
Settings	
	Camera: [A1] Camera 01
	Baud Rate: 9600
	Date Bit: 8
	Stop Bit: 1
	Parity: None
	Flow Ctrl: None
	PTZ Protocol: TruVision-Coax
	Address: 0 to 15 for camera 1 to 16
PTZ Preset/Tours	
Preset/Tours	
	Camera: [A1] Camera 01
V-stream Encoding	
V-stream Encoding	
	Enable V-stream Encoding: Yes
	Frame Rate: 12fps
	Max. Bitrate (Kbps): 1024
People Counting	
People Counting Statistics	
	Camera: [D1] IPCamera 01
	Report Type: Daily Report
	Statistics Time: [Date]
<b>Networking Settings</b>	
Network Settings	
Network Settings	
	NIC Type: 10M/100M/1000M Self-adaptive
	Enable DHCP: Disabled
	IPv4 address: 192.168.1.82
	IPv4 Subnet Mask: 255.255.255.0
	IPv4 Default Gateway: 192.168.1.1
	IPv6 Address1: (Null)
	IPv6 Address2: (Null)
	IPv6 Address Gateway: (Null)
	Mac Address: (It depends)
	MTU: 1500
	Preferred DNS Server: (Null)
	Alternate DNS Server: (Null)



		Server Port: 8000
		HTTP Port: 80
		Multicast IP: (Null)
		RTSP Server Port: 554
		Total Bandwidth Limit (Kbps): (Null)
PPPoE		
	PPPoE	
		Enable PPPoE: Disabled
		User Name: (Null)
		Password: (Null)
		Confirm: (Null)
DDNS		
	DDNS	
		DDNS: Disabled
		DDNS Type: ezDDNS
		Server Address: www.tvr-ddns.net
		Host Name: (Null)
NTP		
	NTP	
		Enable NTP: Disabled
		Interval (min): 60
		NTP Server: time.nist.gov
		NTP Port: 123
Email		
	Email	
		Enable Server Authentication: Disabled
		User Name: (Null)
		Password: (Null)
		SMTP Server: (Null)
		SMTP Port: 25
		Enable SSL: Disabled
		Sender: (Null)
		Sender's Address: (Null)
		Select Receiver: Receiver 1
		Receiver Name: (Null)
		Receiver's Address: (Null)
		Include Snapshot: Disabled
		Interval: 2 s

SNMP	
SNMP	Enable SNMP: Disable SNMP Version: SNMP Port: 161 Read Community: public Write Community: private Trap Address: (Null) Trap Port: 162
UPnP	
UPnP	Enable UPnP: Disabled Mapped Type: Auto Port Type: HTTP Port; RTSP Port ; Server Port ; HTTPS Port
Net Detect	
Traffic	Name: LAN1 Select NIC: LAN1 Destination Address: (Null) Device Name: (Null)
Network Statistics	
Network Stat.	Type: Bandwidth IP Camera: 0bps Remote Live View: 0bps Remote Playback: 0bps Net Total Idle: (Null) Total Bandwidth Limit: (Null)
<b>Recording</b>	
Recording Schedule	
Recording	Camera: [A1] Camera 01 Enable Recording: Enabled Schedule: All day for whole week TL-Hi

General	
General	Instant Playback Duration: 5 minutes
Manual Recording	
Manual Recording	Analog: Disabled
<b>Alarm &amp; Event Setup</b>	
Alarm Input	
Alarm Input	Alarm Input No.: A<-1
	Alarm Input Name: (Null)
	Type: NO
	Enable Alarm Input: Disabled
	Actions: Trigger channel - Disabled; Alarm Schedule - All day for whole week; Actions (Disabled); PTZ link: (Disabled)
Alarm Output	
Alarm Output	Alarm Output No.: A->1
	Alarm Output Name: (Null)
	Time Out: 5 s
	Actions: All day for whole week
Manual Trigger	
Manual Alarm	Trigger: No
Buzzer Settings	
	System Buzzer Time: Constant
	Camera Buzzer Time: Constant
Notifications	
Notification	Display Event Icon: Enabled
	Event Hint Settings: All Enabled
	Event Priority: VCA < Motion
	Notification Type: HDD Full
	Enable Alarm Audio: Disabled
	Notify Alarm Host: Disabled
	Send Email: Disabled
	Trigger Alarm Output: Disabled

Video Loss	
	Video Loss Settings
	Camera: [A1] Camera 01
	Enable Video Loss Alarm: Disabled
	Actions: Arming Schedule - All day for whole week; Actions (All disabled)
Alarm Host Setup	
	Alarm Host Setup
	Alarm Host 1 IP: (Null)
	Alarm Host 1 Port: 5001
	Alarm Host 2 IP: (Null)
	Alarm Host 2 Port: 5001
	Alarm Host 3 IP: (Null)
	Alarm Host 3 Port: 5001
Intrusion Panel Setup	
	Intrusion Panel Setup
	Enable Intrusion Panel Connection: Disabled
	Select Intrusion Panel: 1
	Name Intrusion Panel: Panel 1
	Number of Zones: 32
	IP Address Intrusion Panel: (Null)
	Server Port: (Null)
	Enable Panel Heartbeat Alarm: Disabled
	Heart Beat Interval(s): 30
	Actions: Trigger Channel; Arming Schedule; Actions; PTZ Linking
	Enable Panel Arming Alarm: Disabled
	Actions: Trigger Channel; Arming Schedule; Actions; PTZ Linking
	Enable Panel Disarming Alarm: Disabled
	Actions: Trigger Channel; Arming Schedule; Actions; PTZ Linking
Intrusion Zone Setup	
	Intrusion Zone Setup
	Select Intrusion Panel: 1
	ID: 1
	Zone Number: 1
	Actions: Trigger Channel, Arming Schedule; Actions; PTZ Linking

<b>Device Management</b>	
Time & Date Settings	
DST Settings	
	Time Zone: (GMT-08:00) Pacific Time (U.S. & Canada)
	Date Format: MM-DD-YYYY
	Time Format: 24-hour
	Display Day: Disabled
	System Date: Current System Date
	System Time: Current System Time
	Auto DST Adjustment: Disabled
	Enable DST: Disabled
	From: Apr 1st Sun 2:00
	To: Oct last Sun 2:00
	DST Bias: 60 minutes
General Settings	
General	
	Language: English
	Device Name: TVR 15HD
	Remoter Control ID: 255
	Keypad Zone ID: 1
	Menu Timeout: 5 Minutes
	Output Mode: Auto
	Mouse Pointer Speed: (Null)
	Enable Wizard: Enabled
	Password Required: Disabled
	Start Wizard Now: Disabled
	Enable Front Panel Lock: Disabled
Configuration Files	
Import/Export Config File	
	Device Name: (Null)
Upgrade Firmware	
Local Upgrade	
	Source: USB
	Device Name: (Null)
Holiday	
Holiday Settings	
	Status: All Disabled; Start Date: 1st. Jan; End Date: 1st Jan

RS-232 Settings	
RS-232 Settings	
	Baud Rate: 115200
	Data Bit: 8
	Stop Bit: 1
	Parity: None
	Flow Ctrl: None
	Interface: Technical Support
<b>Storage Management</b>	
HDD Information	
	Label: Disabled
	Total Capacity:
	Free Space:
	Overwrite: Enabled
Storage Mode	
Storage Mode	
	Mode: Quota
	Camera: [A1] Camera 01
	Used Record Capacity:
	Used Snapshot Capacity:
	HDD Capacity (GB):
	Max Record Capacity (GB):
	Max Snapshot Capacity (GB):
	Enable HDD Sleeping: Enabled
S.M.A.R.T. Settings	
S.M.A.R.T. Settings	
	Use when the disk has failed to self-evaluate: Disabled
	HDD No.: 1
	Self-test Status: Not Tested
	Self-test Type: Short Test
	S.M.A.R.T.:
	Temperature (°C):
	Power Up (days):
	Self-evaluation:
	All-evaluation: Functional
	S.M.A.R.T. Information : ID ; Attribute Name ; Status ; Flags ; Threshold ; Value ; Worst ; Raw Value

Bad Sector Detection	
	HDD No.: (Null)
	HDD Capacity: (Null)
	Block Capacity: (Null)
	Status: (Null)
	Error Count: (Null)
User Management	
Users	
	User Management
	admin: (user defined)
<b>System Information</b>	
Device Info	
	Device Info
	Device Name: TVR 15HD
	Model: (Model number)
	Serial No.: (Model's serial number)
	Firmware Version:
	Encoding Version:
Camera	
	Camera
	Camera No.; Camera Name; Status; Motion Detection; Camera Tamper, Video Loss; Preview; Preview Link
Record	
	Record
	Camera No.; Recording Status; Stream Type; Frame Rate; Bitrate (Kbps); Resolution; Record Type; Active Schedule
Alarm Inputs	
	Alarm Inputs
	No.; Alarm Name; Alarm Type; Alarm Status; Triggered Camera
Alarm Outputs	
	Alarm Outputs
	No.; Alarm Name; Alarm Status
Network	
	Network
	NIC:
	IPv4 Address:
	IPv4 Subnet Mask

		IPv4 Default Gateway
		IPv6 Address 1
		IPv6 Address 2
		IPv6 Default Gateway
		MAC Address
		Preferred DNS Server
		Alternate DNS Server
		Enable DHCP: Disabled
		Enable PPPOE: Disabled
HDD		
	HDD	
		Label; Status; Capacity; Free Space; Property; Type; Group
Log search		
	Log search	
		Start Time:
		End Time:
		Event: All
		Type: All



# Index

## A

- Alarm inputs
  - set up, 96
- Alarm notifications
  - external alarms, 96
  - response actions, 97
  - types, 99
  - video loss, 102
  - video tamper, 73
  - warning buzzer, 99
- Alarm outputs
  - manual acknowledgment, 99
  - set up, 98

- Analog cameras
  - setup, 63

- Archive
  - bookmarks, 56
  - export files to a backup device, 54
  - locked files, 56
  - quick archive, 54
  - search results, 54
  - video clips, 56

## B

- Back panel description, 9
- Bad sector detection, 121
- Bookmarks
  - archive, 56
  - create, 51
  - playback, 51
  - saving, 51
  - types, 51
- Brightness, contrast and saturation
  - modifying, 70

## C

- Cameras
  - configure PTZ dome cameras, 75
  - image settings, 70
  - layout, 60
  - limitations, 62
  - privacy mask, 72
  - supported, 62
- Configuration settings

- export, 113
- import, 113

## D

- Daily schedules
  - recording, 94
- Date format, 110
- DDNS settings, 85
- Default settings
  - restore, 113
- Digital zoom
  - description, 30
  - playback, 50
  - web browser, 139
- DST, 110
- Dwell time, 59

## E

- Email
  - encryption, 87
  - notification set up, 87
- Event logs
  - search remotely, 139
- Event notifications
  - types, 99

## F

- Factory default settings
  - restore, 113
- Firmware
  - update, 114
- Frame-by-frame playback, 48
- Front panel
  - button functions by task, 17
- Front panel description, 16
- Front panel lock, 112, 113

## H

- HDD
  - add, 118
  - check status, 117
  - group, 119
  - grouping, 119
  - initialize, 117

- overwrite, 118
- properties, 120
- storage mode, 118

Holiday schedules

- record, 114

## I

Instant playback, 38

Intrusion integration alarm reporting

- setup, 103

Intrusion panel setup, 103

IP cameras

- setup, 64

IR remote control

- change ID, 112
- description, 19

## L

Language

- change GUI language, 112

Live view

- digital zoom, 30
- presets and preset tours, 31
- shadow tours, 31
- toolbar, 28
- web browser, 135

Local audio output, 59

Lock/unlock recorded files, 51

Locked files

- archive, 56

## M

Main menu

- description, 21

Manual recording, 95

Menu timeout

- change, 112

Monitor time bar

- display, 59

Monitors

- change output mode, 112
- connect, 10
- resolution, 59
- select main/event, 59
- video outputs, 26

Motion detection

- playback, 43
- setup, 71
- smart playback, 45

Mouse pointer speed

- change, 112

Mouse pop-up menu, 26

Multiview layout, 59

## N

Network packet data

- export, 90

Network settings

- general set up, 82

Network status, 89

Network traffic

- check, 89

NTP server, 87

## O

OSD settings, 69

## P

Password

- activate admin, 6
- change admin password, 126
- change user password, 126
- enable/disable login password, 112

Password required, 112

Playback

- 24-hour playback, 42
- alarm inputs, 43
- arcived files, 49
- bookmarked recordings, 35
- bookmarks, 43, 51
- change playback speed, 48
- event recordings, 35
- events, 43
- import external files, 43
- instant playback, 38
- motion and VCA events, 45
- motion detection, 43
- search by time and date, 34
- search by video type, 34
- search results, 34
- skip time, 48
- smart events, 45
- snapshots, 36, 43
- split-screen, 46
- sub-periods, 46
- use the web browser, 138

Playback control panel

- description, 40

Port forwarding, 91

Power up and down recorder, 12

PPPoE settings, 84

Preset tours

- set up, 78

Presets

- cal up, 78
- quick access, 31
- select, set up and delete, 77
- set up, 77

Privacy mask, 72

PTZ control panel

- description, 31

PTZ dome cameras

- configure, 75
- control remotely, 137

PTZ protocols  
assign, 75

## Q

Quick archive, 54

## R

Recorder name  
change, 112

Recording  
recording schedules, 92  
setup, 66

Recording schedules  
daily, 94, 114  
define, 92

Remote alarm host settings, 103

Remote control  
connect to the recorder, 21

RS-232 port  
set up, 115

## S

S.M.A.R.T. information, 121

Search  
bookmarked recordings, 35  
bookmarks, 51  
event recordings, 35  
logs, 37  
snapshots, 36  
system logs, 130

Sequence cameras, 28

Shadow tours  
quick access, 31  
set up, 79

Skip time  
playback, 48

Smart events  
playback, 45

Snapshots  
capture remotely, 138  
setup, 68  
view, 36, 49

SNMP protocol settings, 88

Soft keyboard, 23

Startup wizard  
enable/disable, 112

Startup wizard, 13

Status icons  
description, 25  
display, 59

System date  
display, 110

System information  
view, 127

System logs  
playback, 130  
search, 130

System time  
display, 110

## T

Time bar  
display, 59

Time format, 110

TruVision Navigator  
export recordings, 57

TruVision Player, 53

TVRMobile  
push notifications, 107

## U

User privileges  
camera configuration, 125  
local configuration, 124  
remote configuration, 124

Users  
add a new user, 123  
customize user privileges, 124  
delete a user, 125  
modify user information, 126

## V

VCA  
setup alarm actions, 74  
types, 74

VCA events  
playback, 43, 45

Video clips  
archive, 56  
create, 50

Video format  
PAL/NTSC, 12

Video loss  
setting up detection, 102

Video outputs, 26

Video search menu, 33

Video tamper  
set up to detect, 73

V-stream encoding, 79

## W

Warning buzzer, 99

Web browser  
access, 134  
camera management, 140  
control PTZ dome camera, 137  
digital zoom, 139  
live view, 135  
network settings, 134  
remote configuration of recorder, 140  
search and play back recorded video, 138  
search event logs, 139  
video snapshot, 138

