



IP Cameras

MEGAPIX® IVA+™ models	5MP models	2.1MP models
DWC-MPV85WiATW DWC-MPV82WiATW	DWC-MV85WiAT DWC-MV85WiATW	DWC-MV82WiAT DWC-MV82WiATW DWC-MV82DiVT



Default Login Information: admin | admin

When logging into the camera for the first time, you will be prompted to set up a new password. You can set the new password using the DW® IP Finder™ software or directly from the camera's browser menu.

WHAT'S IN THE BOX

Mounting Bolts and Nuts		1 set	Mounting Template for Metal Plate Installation		1
Metal Mounting Plate		1	Star Wrench		1
Quick Setup and Installation Guides		1 set	Moisture Absorber and Absorber Guide (Recommended)		1 set
Screws and Plastic Anchors-3pcs		1 set	Waterproof Cap and Gasket		1 set
Mounting Template a Bolt and Nut Installation		1	Test Video Cable (DWC-MV85WiAT, DWC-MV82WiAT)		1

NOTE: Download all your support materials and tools in one place

- Go to: <http://www.digital-watchdog.com/resources>
- Search your product by entering the part number in the 'Search by Product' search bar. Results for applicable part numbers will populate automatically based on the part number you enter.
- Click 'Search'. All supported materials, including manuals and quick start guide (QSGs) will appear in the results.



Attention: This document is intended to serve as a quick reference for the initial setup. It is recommended that the user read the entire instruction manual for complete and proper installation and usage.

Tel: +1 (866) 446-3595 / (813) 888-9555

digital-watchdog.com

Technical Support Hours:
9:00 AM - 8:00 PM EST, Monday through Friday

STEP 1 - PREPARING TO MOUNT THE CAMERA

- The mounting surface must withstand five times the camera weight.
- Do not let the cables get caught in improper places or the electric line cover can be damaged. This may cause a short or fire.
- CAUTION:** These servicing instructions are for use by qualified service personnel only. To reduce the risk of electric shock do not perform any servicing other than that contained in the operating instructions unless you are qualified to do so.
- CAUTION:** There is a risk of explosion if the battery is replaced incorrectly and it should be replaced only with the same battery. **ATTENTION:** Il y a risque d'explosion si la batterie est remplacée par une batterie de type incorrect. Mettre au rebut les batteries usages conformément aux instructions.
- Used batteries must be disposed of according to local regulations or the battery manufacturer's instructions. Disposing of batteries in a fire or in a hot oven, or mechanically crushing and cutting them may cause an explosion.
- Leaving the battery in very high temperature or low air pressure environments may result in an explosion or leak of flammable liquids or gases.
- This product is intended to be supplied by a UL Listed Power Supply Unit marked "Class 2" or "LPS" or "PS2" and rated 12 Vdc, 0.62A (DWC-MPV85WiAT and DWC-MV85WiAT), 0.54A (DWC-MPV82WiAT and DWC-MV82WiAT) and 0.36A (DWC-MV82DiVT) min.
- The wired LAN hub providing power over the Ethernet (PoE) in accordance with IEEE 802-3af shall be a UL Listed device with the output evaluated as a Limited Power Source as defined in UL60950-1 or PS2 as defined in UL62368-1.
- Unit is intended for installation in a Network Environment 0 as defined in IEC TR 62102. As such, associated Ethernet wiring shall be limited to inside the building.

- For the installation process, remove the dome cover from the camera module by loosening the three (3) screws on the dome. Use the wrench provided with the camera.

11. Install the moisture packet in the base of the camera's lens.

- Remove the moisture absorber from the packaging.
- Cut the card and folder along the dotted line.
- Place the moisture absorber behind the camera's lens module.

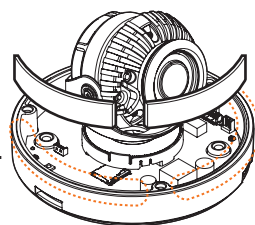

NOTE: The camera will generate enough heat to dry moisture during operation. In most cases it will not need the moisture absorber for more than the first day. In cases where the camera can experience a moisture issue, users must keep the moisture absorber in the camera. The moisture absorber has an approximately 6-month life cycle, varying depending on the environment.

WARNING: It is highly recommended that you install the moisture absorber when mounting the camera. The moisture absorber prevents moisture from being captured inside the camera's housing, which may cause image performance issues and damage the camera.

- Remove the protective film between the dome and the camera module.
- Remove the screw hole caps as shown in the image below. If you are mounting the camera using the mounting plate, do not remove these screws.
- Using the mounting template sheet or the camera itself, mark and drill the necessary holes in the wall or ceiling.

STEP 2 - POWERING THE CAMERA

Pass the wires through and make all the necessary connections.

- NETWORK CONNECTIONS** - If you are using a PoE Switch, connect the camera using an Ethernet cable for both data and power.
- NETWORK CONNECTIONS** - If you are using a non-PoE switch, connect the camera to the switch using an Ethernet cable for data transmission and use a power adapter to power the camera.

Models	Power requirements	Power consumption
DWC-MPV85WiATW DWC-MV85WiATW DWC-MV85WiAT	DC 12V, PoE IEEE 802.3af Class 3. (Adapter not included)	DC12V: max 7.4W PoE: max 8.7W
DWC-MPV82WiATW DWC-MV82WiATW DWC-MV82WiAT		DC12V: max 6.5W PoE: max 8.5W
DWC-MV82DiVT		DC12V: max 4.3W PoE: max 6.2W

STEP 3 - INSTALLING THE CAMERA

- Attach the camera to the mounting surface.
- For soft installation surfaces, use the included metal mount plate. Fix the mount plate on the mounting surface using the included screws. Then, press the bottom case onto the mount plate. The three bezels on the case will align and snap lock onto the plate.
- To use the camera's waterproof wiring:
 - Install the LAN cable into **a**.
 - b** will be assembled to **a** with a 1/4 turn.
 - Thread **c** tightly to **b**.
- Once the installation is complete, remove the protective film from the camera's dome cover.
- Assemble the dome cover over the camera body and detach the protecting film from the dome bubble.

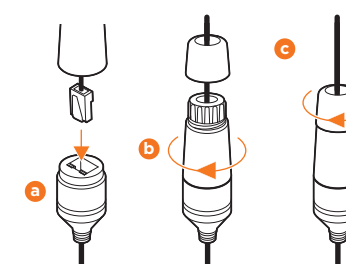

NOTE: To ensure moisture seal, make sure the o-ring is in place between **a** and **b**. In extreme environments use of an outdoor rated sealer is recommended.

NOTE: When using the waterproof cap, crimp the RJ45 connector after passing the cable through the waterproof cap.

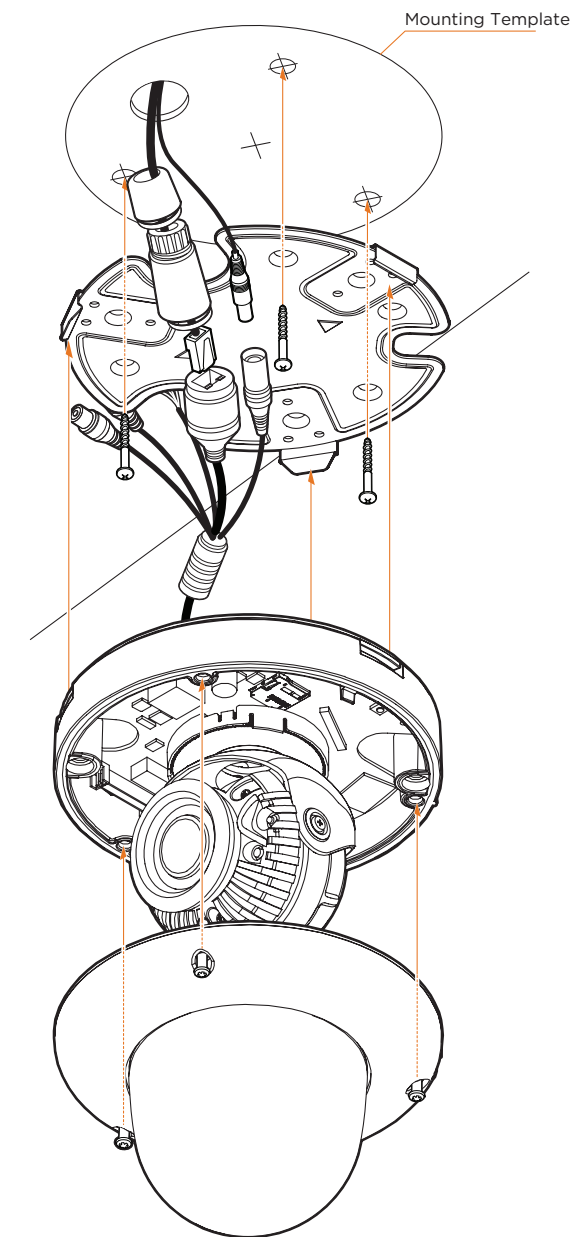

Resetting the camera: To reset the camera, use the tip of a paper clip or a pencil and press the reset button. Pressing the button for five (5) seconds will initiate a camera-wide reset of all the settings, including network settings.

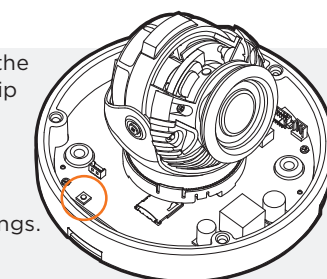

STEP 3 - INSTALLING THE CAMERA (CONT.)

Installation using Mount Bolt and Screws:

- Using the mounting template, mark and drill the holes on the mounting surface.
- Secure the two long mounting screws to the camera's base.
- Pass the wires through the mount bracket and make all necessary connections.
- Mount the camera to the mounting surface by using the 2 mounting nuts. Rotate the locking discs over the screws until the camera is held tightly from the mounting surface.

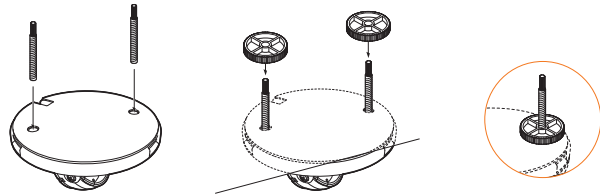

WARNING DO NOT TOUCH THE SURFACE OF THE BUBBLE. CleanView™ Hydrophobic Dome Coating has been applied to the camera's dome.

STEP 4 - CABLING

The following models include I/O and audio inputs and outputs: DWC-MPV85WiAT, DWC-MV85WiAT, DWC-MPV82WiAT and DWC-MV82WiAT

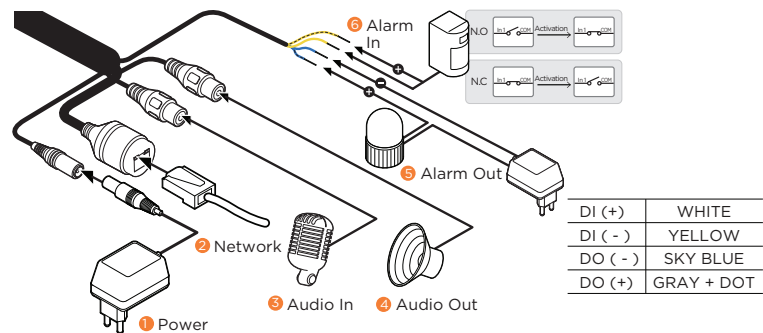

STEP 5 - MANAGING THE SD CARD

The following models include a local SD card slot: DWC-MV85WiAT, DWC-MV82WiAT

- To install the camera's SD Card, locate the SD card slot in the back of the camera module.
- Insert a class 10 SD card into the SD card slot by pressing the SD card slot.
- To remove the SD Card, press the card inward to release from the card slot.

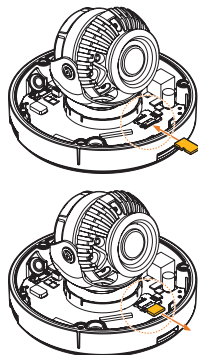

STEP 6 - DW® IP FINDER™

Use the DW IP Finder software to scan the network and detect all MEGApix® cameras, set the camera's network settings or access the camera's web client.

Thumbnail view

Select network to scan: Local Area Connection [192.168.0.18]

Filter results: All

Scan network: Scan Devices

Show/hide thumbnail view: Refresh Thumbnail

Refresh thumbnail view: Bulk IP Assignment, Bulk Password Assignment, FW Upgrade

Firmware upgrade

Name	IP Address	Model	MAC Address	Netmask	Gateway	Port	DHCP	Version	Ping Test	IP Conf.	Uptime
DWC-MP-Z30X	192.168.50.34	DWC-MP-Z30X	00:07:09:19:10:1A	255.255.255.0	192.168.150.1	80	Disabled	1.9.94-X2_release	Ping	Click	
DWC-MV-4WA	192.168.50.40	DWC-MV-4WA	00:0D:F1:21:53:8F	255.255.255.0	192.168.150.1	80	Disabled	A2.01.02_20180619	Ping	Click	28day 14hrs
DWC-PZ-1M69T	192.168.50.41	DWC-PZ-1M69T	00:0D:F1:21:29:21	255.255.255.0	192.168.150.1	80	Disabled	A5.01.03_20180403	Ping	Click	39day 15hrs 54mins
DWC-PV-16W4	192.168.50.42	DWC-PV-16W4	00:0D:F1:21:5C:AD	255.255.255.0	192.168.150.1	80	Disabled	A2.01.01_20180309	Ping	Click	56day 16hrs
DWC-PF-11TR	192.168.50.61	DWC-PF-11TR	00:0A:61:1A:00:14	255.255.255.0	192.168.150.1	80	Disabled		Ping	Click	--
DWC-PV-19M2TR	192.168.150.62	DWC-PV-19M2TR	00:0A:61:1A:26:E7	255.255.255.0	192.168.150.1	80	Disabled		Ping	Click	--
DWC-MF-4W4	192.168.150.63	DWC-MF-4W4	00:0D:F1:20:FB:60	255.255.255.0	192.168.150.1	80	Disabled	A2.01.02_20180619	Ping	Click	28day 14hrs

Labels on the right side of the screenshot:

- DHCP status
- Firmware version
- Camera's uptime
- Open IP configuration settings
- Ping camera
- Port information
- Gateway address
- Netmask address
- Camera's MAC address
- Part number
- Camera's IP address
- Camera's name

Network Setup

- To install the DW IP Finder, go to <http://www.digital-watchdog.com>
- Enter "DW IP Finder" on the search box at the top of the page.
- Go to the "Software" tab on the DW IP Finder page to download the installation file.
- Follow the installation to install the DW IP Finder. Open the DW IP Finder and click 'Scan Devices'. It will scan the selected network for all supported devices and list the results in the table. During the scan, the DW® logo will turn gray.

Select DHCP to allow the camera to receive its IP address automatically from the DHCP server.

Select "Static" to manually enter the camera's IP address, (Sub) Netmask, Gateway and DNS information.

* The camera's IP must be set to Static if connecting to Spectrum® IPVMS

Contact your network administrator for more information.

Default TCP/IP information: DHCP

- When connecting to the camera for the first time, a password must be set. To set up a password for your new camera:
 - Check the box next to your new camera from the IP Finder's search results. You can select multiple cameras.
 - Click "Bulk Password Assign" on the left.

- In the pop-up window, enter admin/admin in the current username and password fields. Enter a new username and password to the right.
- Press "change" to apply all changes.

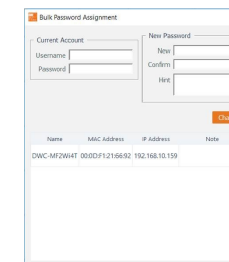

- Select a camera from the list by double-clicking on the camera's image or clicking on the 'Click' button under the IP Conf. column. The pop-up window will show the camera's current network settings, allowing admin users to adjust the settings as needed.
- To access the camera's web page, go to the IP Config page and click on the 'View Camera Website'.
- To save the changes made to the camera's setting, input the username and password of the camera and click Apply.

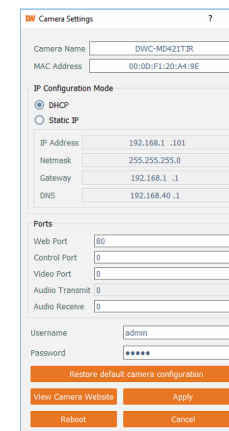

Port forwarding has to be set in your network's router for external access to the camera.

STEP 7 - WEB VIEWER

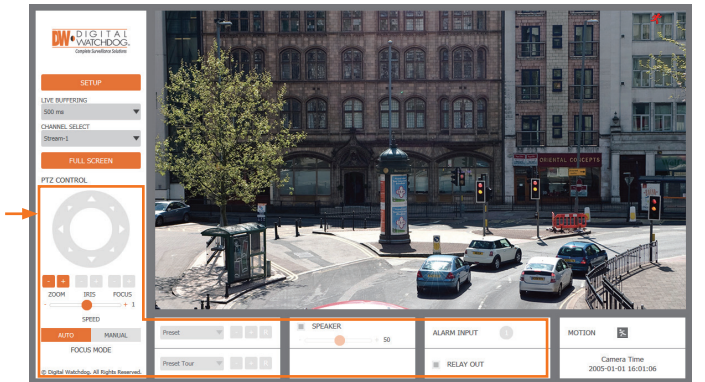

The GUI display may differ by camera models.

NOTE: Chrome browser is recommended for IVA configuration.

Once the camera's network settings have been setup properly, you can access the camera's web viewer using the DW IP Finder.

To open the camera's web viewer:

- Find the camera using the DW IP Finder.
- Double-click on the camera's view in the results table.
- Press the 'View Camera Website'. The camera's web viewer will open up in your default web browser.
- Enter the camera's username and password you setup in the DW IP Finder. If you did not setup a new username and password via the DW IP Finder, you will not be able to view video from the camera. A message will direct you to setup a new password for the camera to view video.

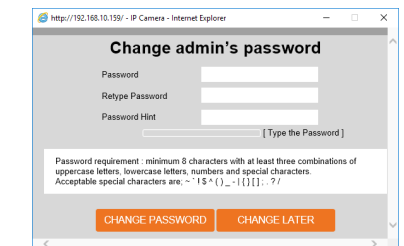

- When accessing the camera for the first time, install the VLC player for web files to view video from the camera.

NOTE: 32bit version of the VLC player must be installed. If you are using a 64bit system, uninstall the previous 64bit version and reinstall using the 32bit version.

NOTE: Some menu options may not be available based on the camera model. See the full manual for more information.