

Structured Media™ Centers
 Cat. No. 47605
 INSTALLATION INSTRUCTIONS



PK-93104-10-00-0F

Leviton's Structured Media™ Centers (SMC) make running cable and managing media both simple and cost-effective. Designed to provide a central distribution point for all your home or small office technologies, the SMCs accommodate: networking, fax, internet, DSL and cable modems, multi-line telephones, security camera, coaxial cable, satellite video distribution, and more.

NOTE: Prior to installation, check the part list on pg. 2, to insure that all parts are included with your product.

Tools needed to install your Media Enclosure:

- Slotted/Phillips Screwdriver/Power Drill
- Utility Knife

INSTALLING YOUR SMC MEDIA ENCLOSURE

Leviton's Structured Media™ Centers are designed to be flush mounted on center between 16" (40.6 cm) wall studs, but they may also be surface mounted.

Step 1

Remove knockouts before mounting the enclosure into the wall. Use the supplied foam grommets with knockout openings to protect cables.

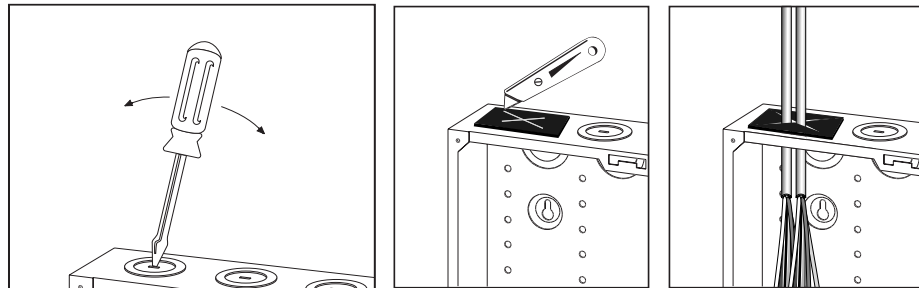

Grommet Placement

- Place 1 foam grommet over each knockout.
- With a utility knife, cut an "X" through each grommet.

Knockout Removal

Step 2 Bending out tabs on SMC:

Leviton's Structured Media™ Centers offer a tab feature which can be used when the SMC is flush mounted on center between 16" (40.6 cm) wall studs.

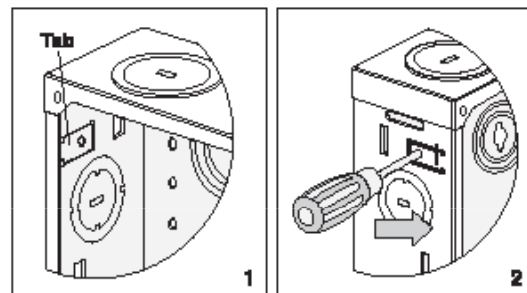

- Insert screwdriver into tab hole from the out side of the SMC Center, as shown in diagram #2 on the left.
- Push screwdriver right/left to bent out tab, as shown in diagram #3 on the left.
- Place 1 foam grommet over each tab hole opening on the inside of the enclosure, as shown in diagram #4 on the left.

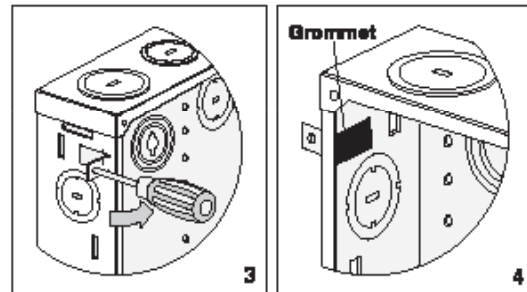

Grommet

Step 3 Mounting the SMC:

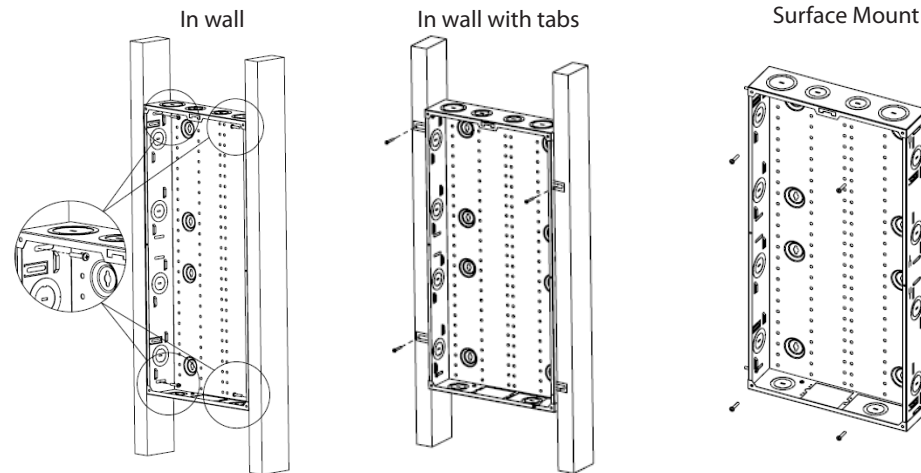

Step 4 Grounding the SMC

Establish an appropriate ground wire between the grounding screw and the AC power ground point. A minimum of No. 10, solid conductor, bare copper wire is recommended to ground the unit.

WARNING: PROPER GROUNDING OF THE SMC IS AN ELECTRICAL SAFETY PRECAUTION. PROPER GROUNDING OF THE UNIT SHOULD BE VERIFIED BY A QUALIFIED ELECTRICIAN AND COMPLIANT WITH THE NATIONAL ELECTRICAL CODE.

A cardboard mudguard has been provided with the packaging to protect the SMC enclosure during installation. Use it after the rough in phase to protect the SMC and wiring from dust and overspray until trim out.

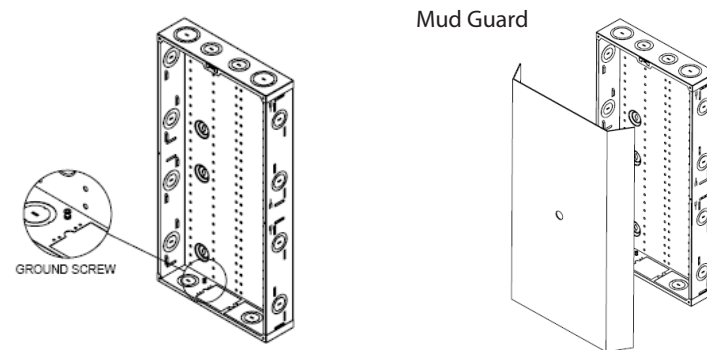

Step 5 Installing the SMC Cover

Two distinct covers are available for Leviton's Structured Media Centers: the flush-mount cover and the hinged cover. The hinged cover offers an optional lock.

Flush-Mount Cover Installation

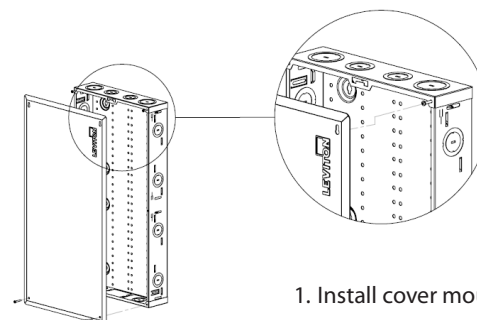

- Install cover mounting screws.

Step 5 Cont.

Hinge Cover Installation

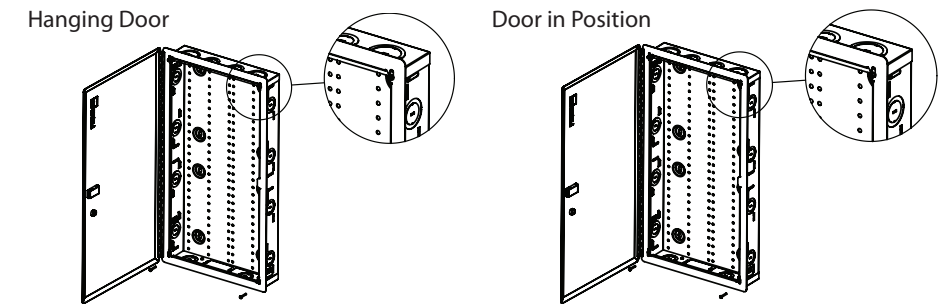

- Attach top cover mounting screws to enclosure (do not tighten all the way).
- Hang door using keyed holes to hang cover onto enclosure.
- Install remaining screws and tighten all screws to complete assembly.

NOTE:

Leviton recommends installing the optional lock prior to mounting the hinged cover.

Optional Lock (PN# 5L000-LOK)

- Remove the plastic plug from the SMC hinged cover by pushing in the plug tabs with a screwdriver.
- Insert lock tumbler (A) into the opening.
- Screw on the nut (B) to secure the lock tumbler in the SMC.
- Select the 90° limit washer (C) and install as shown.
- Place the latch (D) on the back of the tumbler. Ensure latch step is towards the door.
NOTE: Make sure the latch and the SMC frame edge tab overlap.
- Insert and tighten the screw (E) into the back of the lock tumbler.
- Check operation with supplied keys (F).

Outside Enclosure View

Inside Enclosure View

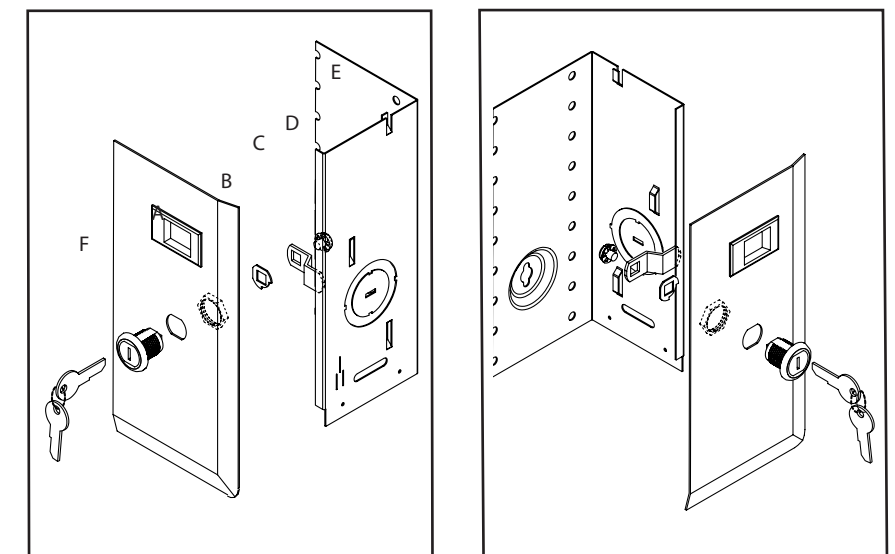

CAUTION: THE SMC IS A DISTRIBUTION DEVICE FOR LOW-VOLTAGE WIRING SYSTEMS. IT IS NOT DESIGNED TO BE USED AS AN AC POWER DISTRIBUTION PANEL.

SMC 140 AND ACCESSORIES

47605-14E

Parts Included:

- (4) #10 x 1" wall mounting screws
- (6) Self-healing foam grommets
- (1) Corrugated mud guard (Included with packaging supplied)

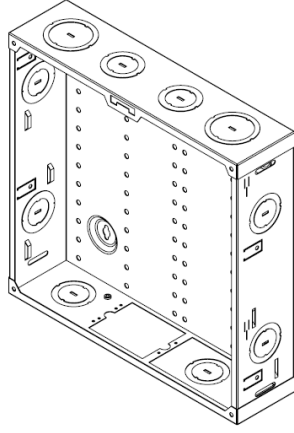

47605-14C

Parts Included:

- (4) #8-32 x 1" cover mounting screws

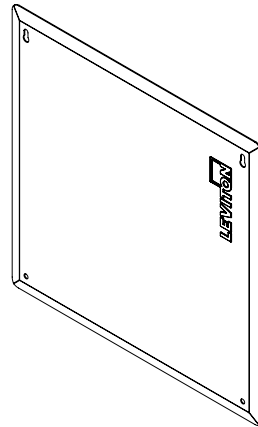
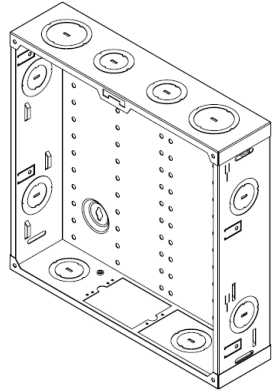
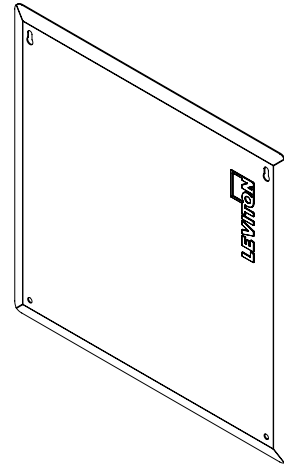

47605-140

Parts Included:

- (4) #10 x 1" wall mounting screws
- (4) #8-32 x 1" cover mounting screws
- (6) Self-healing foam grommets
- (1) Flush cover
- (1) Corrugated mud guard (Included with packaging supplied)

47605-14P

Parts Included:

- (4) #8-32 x 1" cover mounting screws

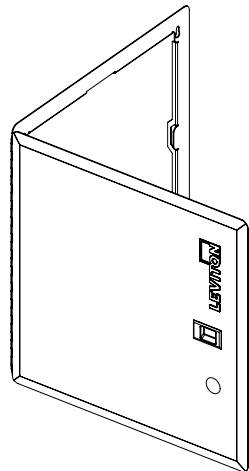

5L000-LOK

Parts Included:

- (1) Tumbler
- (1) Nut
- (1) Limit Washer
- (1) Latch
- (1) Latch screw
- (2) Keys

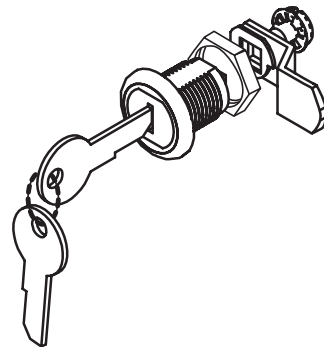

SMC 280 AND ACCESSORIES

47605-28N

Parts Included:

- (4) #10 x 1" wall mounting screws
- (6) Self-healing foam grommets
- (1) Corrugated mud guard (Included with packaging supplied)

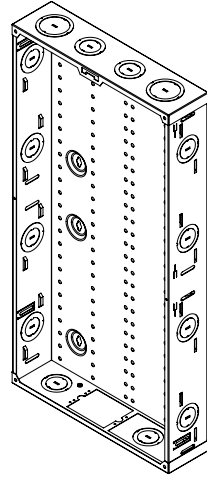

47605-28W

Parts Included:

- (4) #10 x 1" wall mounting screws
- (4) #8-32 x 1" cover mounting screws
- (6) Self-healing foam grommets
- (1) Flush cover
- (1) Corrugated mud guard (Included with packaging supplied)

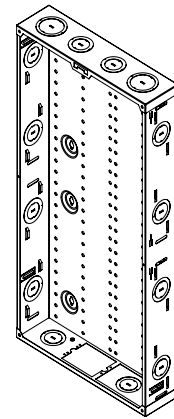

47605-28P

Parts Included:

- (4) #8-32 x 1" cover mounting screws

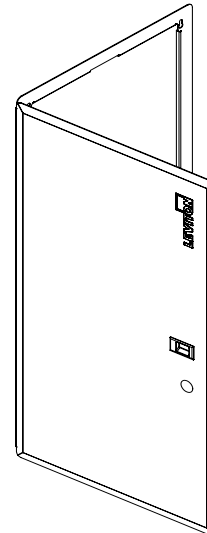

47605-F28

Parts Included:

- (4) #8-32 x 1" cover mounting screws

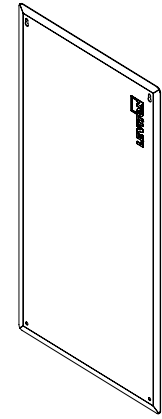
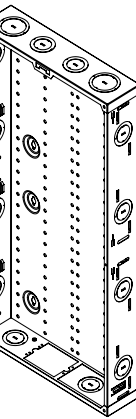
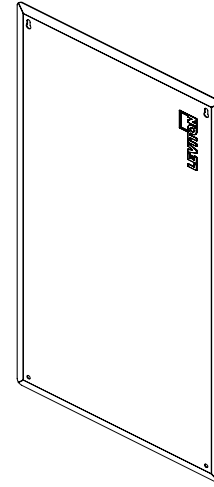

47612-28B

Optional 28" Extender Bracket

(For Reference Only)

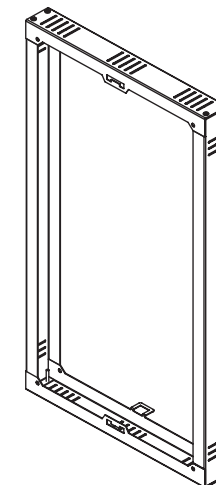

SMC 420 AND ACCESSORIES

47605-42N

Parts Included:

- (6) #10 x 1" wall mounting screws
- (6) Self-healing foam grommets
- (1) Corrugated mud guard (Included with packaging supplied)

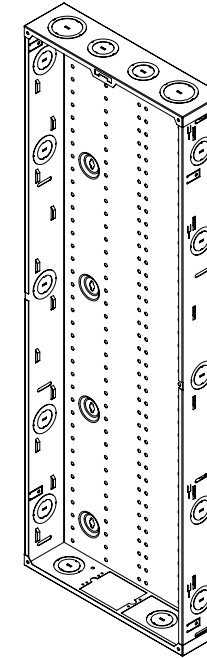

47605-42W

Parts Included:

- (6) #10 x 1" wall mounting screws
- (6) #8-32 x 1" cover mounting screws
- (6) Self-healing foam grommets
- (1) Flush cover
- (1) Corrugated mud guard (Included with packaging supplied)

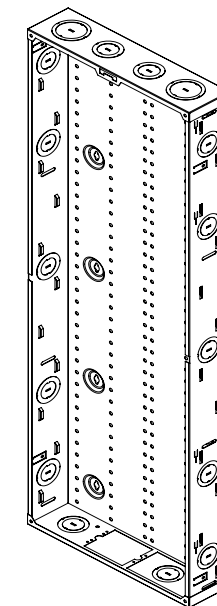

47605-F42

Parts Included:

- (6) #8-32 x 1" cover mounting screws

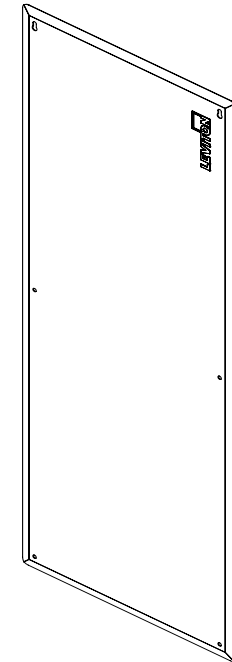

47605-42P

Parts Included:

- (6) #10 x 1" wall mounting screws
- (6) #8-32 x 1" cover mounting screws
- (6) Self-healing foam grommets
- (1) Flush cover
- (1) Corrugated mud guard (Included with packaging supplied)

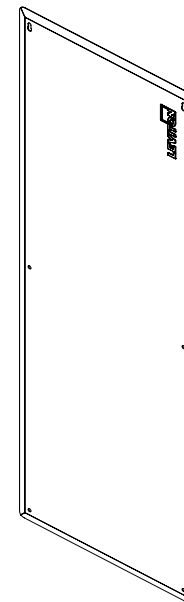

47612-42B

Optional 42" Extender Bracket
(For Reference Only)

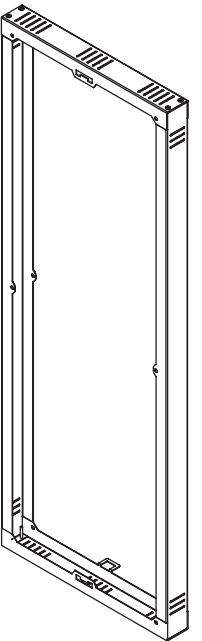

47605-42P

Parts Included:

- (6) #8-32 x 1" cover mounting screws

