

---

## Alarm.com Video Doorbell (ADC-VDB770) - Installation Guide

Use this guide to assist with the installation of your VDB770 doorbell camera.

### Pre-installation checklist

Media, iframe, embed and object tags are not supported inside of a PDF.

**Important:** A Video Analytics service package and the *Doorbell Cameras* add-on is required to enroll the ADC-VDB770. For more information about which service packages have Video Analytics, see [What service packages can support enrolling the ADC-VDB770?](#)

- ADC-VDB770 and included accessories
- Wire crimping tool
- Wi-Fi connection to broadband (Cable, DSL, or Fiber Optic) internet



- A computer, tablet, or smartphone with Wi-Fi is required if the router does not have the Wi-Fi Protected Setup (WPS) feature
- Verify the original doorbell rings the chime when you press it.
- Verify that your transformer meets the minimum voltage of 16 VAC and minimum power of 10 VA; specifications are often written directly on the transformer
- A compatible chime. For more information, see [What types of chimes are compatible with the ADC-VDB770](#)

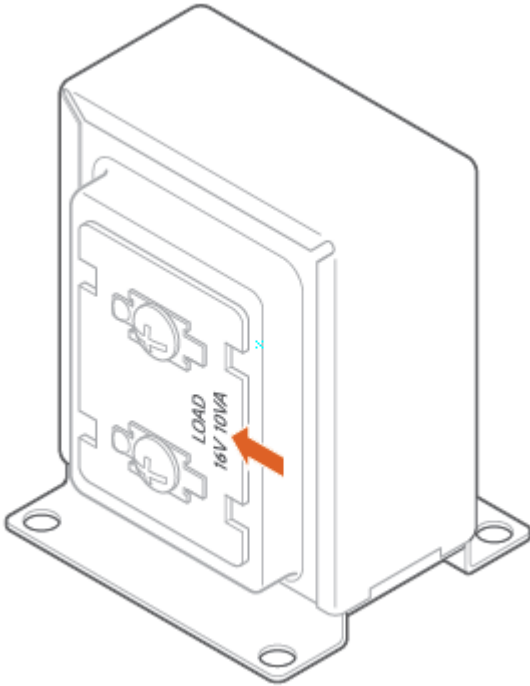

## Installation



## Install the power module

Media, iframe, embed and object tags are not supported inside of a PDF.

1. Verify that the electricity is turned off at the transformer before installing the power module. Locate your chime box and remove the cover.



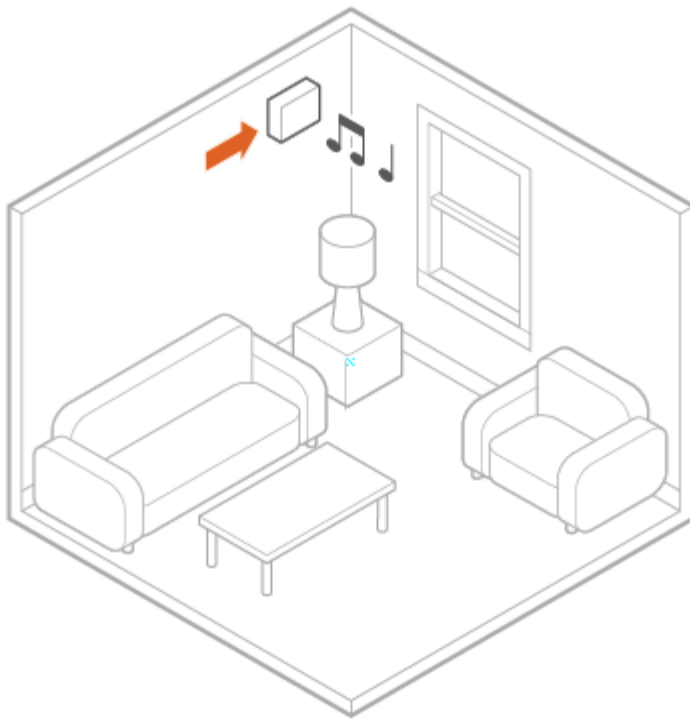

2. Note the existing wire connections (e.g., the wires may be connected to the Front or Rear doorbell terminal); you will want to connect to the same doorbell terminal in the next step. Loosen the screws on the chime associated with the transformer and doorbell. Set the wires aside.
3. Take the power module and hook the curved white wires onto the screw terminals (it does not matter which white wire goes to the transformer terminal and which goes to the doorbell terminal). Tighten the screws.
4. Using a crimp tool and the wire connectors provided, connect the wires that were set aside to the straight gray wires of the power module.
5. Affix the power module to the side of the chime using the included adhesive. Replace the chime cover.



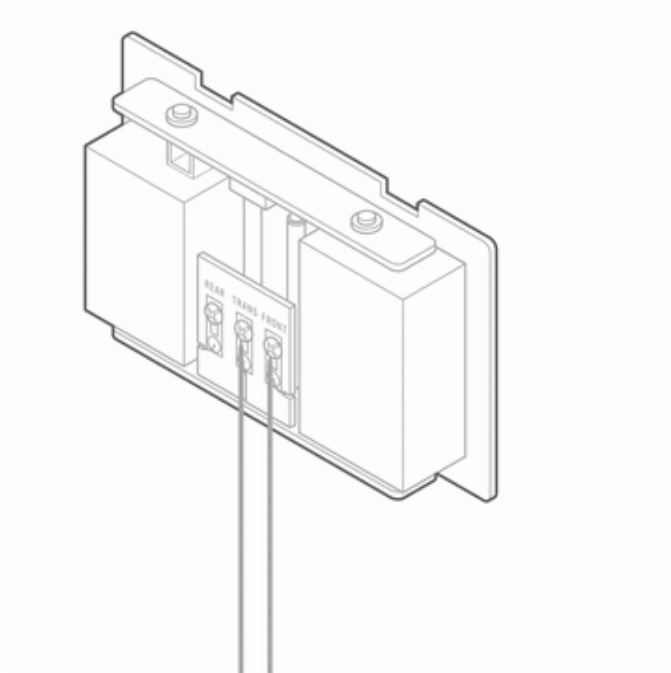

**Note:** The power module must be used in every installation regardless of the chime type. The power module is used to prevent the chime from buzzing or humming, and it helps ensure sufficient power is provided to the Alarm.com Video Doorbell.



## Install the Alarm.com Video Doorbell

Media, iframe, embed and object tags are not supported inside of a PDF.

1. Remove the existing doorbell from the wall and disconnect the wires. Secure the wires so that they can be connected in a later step. If possible, verify that the Alarm.com Video Doorbell will be out of direct sunlight in hotter climates. For more information, see [Can the ADC-VDB770 be used in climates that reach higher or lower than the temperature rating?](#)



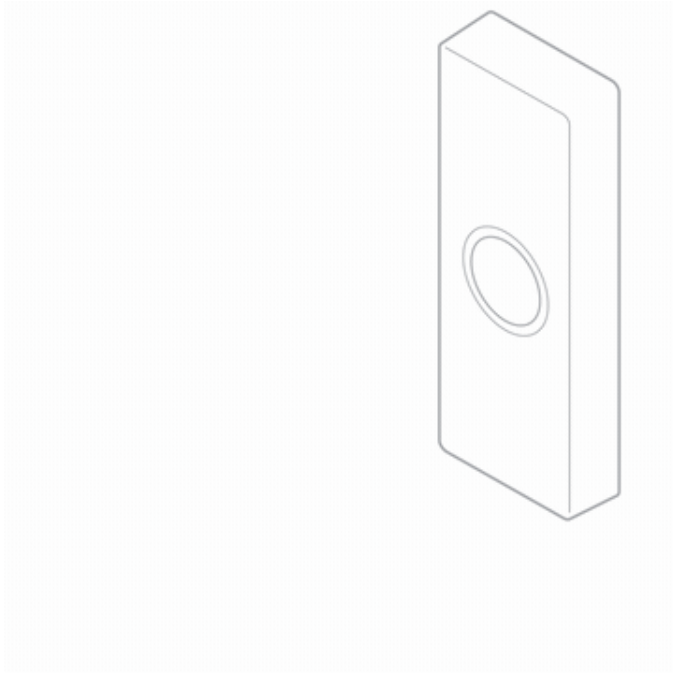

2. At the installation location, an angled mounting bracket can be used to modify the field of view. Choose a mounting bracket type best suited for your installation setup. Installation scenarios corresponding to mounting bracket types A, B, and C are provided below to guide your decision.



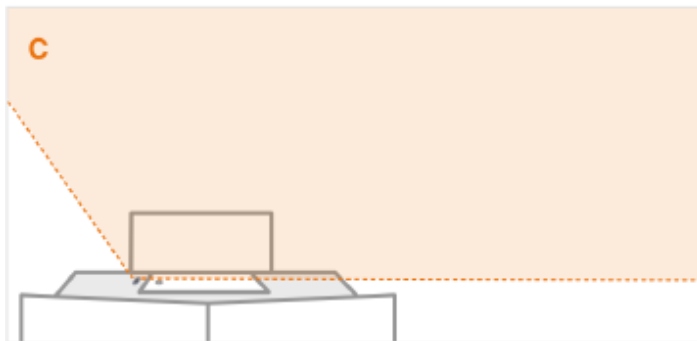
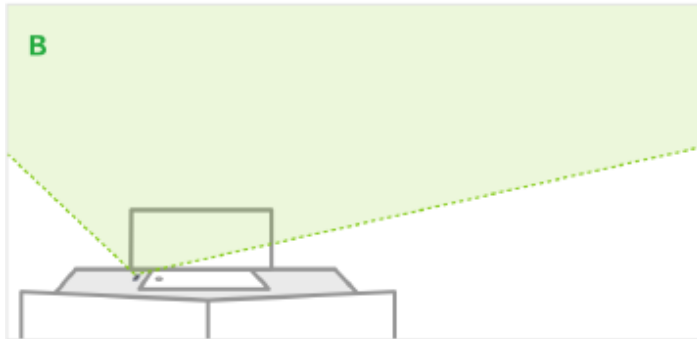
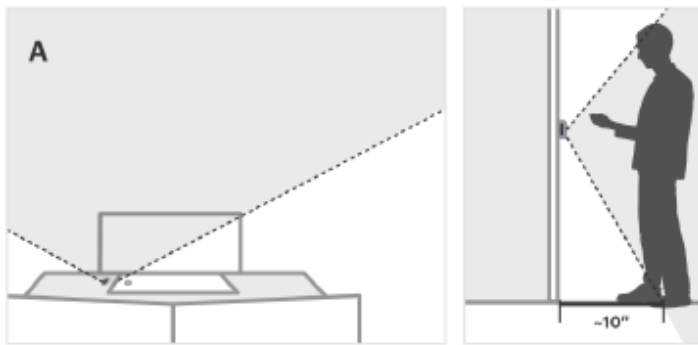

3. Thread the existing wires through the mounting bracket. Install the mounting bracket to the wall using the included wall screws (and anchors, if needed for the mounting surface).







4. Thread the wire extenders through the backplate. Remove the wire caps.



5. Crimp the two wires coming through the backplate to the existing wires threaded through the mounting bracket.



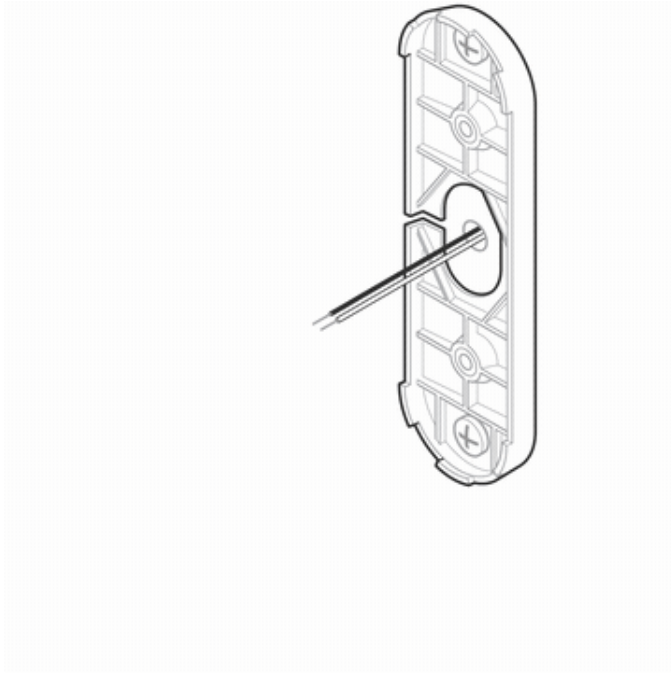

6. Install the doorbell backplate to the mounting bracket using the included machine screws.

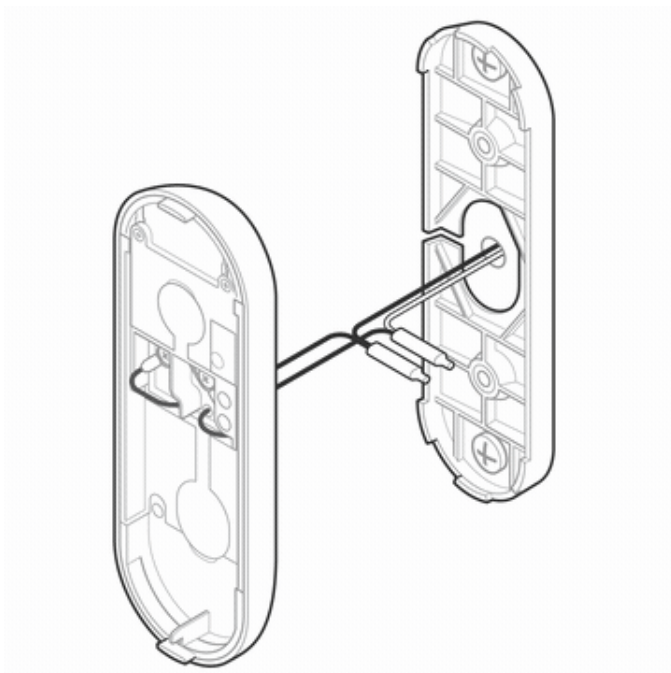

7. Attach the doorbell to the backplate by aligning and pushing together until it clicks into place and the connection is well sealed.
8. Turn the electricity back on. Check that the doorbell camera's light is flashing white after the boot process is complete.





**Note:** If the LED is solid red after the boot-up process is complete, press and hold the main button until the light begins alternating green and red.

## Connect the ADC-VDB770 to the network

### AP Mode (recommended)

1. The camera is in Access Point (AP) mode when the button LED is blinking white. If necessary, access AP mode by holding down the doorbell button for 35-40s and release when the LED turns to blinking white.
2. Using a Wi-Fi-capable device (e.g., smartphone or computer), find and connect to the camera's network; the SSID should have the format ADC-VDB770 (XX:YY:ZZ) where XX:YY:ZZ is the last 6 characters of the MAC address, which is printed on the included reference card.
3. On the same device, open a web browser and enter <http://vdb770install> or **192.168.1.1** in the web address field. Follow the on-screen instructions to add the ADC-VDB770 to the Wi-Fi network. Verify the LED turns solid green, indicating the connection is complete.

### WPS Mode (alternate)

**Note:** Use WPS mode if you have easy access to the Wi-Fi router and the router has the WPS feature enabled. Note that some Internet Service Providers disable the WPS feature on customer routers. AP mode is the most reliable method for installing this device.

1. After the boot process is complete (the camera's LED will be blinking white), hold down the doorbell button for 30-35s and release when the LED begins to blink blue.
2. Activate WPS Mode on the router. The router will begin to connect to the Wi-Fi network. Verify the LED turns to



solid green, indicating the connection is complete.

## Enroll the Video Doorbell to the account

1. Add the device to the account by selecting the account in MobileTech, by using the customer Mobile App, or by using a web browser and entering the following web address: [www.alarm.com/addcamera](http://www.alarm.com/addcamera).
2. Select the Video Doorbell from the video device list or enter in its MAC address to begin adding the device. The device's MAC address is located on the included reference card.
3. Follow the on-screen instructions to finish adding the device.



## Configure the Video Doorbell

- Select the appropriate chime type for the installation
- Select the appropriate mounting bracket option
- Set up all desired recording rules and notifications







For more details about how to change the chime type and mounting bracket settings, see [ADC-VDB770 enrollment best practices](#).

For more information about how to configure a Video Analytics rule for the ADC-VDB770 after it is enrolled, see [Configure a Video Analytics rule for an Alarm.com doorbell camera](#).



## Status light guide

LED pattern	Description
Off 	Power off
Solid red 	No local or Internet connection
Blinking red 	Power on, camera booting



LED pattern	Description
<p data-bbox="120 260 256 289">Solid green</p> 	<p data-bbox="824 310 1120 340">Connected to Alarm.com</p>
<p data-bbox="120 491 289 520">Blinking green</p> 	<p data-bbox="824 541 1127 571">Local network connection</p>
<p data-bbox="120 730 360 760">Double-blinking blue</p> 	<p data-bbox="824 722 1153 751">Unable to ring indoor chime</p> <p data-bbox="824 789 1438 898">For more information about what causes this status, see <a href="#">What does the double-blinking blue LED on the ADC-VDB770 mean?</a>.</p>
<p data-bbox="120 982 263 1012">Solid yellow</p> 	<p data-bbox="824 974 1136 1003">Cool-Down mode is active</p> <p data-bbox="824 1041 1468 1150">For more information about what causes this status, see <a href="#">The ADC-VDB770 is warm to the touch and has a solid yellow LED (Cool-Down mode)</a>.</p>
<p data-bbox="120 1226 272 1255">Blinking blue</p> 	<p data-bbox="824 1272 1370 1302">WPS mode (press and hold button for 30-35s)</p>
<p data-bbox="120 1457 282 1486">Blinking white</p> 	<p data-bbox="824 1486 1435 1554">Wi-Fi Access point mode (press and hold button for 35-40s)</p>



LED pattern	Description
Blinking yellow 	Camera power cycling (press and hold button for 40-45s)
Alternating red & green 	Camera resetting to factory default (press and hold button for 45-50s)

**Note:** If the indoor chime is enabled for the device, holding down the button will trigger a single indoor chime immediately after being pressed. If desired, the indoor chime can be disabled through the Customer Website before pressing the button to initiate one of the above modes.

## Troubleshooting

1. If there are issues connecting the Video Doorbell to the account, power cycle the camera by holding down the doorbell button until the LED starts blinking yellow (~45-50s) and then releasing the button. After the device reboots, try connecting again.
2. If issues persist, factory reset the Video Doorbell by pressing and holding the doorbell button until the LED starts blinking red and green (~50s). The device will reboot with factory defaults.

**Important:** If the device was previously installed to an Alarm.com account, it will need to be deleted before it can be installed again.

If the mounting bracket needs to be replaced with a different angled variety to improve the field of view, uninstall the backplate, replace the mounting bracket (while leaving the wires connected), and reinstall the backplate to the new mounting bracket.



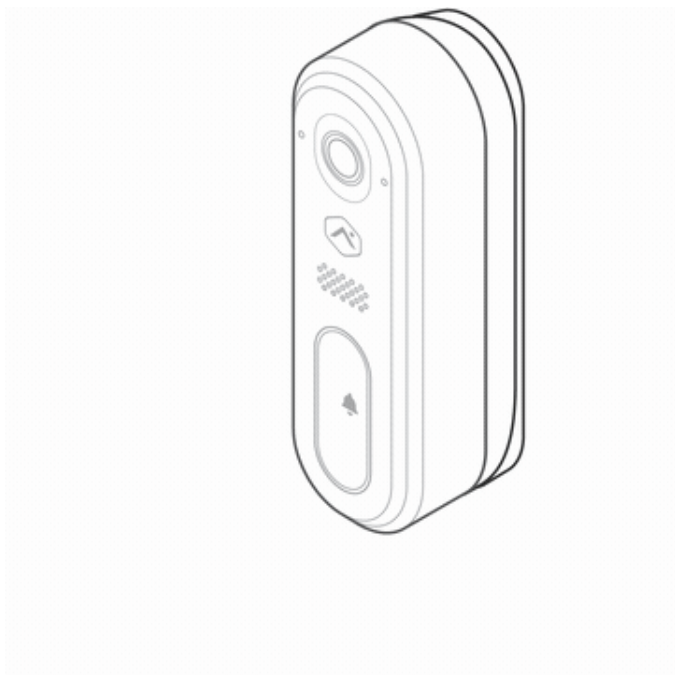

If the indoor chime does not make sound when it should, see [The indoor chime does not make sound when a guest rings the ADC-VDB770.](#)

