



LCD Monitor

User Manual

Legal Information

©2021 Hangzhou Hikvision Digital Technology Co., Ltd. All rights reserved.

About this Manual

The Manual includes instructions for using and managing the Product. Pictures, charts, images and all other information hereinafter are for description and explanation only. The information contained in the Manual is subject to change, without notice, due to firmware updates or other reasons. Please find the latest version of this Manual at the Hikvision website (<https://www.hikvision.com/>).

Please use this Manual with the guidance and assistance of professionals trained in supporting the Product.

Trademarks

HIKVISION and other Hikvision's trademarks and logos are the properties of Hikvision in various jurisdictions.

Other trademarks and logos mentioned are the properties of their respective owners.



: The terms HDMI and HDMI High-Definition Multimedia Interface, and the HDMI Logo are trademarks or registered trademarks of HDMI Licensing Administrator, Inc. in the United States and other countries.

Disclaimer

TO THE MAXIMUM EXTENT PERMITTED BY APPLICABLE LAW, THIS MANUAL AND THE PRODUCT DESCRIBED, WITH ITS HARDWARE, SOFTWARE AND FIRMWARE, ARE PROVIDED "AS IS" AND "WITH ALL FAULTS AND ERRORS". HIKVISION MAKES NO WARRANTIES, EXPRESS OR IMPLIED, INCLUDING WITHOUT LIMITATION, MERCHANTABILITY, SATISFACTORY QUALITY, OR FITNESS FOR A PARTICULAR PURPOSE. THE USE OF THE PRODUCT BY YOU IS AT YOUR OWN RISK. IN NO EVENT WILL HIKVISION BE LIABLE TO YOU FOR ANY SPECIAL, CONSEQUENTIAL, INCIDENTAL, OR INDIRECT DAMAGES, INCLUDING, AMONG OTHERS, DAMAGES FOR LOSS OF BUSINESS PROFITS, BUSINESS INTERRUPTION, OR LOSS OF DATA, CORRUPTION OF SYSTEMS, OR LOSS OF DOCUMENTATION, WHETHER BASED ON BREACH OF CONTRACT, TORT (INCLUDING NEGLIGENCE), PRODUCT LIABILITY, OR OTHERWISE, IN CONNECTION WITH THE USE OF THE PRODUCT, EVEN IF HIKVISION HAS BEEN ADVISED OF THE POSSIBILITY OF SUCH DAMAGES OR LOSS.

YOU ACKNOWLEDGE THAT THE NATURE OF THE INTERNET PROVIDES FOR INHERENT SECURITY RISKS, AND HIKVISION SHALL NOT TAKE ANY RESPONSIBILITIES FOR ABNORMAL OPERATION, PRIVACY LEAKAGE OR OTHER DAMAGES RESULTING FROM CYBER-ATTACK, HACKER ATTACK, VIRUS INFECTION, OR OTHER INTERNET SECURITY RISKS; HOWEVER, HIKVISION WILL PROVIDE TIMELY TECHNICAL SUPPORT IF REQUIRED.

YOU AGREE TO USE THIS PRODUCT IN COMPLIANCE WITH ALL APPLICABLE LAWS, AND YOU ARE SOLELY RESPONSIBLE FOR ENSURING THAT YOUR USE CONFORMS TO THE APPLICABLE LAW. ESPECIALLY, YOU ARE RESPONSIBLE, FOR USING THIS PRODUCT IN A MANNER THAT DOES NOT

LCD Monitor User Manual

INFRINGE ON THE RIGHTS OF THIRD PARTIES, INCLUDING WITHOUT LIMITATION, RIGHTS OF PUBLICITY, INTELLECTUAL PROPERTY RIGHTS, OR DATA PROTECTION AND OTHER PRIVACY RIGHTS. YOU SHALL NOT USE THIS PRODUCT FOR ANY PROHIBITED END-USES, INCLUDING THE DEVELOPMENT OR PRODUCTION OF WEAPONS OF MASS DESTRUCTION, THE DEVELOPMENT OR PRODUCTION OF CHEMICAL OR BIOLOGICAL WEAPONS, ANY ACTIVITIES IN THE CONTEXT RELATED TO ANY NUCLEAR EXPLOSIVE OR UNSAFE NUCLEAR FUEL-CYCLE, OR IN SUPPORT OF HUMAN RIGHTS ABUSES.

IN THE EVENT OF ANY CONFLICTS BETWEEN THIS MANUAL AND THE APPLICABLE LAW, THE LATTER PREVAILS.

Regulatory Information

FCC Information

Please take attention that changes or modification not expressly approved by the party responsible for compliance could void the user's authority to operate the equipment.

FCC compliance: This equipment has been tested and found to comply with the limits for a Class B digital device, pursuant to part 15 of the FCC Rules. These limits are designed to provide reasonable protection against harmful interference in a residential installation. This equipment generates, uses and can radiate radio frequency energy and, if not installed and used in accordance with the instructions, may cause harmful interference to radio communications. However, there is no guarantee that interference will not occur in a particular installation. If this equipment does cause harmful interference to radio or television reception, which can be determined by turning the equipment off and on, the user is encouraged to try to correct the interference by one or more of the following measures:

- Reorient or relocate the receiving antenna.
- Increase the separation between the equipment and receiver.
- Connect the equipment into an outlet on a circuit different from that to which the receiver is connected.
- Consult the dealer or an experienced radio/TV technician for help.

FCC Conditions

This device complies with part 15 of the FCC Rules. Operation is subject to the following two conditions:

1. This device may not cause harmful interference.
2. This device must accept any interference received, including interference that may cause undesired operation.

EU Conformity Statement



This product and - if applicable - the supplied accessories too are marked with "CE" and comply therefore with the applicable harmonized European

standards listed under the EMC Directive 2014/30/EU, the RoHS Directive 2011/65/EU.



2012/19/EU (WEEE directive): Products marked with this symbol cannot be disposed of as unsorted municipal waste in the European Union. For proper recycling, return this product to your local supplier upon the purchase of equivalent new equipment, or dispose of it at designated collection points. For more information see: <http://www.recyclethis.info>.



2006/66/EC (battery directive): This product contains a battery that cannot be disposed of as unsorted municipal waste in the European Union. See the product documentation for specific battery information. The battery is marked with this symbol, which may include lettering to indicate cadmium (Cd), lead (Pb), or mercury (Hg). For proper recycling, return the battery to your supplier or to a designated collection point. For more information see: <http://www.recyclethis.info>.

Industry Canada ICES-003 Compliance

This device meets the CAN ICES-3 (B)/NMB-3(B) standards requirements.



Preface

Applicable Models

This manual is applicable to 4K monitors of the following sizes: 43 inches, and 55 inches, 65 inches, and 75 inches.

Symbol Conventions

The symbols that may be found in this document are defined as follows.

| Symbol | Description |
|--|---|
|  Danger | Indicates a hazardous situation which, if not avoided, will or could result in death or serious injury. |
|  Caution | Indicates a potentially hazardous situation which, if not avoided, could result in equipment damage, data loss, performance degradation, or unexpected results. |
|  Note | Provides additional information to emphasize or supplement important points of the main text. |

Safety Instruction

Caution

- Proper configuration of all passwords and other security settings is the responsibility of the installer and/or end-user.
- In the use of the product, you must be in strict compliance with the electrical safety regulations of the nation and region. Please refer to technical specifications for detailed information.
- Input voltage should meet both the SELV (Safety Extra Low Voltage) and the Limited Power Source with 100~240 VAC according to the IEC60950-1 standard. Please refer to technical specifications for detailed information.
- Do not connect several devices to one power adapter as adapter overload may cause overheating or a fire hazard.
- Please make sure that the plug is firmly connected to the power socket.
- If smoke, odor or noise rise from the device, turn off the power at once and unplug the power cable, and then please contact the service center.

 **Warning**

- The equipment must be connected to an earthed mains socket-outlet.
- CAUTION: Risk of explosion if the battery is replaced by an incorrect type.
- Improper replacement of the battery with an incorrect type may defeat a safeguard (for example, in the case of some lithium battery types).
- Do not dispose of the battery into fire or a hot oven, or mechanically crush or cut the battery, which may result in an explosion.
- Do not leave the battery in an extremely high temperature surrounding environment, which may result in an explosion or the leakage of flammable liquid or gas.
- Do not subject the battery to extremely low air pressure, which may result in an explosion or the leakage of flammable liquid or gas.
- Dispose of used batteries according to the instructions.
- Never place the equipment in an unstable location. The equipment may fall, causing serious personal injury or death.
- NEVER place items that might tempt children to climb, such as toys and remote controls, on the top of the equipment or furniture on which the equipment is placed.

Contents

| | |
|---|-----------|
| Chapter 1 Introduction | 1 |
| 1.1 Overview | 1 |
| 1.2 Key Features | 1 |
| 1.3 Panel Buttons | 1 |
| 1.4 Rear Panel Interface | 2 |
| 1.5 Remote Control | 3 |
| 1.5.1 Remote Control Panel | 3 |
| 1.5.2 Remote Control Operation | 5 |
| Chapter 2 Terminal Operations | 6 |
| 2.1 Switch Signal Source | 6 |
| 2.2 Configure Image Parameters | 6 |
| 2.3 Configure Audio Settings | 9 |
| 2.4 Configure Screen ID | 10 |
| 2.4.1 Manually Configure Screen ID | 10 |
| 2.4.2 Automatically Configure Screen ID | 10 |
| 2.5 Configure Overheat Alarm | 11 |
| 2.6 Menu Interface Settings | 12 |
| 2.7 Power Settings | 12 |
| 2.8 System Maintenance | 13 |
| Chapter 3 Client Operations | 14 |
| 3.1 Log into the Client | 14 |
| 3.2 Configure Serial Port | 14 |
| 3.3 Startup/Shutdown | 14 |
| 3.4 Switch Input Source | 15 |

Chapter 1 Introduction

1.1 Overview

The LCD monitor adopts Mstar ACE-5 auto-coloring and image-enhancing engine to improve image contrast, detail, edge, etc. It is an ideal choice for financial institution, metro, train station, airport and exhibition.

1.2 Key Features

- Up to 3840 × 2160 resolution.
- Adopts 3D digital comb filter and 3D noise reduction technology.
- Programmable 12-bit RGB gamma correction.
- Complete factory settings.
- Software spread spectrum technology reduces EMI radiation.
- Fan-less design saves energy and reduces noise.
- Supports one-touch quiescence, and high temperature alarm.
- Software update via USB interface.
- 3.5 mm audio input.
- Supports 7 × 24 hours working mode.
- Adopts 2 MACE color correction engines to improve image contrast, detail, edge, etc.
- Provides multiple video and audio input interfaces, including DP, DVI, HDMI and VGA.

1.3 Panel Buttons

Panel buttons are for illustration only. See details in the following figure and table.

Note

Panel buttons are enabled by default, you can enter **Menu → Other Setting → Keypad** to disable panel buttons.

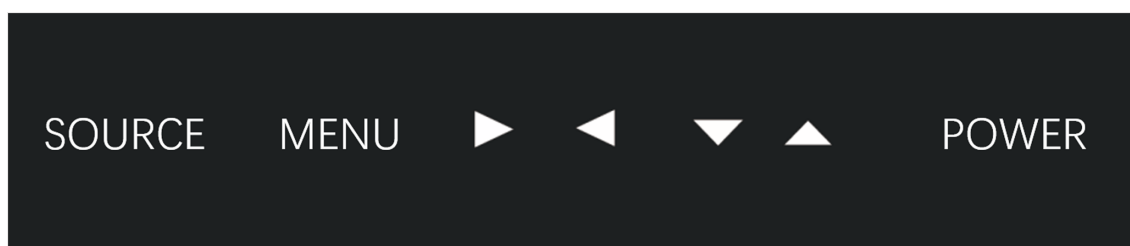

Figure 1-1 Panel Buttons

Table 1-1 Buttons Description

| Button | Description |
|---------|--|
| SOURCE | Enter Input Source page. |
| MENU | Enter Menu page. |
| ▲/▼/◀/▶ | Move the cursor up/down/left/right. |
| POWER | Press to confirm, or turn on the device. Hold for more than 2 seconds to switch the device to standby mode. |

1.4 Rear Panel Interface

Please view the corresponding rear panel of your monitor.

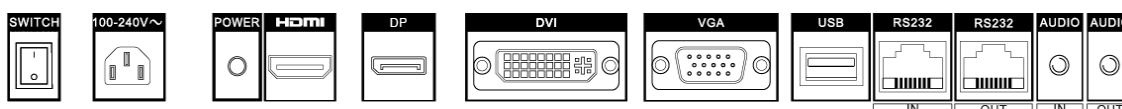

Figure 1-2 Rear Panel of Device 1 (DS-D5043UL-A)

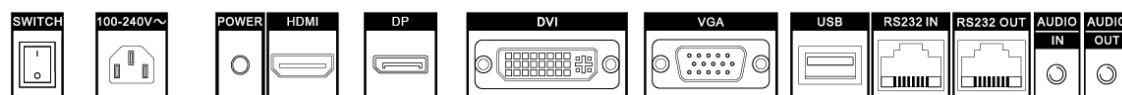

Figure 1-3 Rear Panel of Device 2 (DS-D5055UL-A)

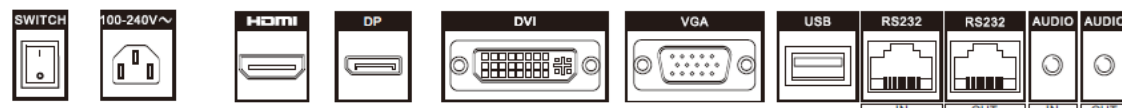

Figure 1-4 Rear Panel of Device 3 (DS-D5065UL-A)

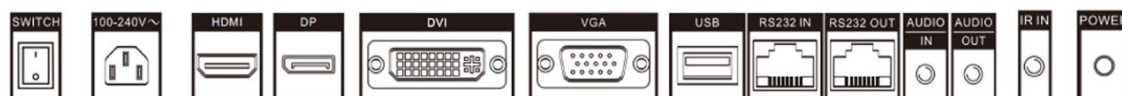

Figure 1-5 Rear Panel of Device 4 (DS-D5055UL-C)

Table 1-2 Description of Rear Panel

| Interface | Description |
|------------------|---|
| SWITCH | Power switch. |
| 100-240V~ | 100 to 240 VAC power supply. |
| POWER | Working status indicator. Turns red when the device is standby. Turns green when the device is working. |
| HDMI | HDMI digital signal input. |
| DP | DP digital signal input |
| DVI | DVI digital signal input. |
| VGA | VGA analog signal input. |
| USB | USB interface. |
| RS232 IN | RS-232 serial port input. |
| RS232 OUT | RS-232 serial port output. |
| AUDIO IN | 3.5 mm audio input. |
| AUDIO OUT | 3.5 mm audio output. |
| IR IN | Infrared input. |

1.5 Remote Control

1.5.1 Remote Control Panel

Refer to the following table for the remote control panel description.

Table 1-3 Description of Remote Control Buttons

| Appearance | Key | Function |
|--|---------|--|
|  | POWER | Power switch. |
| | TEST | Enter the aging test. |
| | MUTE | Turn off/on the sound. |
| | 0-9 | Enter numbers to select the desired screen, or enter the special menu such as factory menu, etc. |
| | FREEZE | Freeze the image. |
| | PIC | Image mode shortcut. |
| | INFO | View system information. |
| | LIGHT | Lighting mode. |
| | ▲/▼/◀/▶ | Up/down/left/right direction keys, select a submenu or set menu parameters. |
| | OK | Confirm |
| | +VOL- | Adjust volume |
| | MENU | Enter/Exit main menu. |
| | SOURCE | Enter Input Source page. |

 **Note**

Buttons of **PLAY**, **STOP**, **PREV/NEXT**, **STOP**, **LIST**, **REPEAT**, **L/R**, **RETURN** and **+CH-** are reserved for use.

1.5.2 Remote Control Operation

If the monitor has an IR receiver at the corner, you shall aim the remote control at the IR receiver. Otherwise, you shall aim the remote control at screen center.

You should operate the remote control within an angle of $\pm 45^\circ$ when aiming at the IR receiver or screen center. Otherwise, the screen may not respond.

In order to achieve better performance, it is recommended to keep the distance between remote control and monitor within 5 meters.

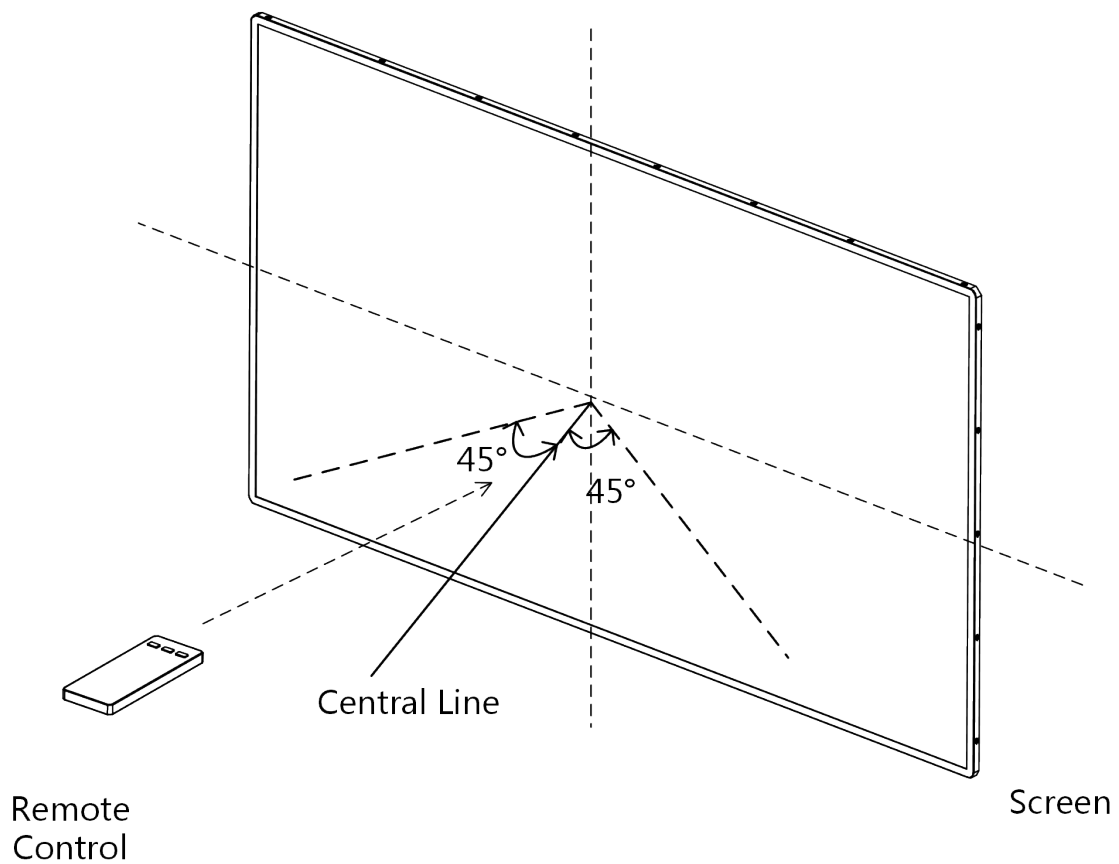

Figure 1-6 Operation of Remote Control

Chapter 2 Terminal Operations

2.1 Switch Signal Source

The monitor can display input signal sources including HDMI, DVI, VGA and DP.

Steps

1. Press **SOURCE** to enter Input Source page.



Figure 2-1 Input Source

2. Press ▼ or ▲ to select the input source.
3. Press **OK** to accomplish the input source selection.

2.2 Configure Image Parameters

Picture Mode

You can switch picture modes and adjust image parameters including contrast, brightness, color, sharpness, and hue.

Enter **Menu** → **Picture Mode** → **Picture Mode** , and select the mode as your desire.

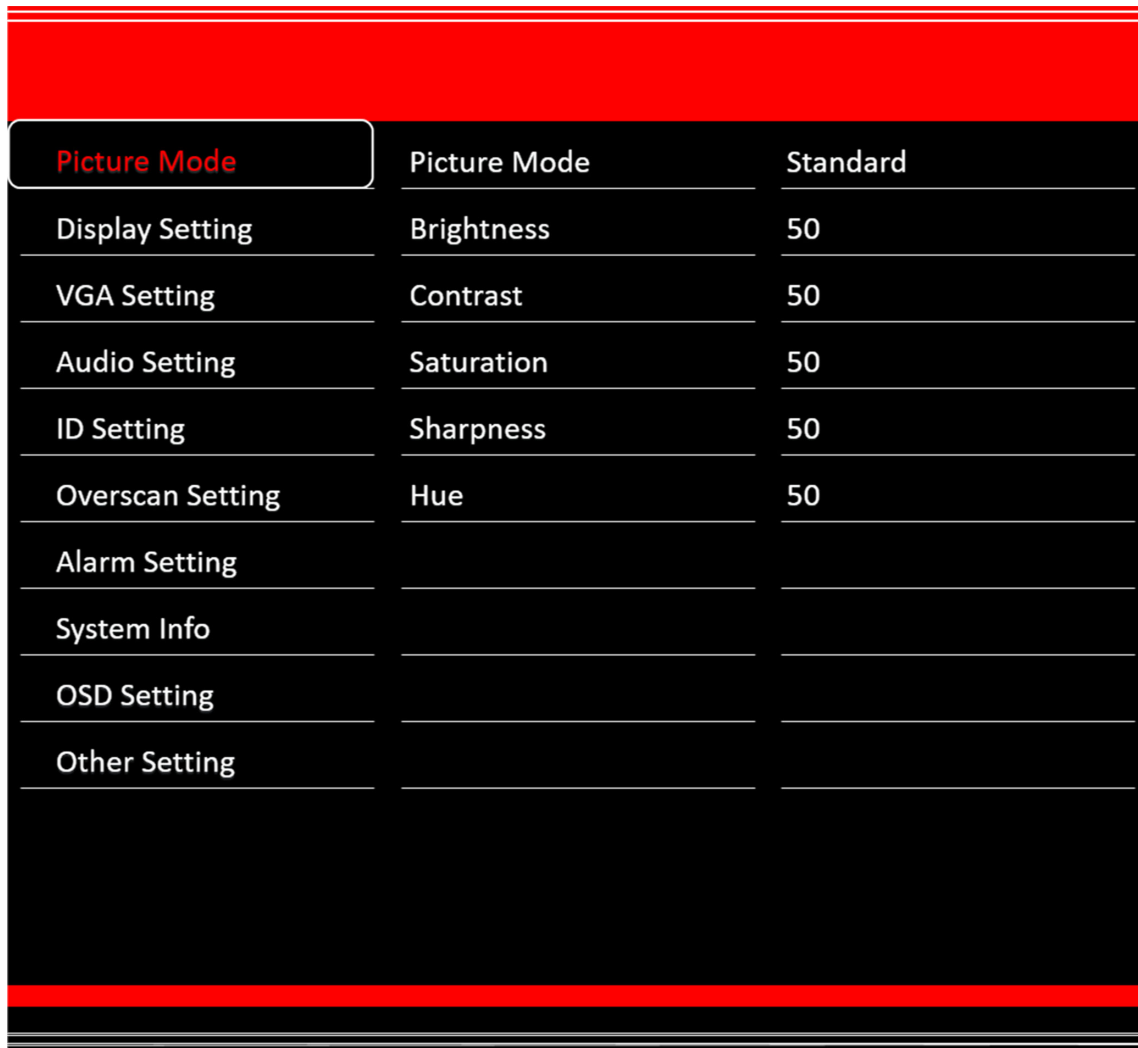

The image shows a screenshot of the LCD Monitor's OSD menu. At the top, there is a red header bar. Below it, the 'Picture Mode' menu is selected and highlighted with a white border. The menu is divided into three columns: 'Picture Mode', 'Picture Mode', and 'Standard'. The 'Picture Mode' column lists various settings, and the 'Standard' column shows the value '50' for several of these settings. The 'Other Setting' row is currently empty.

| Picture Mode | Picture Mode | Standard |
|------------------|--------------|----------|
| Display Setting | Brightness | 50 |
| VGA Setting | Contrast | 50 |
| Audio Setting | Saturation | 50 |
| ID Setting | Sharpness | 50 |
| Overscan Setting | Hue | 50 |
| Alarm Setting | | |
| System Info | | |
| OSD Setting | | |
| Other Setting | | |

Figure 2-2 Picture Mode

Standard

Suitable for a normal environment.

Soft

Suitable for a dark room.

Dynamic

Suitable for a bright room.

User

Set the brightness, contrast, color, or sharpness to adjust display effect.

 **Note**

Adjustable parameters vary depending on the input source you choose. If the parameter bar is blue, it indicates that the parameter is unadjustable under the current input source.

VGA Setting

When you select VGA as the input source, you can adjust VGA parameters to make the picture show in the correct position.

Enter **Menu** → **VGA Setting** to set the parameters as your desire.

| | |
|---------------|-----|
| Manual Adjust | |
| ADC Tune | |
| Row | 50 |
| Column | 50 |
| Clock | 50 |
| Phase | 50 |
| Auto Adjust | Off |

Figure 2-3 VGA Parameter

Overscan Setting

When there is black border, you can shield the borders for better image quality.

Enter **Menu** → **Overscan Setting** → **Overscan** to turn it on. You can set **Left Edge**, **Right Edge**, **Top Edge** and **Bottom Edge** from 0 to 100.

| | |
|-------------|-----|
| Overscan | Off |
| Left Edge | 0 |
| Right Edge | 0 |
| Top Edge | 0 |
| Bottom Edge | 0 |

Figure 2-4 Overscan Setting

Note

The value of overscan is the pixel value of certain edge.

Aspect

Enter **Menu** → **Display Setting** . You can set **Aspect** as **16: 9**, **4:3**, or **1: 1** to adjust the display ratio.

| | |
|------------|--------|
| Aspect | 16:9 |
| Light Mode | Normal |

Figure 2-5 Aspect

Light Mode

You can adjust **Light Mode** to adapt different lighting conditions.

Enter **Menu** → **Display Setting** .

Normal

Suitable for the normal light condition.

Night

Suitable for the night condition. The No. represents the intensity of the brightness. 1 means weak, 2 means medium, and 3 means strong.

Sun

Suitable for the daylight condition. The No. represents the intensity of the brightness. 1 means weak, 2 means medium, and 3 means strong.

Image Freeze

Image freeze refers to freeze the current image on screen.

Enter **Menu** → **Other Settings** , and then press ◀ or ▶ to set **Image Freeze** as **Yes**.

Note

After switching the input source, the image freeze is automatically disabled by default.

No Signal

When the monitor dose not have signal input for a long time, it will enter **No Signal** mode.

Enter **Menu** → **Other Settings** , and then press ◀ or ▶ to set **No Signal** as **Blue**, **Black**, or **LOGO**.

2.3 Configure Audio Settings

You can switch the mute on/off, and adjust the volume/balance.

Enter **Menu** → **Audio Setting** , and then press ◀ or ▶ to set the mute, volume, and balance.

| | |
|-----------------|-----|
| Mute | Off |
| Volume Setting | 30 |
| Balance Setting | 0 |

Figure 2-6 Audio Settings

2.4 Configure Screen ID

When you have a number of monitors, setting screen ID to monitors would help you to identify each monitor.

2.4.1 Manually Configure Screen ID

Steps

1. Enter **Menu** → **ID Setting** .
2. Select **Configuration Mode** as **Manual**.

| | |
|--------------------|--------|
| Configuration Mode | Manual |
| Rows | 1 |
| Columns | 1 |
| Auto Config | |

Figure 2-7 Configure Screen ID (Manual)

3. Set **Rows** and **Columns** as you required.
4. Press **OK**.

Example

If you set **Rows** as **2**, and **Columns** as **3**, the screen ID would be 0203.

2.4.2 Automatically Configure Screen ID

Steps

1. Enter **Menu** → **ID Setting** .
2. Set **Configuration Mode** as **Auto**.

| | |
|--------------------|------|
| Configuration Mode | Auto |
| Total Rows | 1 |
| Total Columns | 1 |
| Auto Config | |

Figure 2-8 Configure Screen ID (Auto)

3. Set **Total Rows** and **Total Columns**. The screen ID will be allocated as the order below.

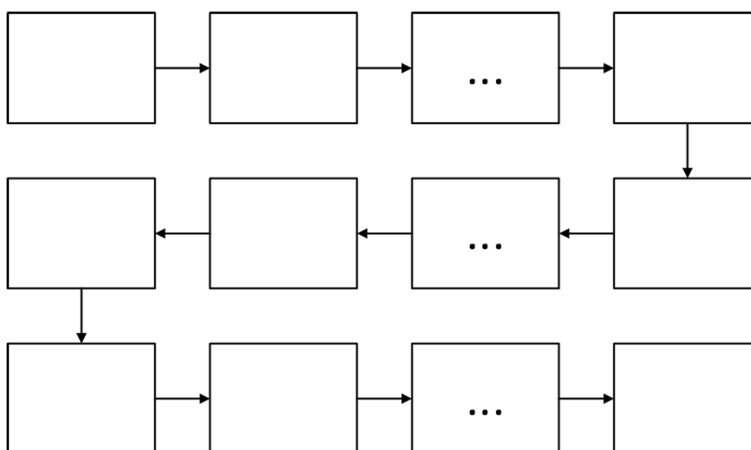

Figure 2-9 Screen ID Order

4. Select **Auto Config**.
5. Press **OK**.

2.5 Configure Overheat Alarm

When the board temperature exceeds or equals its set value, it will trigger an overheat alarm.

Steps

1. Enter **Menu** → **Alarm Setting** .

| | |
|-----------------|-----|
| Overheat Alarm | Off |
| Alarm Temp (°C) | 60 |

Figure 2-10 Overheat Alarm

2. Enable **Overheat Alarm**.
3. Set **Alarm Temp (° C)** as your desire.
4. Press **OK**.

2.6 Menu Interface Settings

You can set language, OSD duration, and OSD blending.

Enter **Menu** → **OSD Setting** .

| | |
|--------------|-----------|
| Language | English |
| OSD Duration | Always On |
| OSD Blending | Medium |

Figure 2-11 Menu Interface Settings

Language

Chinese and English are available.

OSD Duration

The OSD display time when you stopping operating the monitor.

OSD Blending

The OSD transparency.

2.7 Power Settings

You can set **Auto Sleep**, **Low Energy** and **No Signal** to make power plan.

Enter **Menu** → **Other Setting** .

| | |
|-----------------|------|
| Upgrade (USB) | |
| Restore Default | |
| Auto Sleep | Off |
| Low Energy | Off |
| Energy Diagram | Off |
| Image Freeze | Off |
| No Signal | Blue |
| Keypad | Off |

Figure 2-12 Power Settings

Auto Sleep

When the monitor does not have signal input in a preset time, it will automatically go to sleep.

Low Energy

It reduces screen brightness and power consumption to save power.

Energy Diagram

Energy diagram displays power information on the top left of the screen.

Real-time Power

The current power consumption of the device.

Power Percentage

The ratio of **Real-time Power** divided by the total power.

Accumulated Power

It sums all the power **Low Energy** mode has saved.

2.8 System Maintenance

You can view system information, upgrade system, restore default settings, etc.

View System Information

Enter **Menu** → **System Info** to view software version, working time, device ID, and current temperature..

Upgrade System

Enter **Menu** → **Other Setting** . Press **Upgrade (USB)** to upgrade system via USB interface.

Restore Default Settings

Enter **Menu** → **Other Setting** . Press **Restore Default** to restore all parameters to default settings.

Chapter 3 Client Operations

You can turn on/off the monitor, switch input signal through the ScreenControl client.

3.1 Log into the Client

Before You Start

Obtain the ScreenControl software from CD-ROM, and install it.

Steps

1. Double-click the client software shortcut to open it.
2. Select **Control Mode** as **serial port**.
3. Select **Screen Type** as **LCD-D50/4K**.
4. Select **User Name** as **guest**.
5. Click **Login** to log into the client software.

3.2 Configure Serial Port

The client controls the screen by connecting the serial port.

Steps

1. Click **System Configuration** → **Serial Port Configuration** .
2. Set **Serial Port** according to the actual circumstance.
3. Select **Baud Rate** as **9600**.
4. Click **Open** to connect the serial port.
5. **Optional:** Click **Close** to disconnect the serial port.



3.3 Startup/Shutdown

You can turn on/off the monitors via the client.

Before You Start

Configure the serial port, and see [***Configure Serial Port***](#) for details.

Steps

1. Open the Screen Control page.
2. Hold the mouse to draw a rectangle to select one or multiple virtual screens.
3. Turn on/off the monitors.
 - Right click to select Startup/Shutdown.
 - Click  to turn off the monitors. Or click  to turn on the monitors.

3.4 Switch Input Source

You can switch the input source via the client.

Before You Start

Configure the serial port, and see [***Configure Serial Port***](#) for details.

Steps

1. Open the Screen Control page.
2. Hold the mouse to draw a rectangle to select one or multiple virtual screens.
3. Right click and select Switch Signal.
4. Select the source according to your needs.



See Far, Go Further